

QUALITY POLICY : CUSTOMER'S SATISFACTION

MISSION STATEMENT : TO BECOME TOP MOST MEDICAL COMPANY IN PAKISTAN

Brief History of the company: Fizza Surgical International has made revolutionary changes in its manufacturing procedures from hand-made to modern machinery during the last 3 decades. Highly skilled workers are Proficiently working on these machinery multiplying production figures on one hand and having improved the quality of products to entire satisfaction of the customers.

Materials used in production : The materials used in production of these medical instruments conform to internationally recognized standards; viz. Grade AISI-410, Grade AISI-420 and Grade AISI-304. We use Japanese, German and French stainless steels.



## COMPANY PROFILE

Company name : FIZZA SURGICAL INTERNATIONAL

Company address : NARGATE STREET, JINNAH PARK , COLONY #2,,  
Sialkot – 51310 Pakistan

PHONE : +92-52-460 4164

FAX : +92-52-458 0014

E-MAIL : [info@fizzasurgical.com](mailto:info@fizzasurgical.com)

Web site : [www.fizzasurgical.com](http://www.fizzasurgical.com)

LEGAL STATUS OF COMPANY : Partnership

PERSON TO CONTACT : NAJAF ALI  
DESIGNATION : Partner  
[info@fizzasurgical.com](mailto:info@fizzasurgical.com)

PERSON TO CONTACT : NAJAM ALI  
DESIGNATION : Partner  
[Najam.Ali@fizzasurgical.com](mailto:Najam.Ali@fizzasurgical.com)

PERSON TO CONTACT : ALI HASSAN  
DESIGNATION : Partner  
[Ali.Hassan@fizzasurgical.com](mailto:Ali.Hassan@fizzasurgical.com)

Products manufacture: GYNECOLOGY INSTRUMENTS, ALL TYPE OF SCISSORS,  
RFORCEPS AND ETRACTORS etc.

O.E.M. We can produce any type of vaginal speculums, retractors, dilators  
Forceps, Scissors etc.  
Also on O.E.M. basis if the drawings or Master samples are  
provided To us by the customer.

Areas of Exports : Germany, France, Japan, U.K. etc.

CERTIFICATION : ISO 9001 : 2008  
ISO 13485 : 2003  
CE CERTIFICATION BY MHRA – UK  
EC DECLARATION OF CONFORMITY

**Amputations- und Resektionssägen**  
*Amputating and resection saws*  
*Scies à amputation et résection*  
*Sierra para amputación y resección*  
*Seghe per amputazione*



**CHARRIERE**

350 mm - 13<sup>3</sup>/<sub>4</sub>"

BS 14-10-00



12 mm

BS 14-10-01

15 mm

BS 14-10-02

Ersatzsägeblätter  
*Spare saw blades*



**HELFERICH - BIER**

390 mm - 15<sup>1</sup>/<sub>2</sub>"

BS 14-15-00



3 mm

BS 14-15-01

5 mm

BS 14-15-02

7 mm

BS 14-15-03

Ersatzsägeblätter  
*Spare saw blades*

**Amputations- und Resektionssägen**  
*Amputating and resection saws*  
*Scies à amputation et résection*  
*Sierra para amputación y resección*  
*Seghe per amputazione*



1:2

**SATTERLEE**

310 mm – 12¼"

**BS 14-20-01**



1:2

**LANGENBECK**

230 mm – 9"

**BS 14-25-01**



**CHARRIERE**

270 mm – 10¾"

**BS 14-30-01**

300 mm – 12"

**BS 14-30-02**

340 mm – 13½"

**BS 14-30-03**

Raspeln, Feilen  
*Rasps, files*  
*Râpes, limes*  
*Escofinas, limas*  
*Raspe, lime*

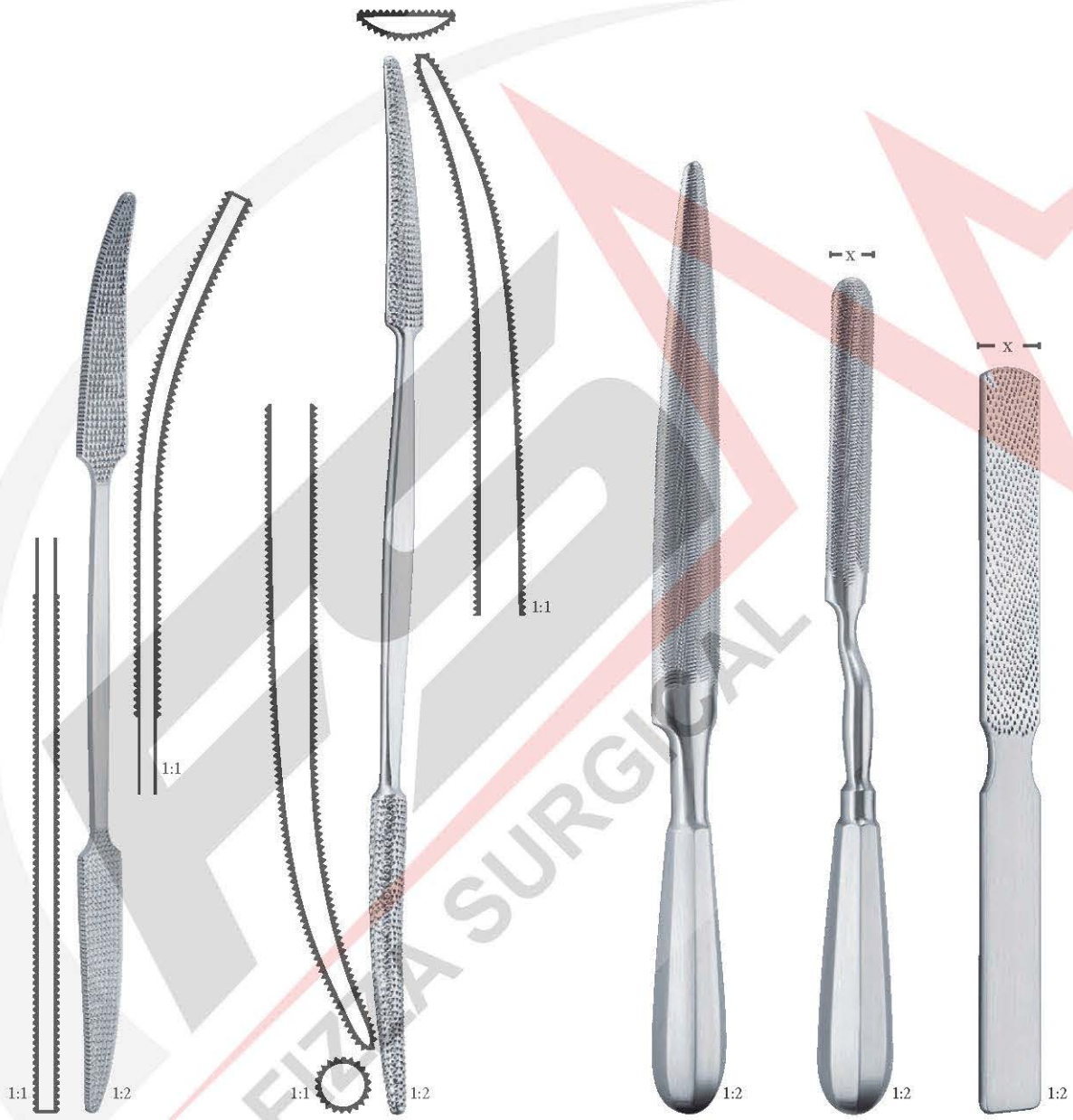

**PUTTI**

270 mm – 10 <sup>3</sup> / <sub>4</sub> "	BS 14-30-01	BS 14-31-01
300 mm – 12"	BS 14-30-02	BS 14-31-02

280 mm – 11"	BS 14-35-01
--------------	-------------

245mm – 9 <sup>3</sup> / <sub>4</sub> "	x = 13 mm	BS 14-36-01
---	-----------	-------------

220mm – 8 <sup>3</sup> / <sub>4</sub> "	x = 20 mm	BS 14-37-01
---	-----------	-------------

halbrund  
*semicircular*

halbrund  
*semicircular*

flach  
*flat*

Hämmer ;Mallets  
Maillets ;Martillos  
Martelli



**DOYEN**

	195 mm - 7 <sup>3</sup> / <sub>4</sub> "
25 mm Ø - 120 g	BS 14-40-01
30 mm Ø - 180 g	BS 14-40-02
35 mm Ø - 260 g	BS 14-40-03



**COLLIN**

	200 mm - 8"
30 mm Ø - 220 g	BS 14-45-01

1:2



**HAJEK**

	215 mm - 8 <sup>1</sup> / <sub>2</sub> "
27 mm Ø - 140 g	BS 14-50-01

1:2



**KIRK**

	190 mm - 7 <sup>1</sup> / <sub>2</sub> "
38 mm Ø - 750 g	BS 14-55-01

1:2



**PARTSCH**

	180 mm - 7"
22 mm Ø - 200 g	BS 14-55-01

1:2



**LUCANE**

	190 mm - 7 <sup>1</sup> / <sub>2</sub> "
19 mm Ø - 230 g	BS 14-60-01
25 mm Ø - 260 g	BS 14-60-02

1:2

Hämmer ;Mallets  
Maillets ;Martillos  
Martelli



1:2  
**BERGMANN**  
245 mm – 9¾"  
45 mm Ø – 300 g  
**BS 14-65-01**



1:2  
**OMBREDANNE**  
240 cm – 9½"  
40 mm Ø – 550 g  
**BS 14-70-01**



**HEATH**

40 mm Ø – 700 g	180 mm – 7"	<b>BS 14-75-01</b>
45 mm Ø – 1000 g	200 mm – 8"	<b>BS 14-75-02</b>

Kupferfüllung  
Copper filled head

**Hämmer ;Mallets  
Maillets ;Martillos  
Martelli**



1:2

190 mm - 7½"
250 mm Ø - 205 g
<b>BS 14-80-01</b>

*Solid steel, with plastic faces*

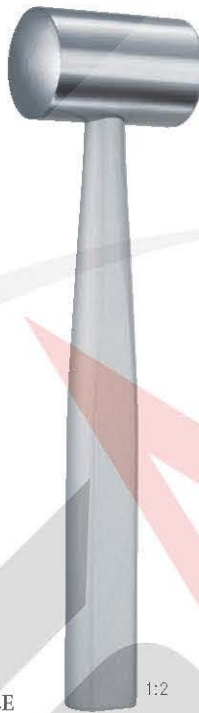

1:2

<b>COTTLE</b>
185 mm - 7¼"
30 mm Ø - 240 g
<b>BS 14-85-01</b>

*1 side flat / 1 side convex*



**WILLIGER**

240 mm - 9½"
28 mm Ø - 340 g
<b>BS 14-90-01</b>
30 mm Ø - 400 g
<b>BS 14-90-02</b>

*lead filled*



1:2

<b>WILLIGER</b>
165 mm - 6½"
20 mm Ø - 140 g
<b>BS 14-95-01</b>



1:2

<b>MEAD</b>
170 mm - 6¾"
26 mm Ø - 320 g
<b>BS 14-100-01</b>

*Stahl massiv, mit Kunststoffbacken  
Steel solid, with plastic faces*



**Knochenhebel ; Leviers à os**  
**Elevadores para huesos**  
**Elevatori per ossa**



HOHMANN

220 mm – 8 <sup>3</sup> / <sub>4</sub> "	240 mm – 9 <sup>1</sup> / <sub>2</sub> "	240 mm – 9 <sup>1</sup> / <sub>2</sub> "	240 mm – 9 <sup>1</sup> / <sub>2</sub> "
x = 8 mm	x = 18 mm	x = 43 mm	x = 70 mm
BS 14-125-01	BS 14-126-01	BS 14-127-01	BS 14-128-01

**Knochenhebel ; Leviers à os**  
**Elevadores para huesos**  
**Elevatori per ossa**



**HOHMANN**

245 mm - 9¾"	260 mm - 10¼"	280 mm - 11"	265 mm - 10½"	260 mm - 10¼"
x = 43 mm	x = 22 mm	x = 33 mm	x = 24 mm	x = 22 mm
<b>BS 14-129-01</b>	<b>BS 14-130-01</b>	<b>BS 14-131-01</b>	<b>BS 14-132-01</b>	<b>BS 14-133-01</b>

**Knochenhebel ; Leviers à os**  
**Elevadores para huesos**  
**Elevatori per ossa**



**MINI - HOHMANN**

	6 mm	8 mm
160 mm - 6 <sup>1</sup> / <sub>4</sub> "	BS 14-135-01	BS 14-136-01

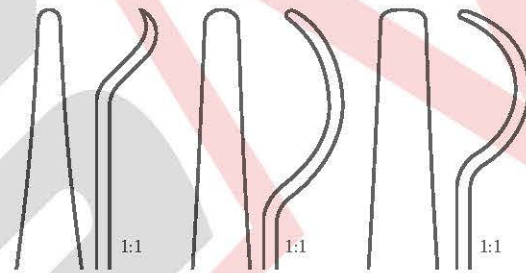
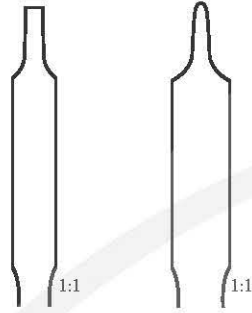

	2.8 mm	4.5 mm	6 mm
140 mm - 5 <sup>1</sup> / <sub>2</sub> "	BS 14-140-01	BS 14-141-01	BS 14-142-01



**BRISTOW**

230 mm - 9"	BS 14-145-01
-------------	--------------

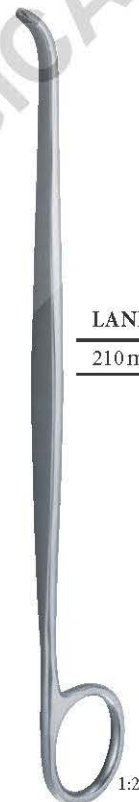

**LANE**

210 mm - 8 <sup>1</sup> / <sub>4</sub> "	BS 14-150-01
--	--------------

**Knochenhebel ; Leviers à os**  
**Elevadores para huesos**  
**Elevatori per ossa**

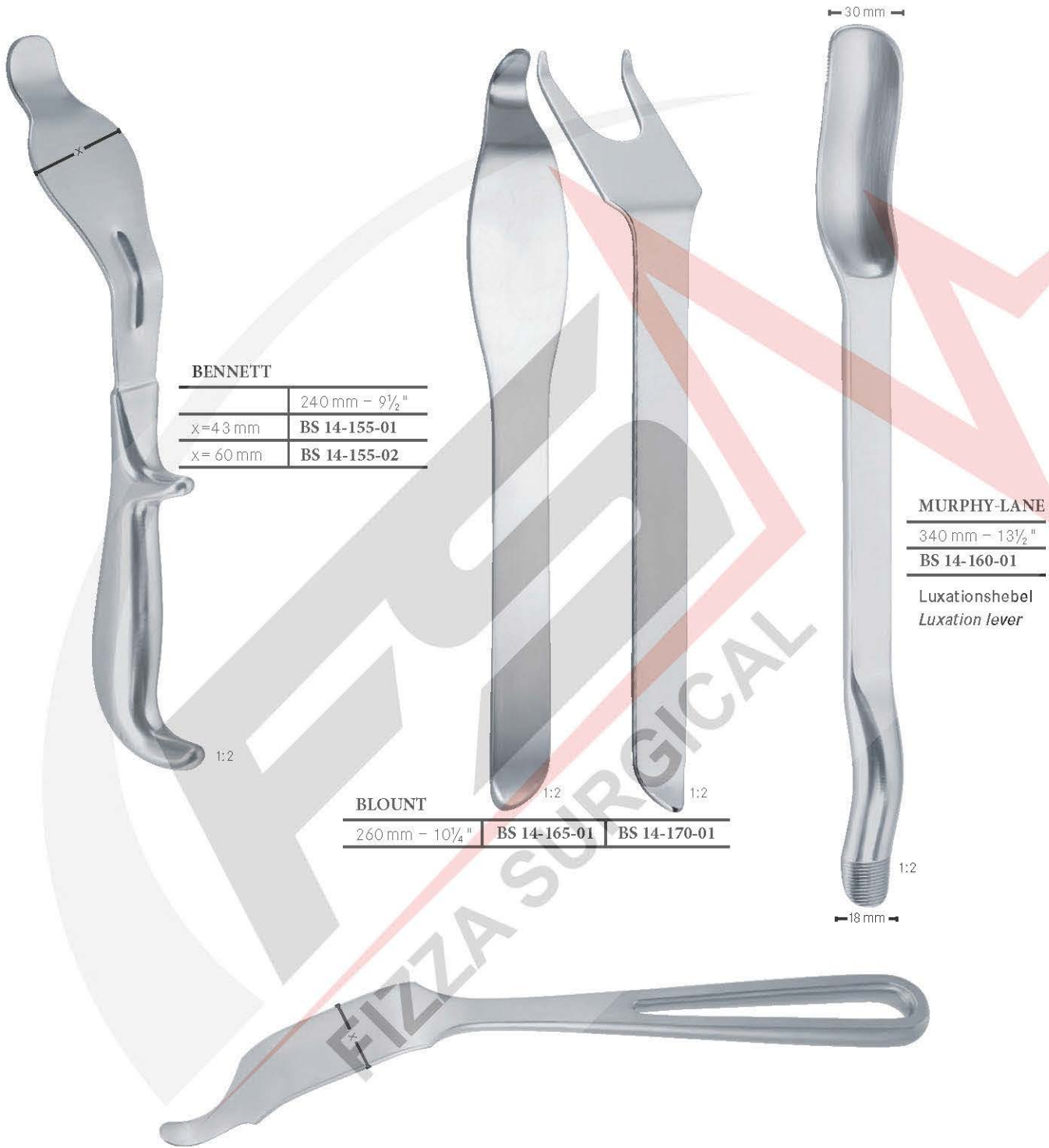

**BENNETT**

	240 mm - 9½"
x=43 mm	BS 14-155-01
x= 60 mm	BS 14-155-02

1:2

**BLOUNT**

260 mm - 10¼"	BS 14-165-01	BS 14-170-01
---------------	--------------	--------------

1:2

1:2

**MURPHY-LANE**

340 mm - 13½"
BS 14-160-01

Luxationshebel  
Luxation lever

1:2

**LANGE -  
HOHMANN MOD.**

265 mm - 10½"	280 mm - 11"
x= 30 mm	x= 33 mm
BS 14-175-01	BS 14-175-02

**Knochenhebel ; Leviers à os  
Elevadores para huesos  
Elevatori per ossa**



**HOHMANN-  
WILLIGER**

160 mm – 6¼"

**BS 14-180-01**

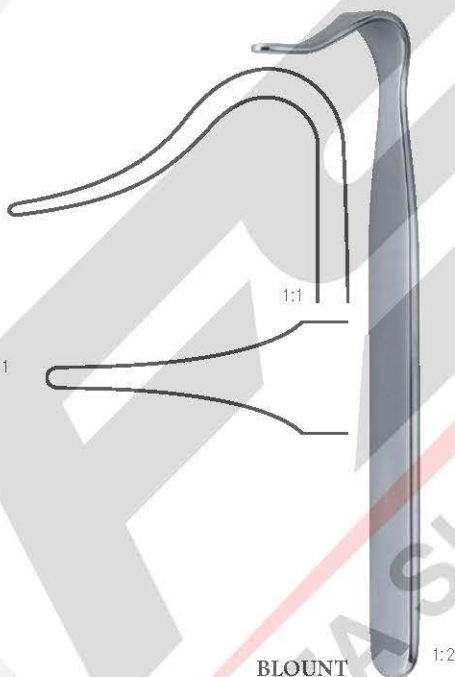

**BLOUNT**

175 mm – 7"

**BS 14-185-01**



**TAYLOR**

	165 mm – 6½"
--	--------------

a = 75 mm – b = 30 mm	<b>BS 14-190-01</b>
-----------------------	---------------------

a = 100 mm – b = 30 mm	<b>BS 14-190-02</b>
------------------------	---------------------

**Knochenmeißel**  
**Ciseaux-burins, gouges**  
**Cinceles, gubias**  
**Scalpelli, sgorbi**

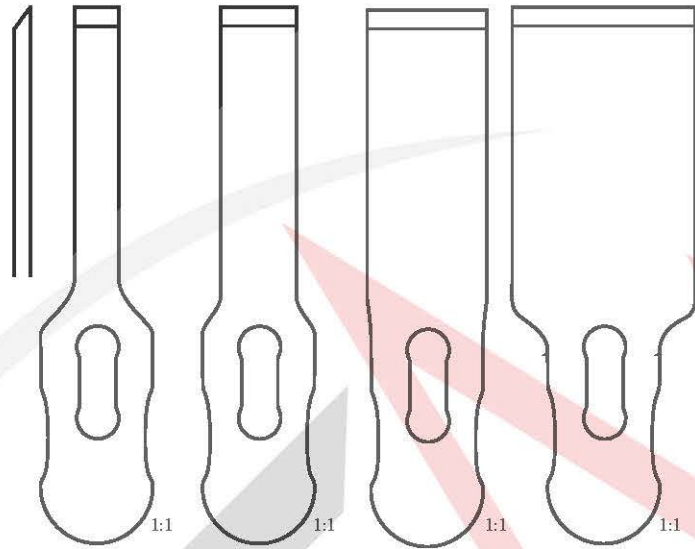

	5mm	10 mm	16mm	25mm
85 mm - 3 1/4"	BS 14-195-01	BS 14-195-02	BS 14-195-03	BS 14-195-04

*Chisel blades, interchangeable*



1:2

185 mm - 7 1/4"

BS 14-195-00

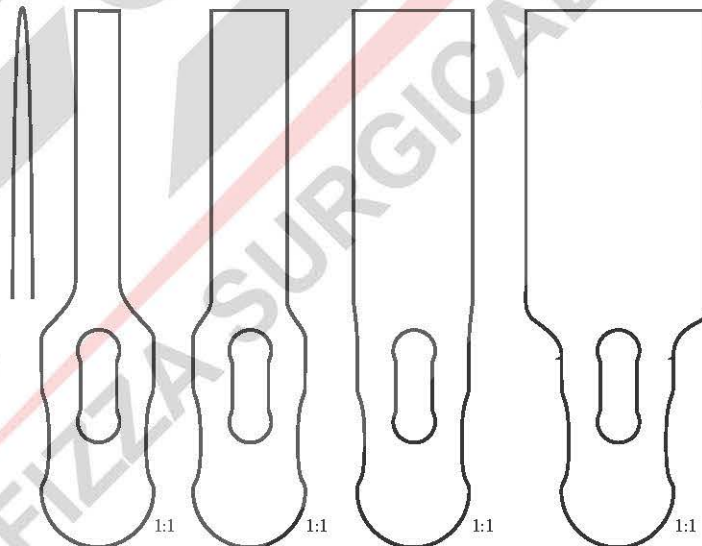

	5mm	10 mm	16mm	25mm
85 mm - 3 1/4"	BS 14-195-05	BS 14-195-06	BS 14-195-07	BS 14-195-08

*Osteotome blades, interchangeable*



1:2

90 mm - 3 1/2"

BS 14-200-01

**Spannschlüssel**  
**Key**

**Knochenmeißel**  
**Ciseaux-burins, gouges**  
**Cinceles, gubias**  
**Scalpelli, sgorbi**

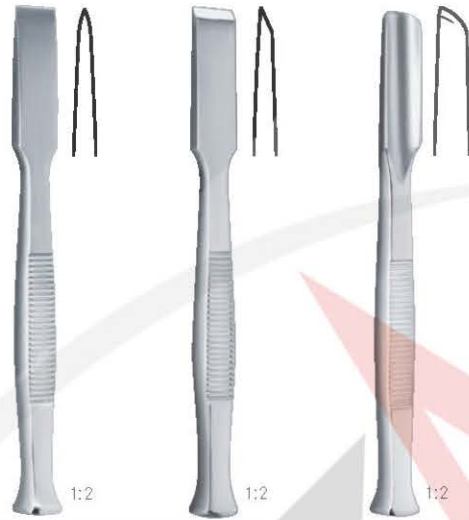

	135 mm – 5¼"	135 mm – 5¼"	135 mm – 5¼"
8 mm	BS 14-205-01	BS 14-206-01	BS 14-207-01
10 mm	BS 14-205-02	BS 14-206-02	BS 14-207-02
12 mm	BS 14-205-03	BS 14-206-03	BS 14-207-03
14 mm	BS 14-205-04	BS 14-206-04	BS 14-207-04
16 mm	BS 14-205-05	BS 14-206-05	BS 14-207-05



**LUCAS**

	160 mm – 6¼"	160 mm – 6¼"
3 mm	BS 14-210-01	BS 14-211-01
4 mm	BS 14-210-02	BS 14-211-02
5 mm	BS 14-210-03	BS 14-211-03
6 mm	BS 14-210-04	BS 14-211-04

*Chisel*

*Gouge*



**ALEXANDER**

	180 mm – 7"	180 mm – 7"
4 mm	BS 14-215-01	BS 14-216-01
6 mm	BS 14-215-02	BS 14-216-02
8 mm	BS 14-215-03	BS 14-216-03
10 mm	BS 14-215-04	BS 14-216-04
12 mm	BS 14-215-05	BS 14-216-05
14 mm	BS 14-215-06	BS 14-216-06

**Knochenmeißel**  
**Ciseaux-burins, gouges**  
**Cinceles, gubias**  
**Scalpelli, sgorbi**



**PARTSCH**

	115 mm - 4½"	135 mm - 5¼"	170 mm - 6¾"
2 mm	BS 14-220-01	BS 14-221-01	BS 14-222-01
3 mm	BS 14-220-02	BS 14-221-02	BS 14-222-02
4 mm	BS 14-220-03	BS 14-221-03	BS 14-222-03
5 mm	BS 14-220-04	BS 14-221-04	BS 14-222-04
6 mm	BS 14-220-05	BS 14-221-05	BS 14-222-05
7 mm	BS 14-220-06	BS 14-221-06	BS 14-222-06
8 mm	BS 14-220-07	BS 14-221-07	BS 14-222-07

	115 mm - 4½"	135 mm - 5¼"	170 mm - 6¾"
	BS 14-225-01	BS 14-226-01	BS 14-227-01
	BS 14-225-02	BS 14-226-02	BS 14-227-02
	BS 14-225-03	BS 14-226-03	BS 14-227-03
	BS 14-225-04	BS 14-226-04	BS 14-227-04
	BS 14-225-05	BS 14-226-05	BS 14-227-05
	BS 14-225-06	BS 14-226-06	BS 14-227-06
	BS 14-225-07	BS 14-226-07	BS 14-227-07



**Knochenmeißel**  
**Ciseaux-burins, gouges**  
**Cinceles, gubias**  
**Scalpelli, sgorbi**



**LAMBOTTE**

	250 mm – 9¾"	250 mm – 9¾"
6 mm	BS 14-230-01	BS 14-231-01
8 mm	BS 14-230-02	BS 14-231-02
10 mm	BS 14-230-03	BS 14-231-03
13 mm	BS 14-230-04	BS 14-231-04
15 mm	BS 14-230-05	BS 14-231-05
20 mm	BS 14-230-06	BS 14-231-06
25 mm	BS 14-230-07	BS 14-231-07
30 mm	BS 14-230-08	BS 14-231-08
38 mm	BS 14-230-09	BS 14-231-09
44 mm	BS 14-230-10	BS 14-231-10
50 mm	BS 14-230-11	BS 14-231-11



**MINI-LAMBOTTE**

	125 mm – 5"	170 mm – 6¾"
3 mm	BS 14-235-01	BS 14-236-01
4 mm	BS 14-235-02	BS 14-236-02
6 mm	BS 14-235-03	BS 14-236-03
8 mm	BS 14-235-04	BS 14-236-04
10 mm	BS 14-235-05	BS 14-236-05
12 mm	BS 14-235-06	BS 14-236-06
15 mm	BS 14-235-07	BS 14-236-07

**Knochenmeißel**  
**Ciseaux-burins, gouges**  
**Cinceles, gubias**  
**Scalpelli, sgorbi**



**LEXER**

	220 mm – 8¾"	300 mm – 12"	220 mm – 8¾"	300 mm – 12"
7 mm	BS 14-240-01	BS 14-241-01	BS 14-242-01	
10 mm	BS 14-240-02	BS 14-241-02	BS 14-242-02	
15 mm	BS 14-240-03	BS 14-241-03	BS 14-242-03	
20 mm	BS 14-240-04	BS 14-241-04	BS 14-242-04	
25 mm	BS 14-240-05	BS 14-241-05	BS 14-242-05	
30 mm	BS 14-240-06	BS 14-241-06	BS 14-242-06	

*Ferrozell handle*

**MINI-LEXER**

	180 mm – 7"	180 mm – 7"
4 mm	BS 14-245-01	BS 14-246-01
6 mm	BS 14-245-02	BS 14-246-02
8 mm	BS 14-245-03	BS 14-246-03
10 mm	BS 14-245-04	BS 14-246-04
12 mm	BS 14-245-05	BS 14-246-05

*Ferrozell handle*

**Knochenmeißel**  
**Ciseaux-burins, gouges**  
**Cinceles, gubias**  
**Scalpelli, sgorbi**



**STILLE**



	200 mm – 8 "	200 mm – 8 "	200 mm – 8 "	200 mm – 8 "	200 mm – 8 "
10 mm	BS 14-250-01	BS 14-251-01	BS 14-252-01	BS 14-253-01	BS 14-254-01
15 mm	BS 14-250-02	BS 14-251-02	BS 14-252-02	BS 14-253-02	BS 14-254-02
20 mm	BS 14-250-03	BS 14-251-03	BS 14-252-03	BS 14-253-03	BS 14-254-03
25 mm	BS 14-250-04	BS 14-251-04	BS 14-252-04	BS 14-253-04	BS 14-254-04

1:2



**SMITH-  
PETERSEN**



	200 mm – 8 "	200 mm – 8 "	200 mm – 8 "	200 mm – 8 "
6 mm	BS 14-255-01	BS 14-256-01	BS 14-257-01	BS 14-258-01
9 mm	BS 14-255-02	BS 14-256-02	BS 14-257-02	BS 14-258-02
13 mm	BS 14-255-03	BS 14-256-03	BS 14-257-03	BS 14-258-03
16 mm	BS 14-255-04	BS 14-256-04	BS 14-257-04	BS 14-258-04
19 mm	BS 14-255-05	BS 14-256-05	BS 14-257-05	BS 14-258-05
25 mm	BS 14-255-06	BS 14-256-06	BS 14-257-06	BS 14-258-06
32 mm	BS 14-255-07	BS 14-256-07	BS 14-257-07	BS 14-258-07

1:2

**Knochenmeißel**  
**Ciseaux-burins, gouges**  
**Cinceles, gubias**  
**Scalpelli, sgorbi**



**HIBBS**

	240mm-9½"	240mm-9½"	240mm-9½"	240mm-9½"	240mm-9½"
6 mm	BS 14-260-01	BS 14-261-01	BS 14-262-01	BS 14-263-01	BS 14-264-01
13 mm	BS 14-260-02	BS 14-261-02	BS 14-262-02	BS 14-263-02	BS 14-264-02
19 mm	BS 14-260-03	BS 14-261-03	BS 14-262-03	BS 14-263-03	BS 14-264-03
25 mm	BS 14-260-04	BS 14-261-04	BS 14-262-04	BS 14-263-04	BS 14-264-04
32 mm	BS 14-260-05	BS 14-261-05	BS 14-262-05	BS 14-263-05	BS 14-264-05

1:2

**Knochenmeißel**  
**Ciseaux-burins, gouges**  
**Cinceles, gubias**  
**Scalpelli, sgorbi**



**FREER**

	150 mm - 6"	160 mm - 6¼"
6 mm	BS 14-265-01	BS 14-266-01
4 mm	BS 14-265-02	BS 14-266-02

*Gouge*

*Chisel*



**BALLENGER**

	160 mm - 6¼"
4 mm	BS 14-270-01
6 mm	BS 14-270-02
8 mm	BS 14-270-03

**MANNERFELT  
MODIF.**

	155 mm - 6"	155 mm - 6"
3 mm	BS 14-275-01	BS 14-276-01
4 mm	BS 14-275-02	BS 14-276-02
6 mm	BS 14-275-03	BS 14-276-03
8 mm	BS 14-275-04	BS 14-276-04

*Osteotomes*

*Gouge*



1:2

Meißel zur Nasenplastik  
 Ostéotomes, ciseaux-burins pour  
 rhinoplastique Cinceles para  
 rinoplastica  
 Scalpelli per plastica nasale

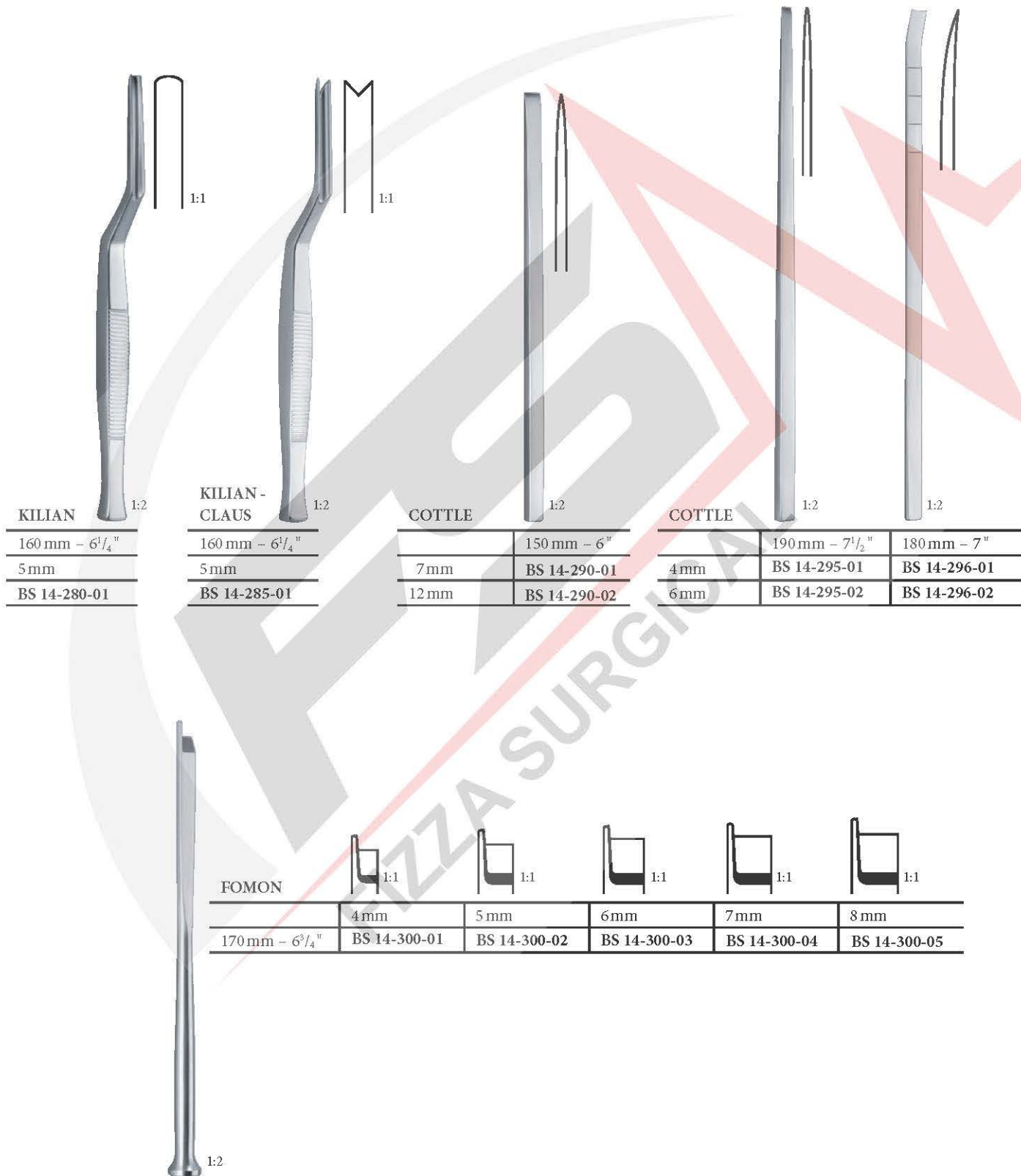

**KILIAN**

160 mm - 6 <sup>1</sup> / <sub>4</sub> "
5 mm
BS 14-280-01

**KILIAN - CLAU**

160 mm - 6 <sup>1</sup> / <sub>4</sub> "
5 mm
BS 14-285-01

**COTTLE**

150 mm - 6"
7 mm
BS 14-290-01
12 mm
BS 14-290-02

**COTTLE**

190 mm - 7 <sup>1</sup> / <sub>2</sub> "	180 mm - 7"
4 mm	6 mm
BS 14-295-01	BS 14-296-01
BS 14-295-02	BS 14-296-02

**FOMON**

170 mm - 6 <sup>3</sup> / <sub>4</sub> "	4 mm	5 mm	6 mm	7 mm	8 mm
	BS 14-300-01	BS 14-300-02	BS 14-300-03	BS 14-300-04	BS 14-300-05

**Meißel zur Nasenplastik**  
**Ostéotomes, ciseaux-burins pour**  
**rhinoplastique Cinceles para**  
**rhinoplastica**  
**Scalpelli per plastica nasale**



**CINELLI**

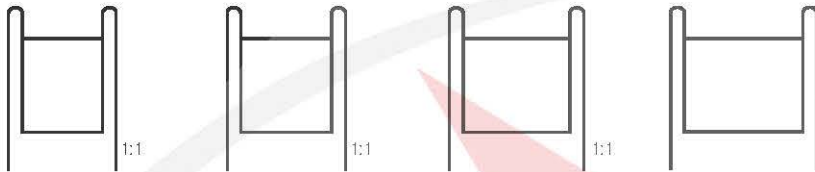

	10 mm	12 mm	14 mm	16 mm
180 mm - 7"	<b>BS 14-305-01</b>	<b>BS 14-305-02</b>	<b>BS 14-305-03</b>	<b>BS 14-305-04</b>



**COTTLE**



	4 mm	7 mm	9 mm	12 mm
180 mm - 7"	<b>BS 14-310-01</b>	<b>BS 14-310-02</b>	<b>BS 14-310-03</b>	<b>BS 14-310-04</b>

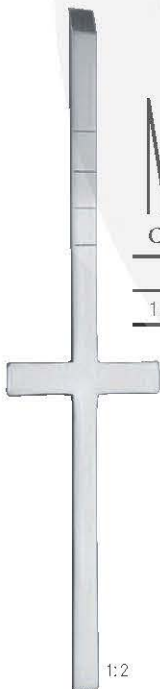

**COTTLE**



	4 mm	7 mm	9 mm	12 mm
180 mm - 7"	<b>BS 14-310-01</b>	<b>BS 14-310-02</b>	<b>BS 14-310-03</b>	<b>BS 14-310-04</b>

**Meißel zur Nasenplastik**  
**Ostéotomes, ciseaux-burins pour**  
**rhinoplastique Cinceles para**  
**rhinoplastica**  
**Scalpelli per plastica nasale**



COTTLE	6 mm	16 mm	16 mm
180 mm - 7"	<b>BS 14-315-01</b>	<b>BS 14-316-01</b>	<b>BS 14-317-01</b>







RUBIN	10 mm	12 mm	14 mm
180 mm - 7"	<b>BS 14-320-01</b>	<b>BS 14-321-01</b>	<b>BS 14-322-01</b>





**Meißel zur Nasenplastik  
Ostéotomes, ciseaux-burins pour  
rhinoplastique Cinceles para  
rhinoplastica  
Scalpelli per plastica nasale**











COTTLE	 1:1	 1:1	 1:1	 1:1
		4 mm	7 mm	9 mm
200 mm – 8"	<b>BS 14-325-01</b>	<b>BS 14-325-02</b>	<b>BS 14-325-03</b>	<b>BS 14-325-04</b>



WALTER	 1:1	 1:1
		3 mm
190 mm – 7½"	<b>BS 14-330-01</b>	<b>BS 14-330-02</b>



SHEEHAN	 1:1	 1:1	 1:1	 1:1
		2 mm	4 mm	6 mm
160 mm – 6¼"	<b>BS 14-335-01</b>	<b>BS 14-335-02</b>	<b>BS 14-335-03</b>	<b>BS 14-335-04</b>

 1:1	 1:1	 1:1	 1:1
10 mm	12 mm	15 mm	18 mm
<b>BS 14-335-05</b>	<b>BS 14-335-06</b>	<b>BS 14-335-07</b>	<b>BS 14-335-08</b>

Meißel zur Nasenplastik  
 Ostéotomes, ciseaux-burins pour  
 rhinoplastique Cinceles para  
 rinoplastica  
 Scalpelli per plastica nasale

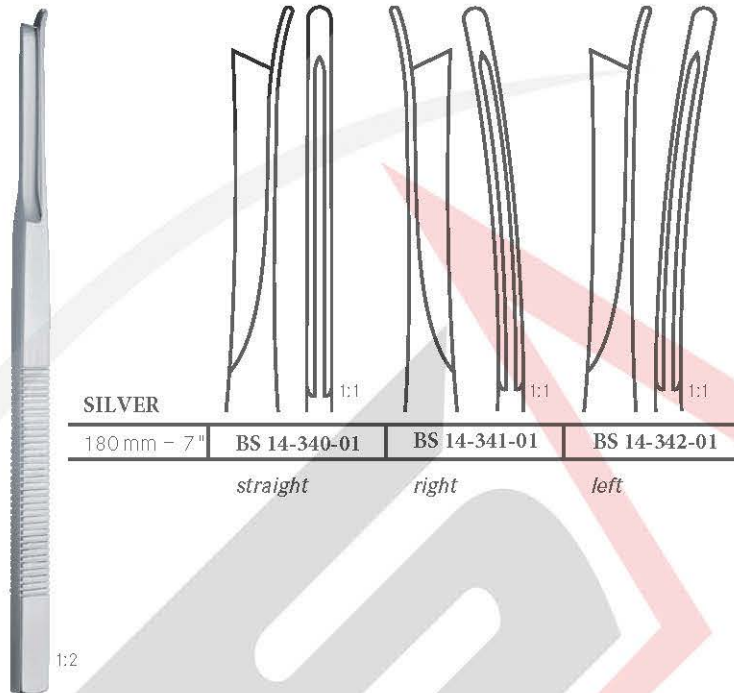

SILVER			
180 mm – 7"	BS 14-340-01	BS 14-341-01	BS 14-342-01
	<i>straight</i>	<i>right</i>	<i>left</i>

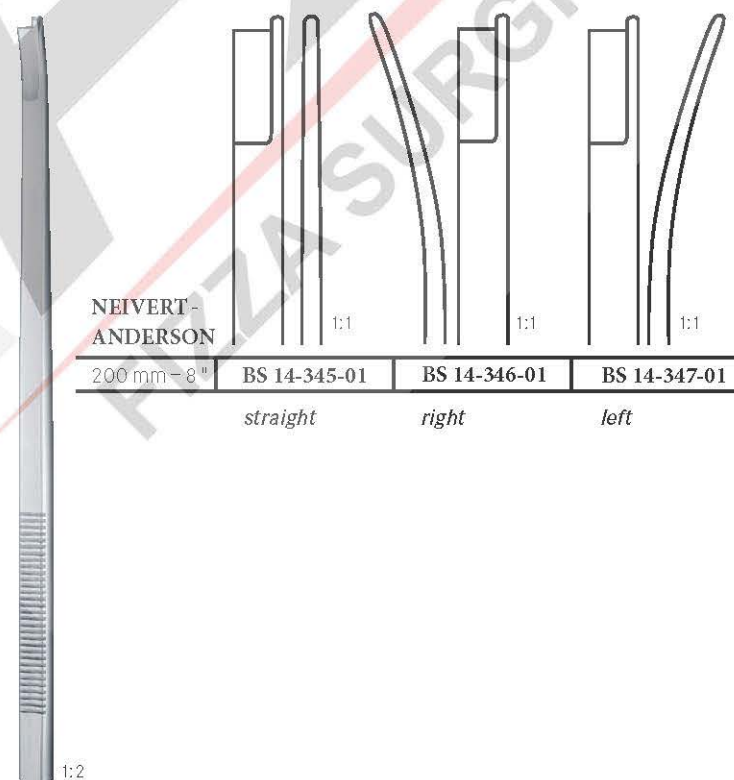

NEIVERT-ANDERSON			
200 mm – 8"	BS 14-345-01	BS 14-346-01	BS 14-347-01
	<i>straight</i>	<i>right</i>	<i>left</i>

**Meißel für die Kieferchirurgie**  
*Ostéotomes pour la chirurgie maxillo-faciale*  
*Cinceles para la cirugía maxilofacial*  
*Scalpelli per chirurgia massilofaciale*



**OBWEGESER**

235 mm – 9<sup>1</sup>/<sub>4</sub>"

11 mm

BS 14-350-01

1:2



1:1

1:2



1:1

1:2







**OBWEGESER**

7 mm	10 mm
215 mm – 8 <sup>1</sup> / <sub>2</sub> "	BS 14-355-01
	BS 14-355-02

Stößel  
Pilons  
Punzones  
Pestoni





1:2

	 1:1	 1:1	 1:1	 1:1	 1:1	 1:1	 1:1
	2 mm Ø	3 mm Ø	4 mm Ø	5 mm Ø	6 mm Ø	8 mm Ø	10 mm Ø
155 mm - 6"	BS 14-360-01	BS 14-360-02	BS 14-360-03	BS 14-360-04	BS 14-360-05	BS 14-360-06	BS 14-360-07





1:2

PASSOW	 1:1	 1:1
	Fig. 1	Fig. 2
	2.5 mm x 2.5 mm	3.5 mm x 3.5 mm
120 mm - 4 3/4"	BS 14-365-01	BS 14-365-02





1:2

CASPAR	 1:1	 1:1	 1:1
	3 mm Ø	5 mm Ø	8 mm Ø
200 mm - 8"	BS 14-370-01	BS 14-370-02	BS 14-370-03













1:2

	 1:1	 1:1	 1:1
	12 mm Ø	14 mm Ø	16 mm Ø
200 mm - 8"	BS 14-370-04	BS 14-370-05	BS 14-370-06





Scharfe Löffel  
Curettes tranchantes  
Cucharillas cortantes  
Cucchiai taglienti





<b>VOLKMANN</b>	 1:1	 1:1	 1:1	 1:1	 1:1
	Fig. 0000	Fig. 000	Fig. 00	Fig. 0	Fig. 1
170mm – 6 <sup>3</sup> / <sub>4</sub> "	BS 14-375-01	BS 14-375-02	BS 14-375-03	BS 14-375-04	BS 14-375-05

 1:1	 1:1	 1:1	 1:1	 1:1
Fig. 2	Fig. 3	Fig. 4	Fig. 5	Fig. 6
BS 14-375-06	BS 14-375-07	BS 14-375-08	BS 14-375-09	BS 14-375-10









<b>SCHUDE</b>	 1:1	 1:1	 1:1	 1:1	 1:1
	Fig. 000	Fig. 00	Fig. 0	Fig. 1	Fig. 2
170 mm – 6 <sup>3</sup> / <sub>4</sub> "	BS 14-380-01	BS 14-380-02	BS 14-380-03	BS 14-380-04	BS 14-380-05



 1:1	 1:1
Fig. 3	Fig. 4
BS 14-380-06	BS 14-380-07

**Scharfe Löffel**  
**Curettes tranchantes**  
**Cucharillas cortantes**  
**Cucchiai taglienti**





<b>SPRATT</b>	 1:1	 1:1	 1:1
	Fig. 0000	Fig. 000	Fig. 00
170 mm – 6 $\frac{3}{4}$ "	<b>BS 14-385-01</b>	<b>BS 14-385-02</b>	<b>BS 14-385-03</b>



 1:1	 1:1	 1:1
Fig. 0	Fig. 1	Fig. 2
<b>BS 14-385-04</b>	<b>BS 14-385-05</b>	<b>BS 14-385-06</b>

 1:1	 1:1	 1:1
Fig. 3	Fig. 4	Fig. 5
<b>BS 14-385-07</b>	<b>BS 14-385-08</b>	<b>BS 14-385-09</b>



<b>BRUNS</b>	 1:1	 1:1	 1:1
	Fig. 000	Fig. 00	Fig. 0
160 mm – 6 $\frac{1}{4}$ "	<b>BS 14-390-01</b>	<b>BS 14-390-02</b>	<b>BS 14-390-03</b>

 1:1	 1:1	 1:1
Fig. 1	Fig. 2	Fig. 3
<b>BS 14-390-04</b>	<b>BS 14-390-05</b>	<b>BS 14-390-06</b>





 1:1	 1:1	 1:1
Fig. 4	Fig. 5	Fig. 6
<b>BS 14-390-07</b>	<b>BS 14-390-08</b>	<b>BS 14-390-09</b>

**Scharfe Löffel**  
**Curettes tranchantes**  
**Cucharillas cortantes**  
**Cucchiai taglienti**



<b>VOLKMANN</b>	 1:1	 1:1	 1:1	 1:1	 1:1	 1:1
	Fig. 0000	Fig. 000	Fig. 00	Fig. 0	Fig. 1	Fig. 2
185 mm – 7¼"	BS 14-395-01	BS 14-395-02	BS 14-395-03	BS 14-395-04	BS 14-395-05	BS 14-395-06



*oval, with plastic handle*

	 1:1	 1:1	 1:1	 1:1
	Fig. 3	Fig. 4	Fig. 5	Fig. 6
190 mm – 7½"	BS 14-396-01	BS 14-396-02	BS 14-396-03	BS 14-396-04

	 1:1	 1:1	 1:1	 1:1	 1:1
	Fig. 0	Fig. 1	Fig. 2	Fig. 3	Fig. 4
275 mm – 10¾"	BS 14-397-01	BS 14-397-02	BS 14-397-03	BS 14-397-04	BS 14-397-05

**Scharfe Löffel**  
**Curettes tranchantes**  
**Cucharillas cortantes**  
**Cucchiai taglienti**





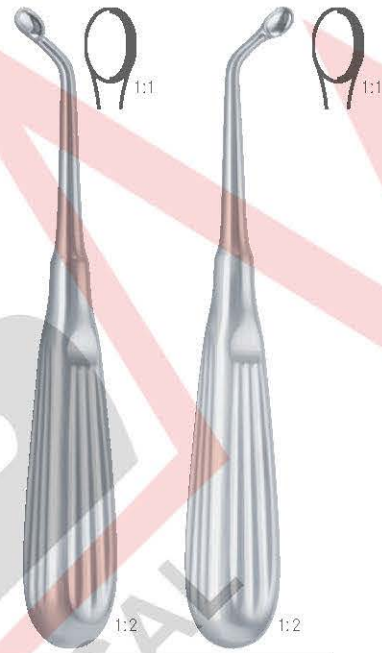

<b>HALLE</b>	 1:1	 1:1	 1:1
	Fig. 1	Fig. 2	Fig. 3
	210 mm – 8 3/4"	<b>BS 14-400-01</b>	<b>BS 14-400-02</b>

*flexible*







<b>UFFENORDE</b>	 1:1	 1:1
	Fig. 1	Fig. 2
	170 mm – 6 3/4"	<b>BS 14-405-01</b>



<b>BRUNS</b>	 1:1	 1:1	 1:1	 1:1
	Fig. 00	Fig. 0	Fig. 1	Fig. 2
	230 mm – 9"	<b>BS 14-410-01</b>	<b>BS 14-410-02</b>	<b>BS 14-410-03</b>

*solid*



 1:1	 1:1	 1:1	 1:1
Fig. 3	Fig. 4	Fig. 5	Fig. 6
<b>BS 14-410-05</b>	<b>BS 14-410-06</b>	<b>BS 14-410-07</b>	<b>BS 14-410-08</b>





**Scharfe Löffel**  
**Curettes tranchantes**  
**Cucharillas cortantes**  
**Cucchiai taglienti**



**SCHROEDER**

	 1:1	 1:1	 1:1
	Fig. 1	Fig. 2	Fig. 3
300 mm – 12"	BS 14-415-01	BS 14-415-02	BS 14-415-03

*sharp / rigid*



 1:1	 1:1	 1:1
Fig. 4	Fig. 5	Fig. 6
BS 14-415-04	BS 14-415-05	BS 14-415-06

**SIMON**



	 1:1	 1:1	 1:1	 1:1
	Fig. 0000	Fig. 000	Fig. 00	Fig. 0
240 mm – 9½"	BS 14-420-01	BS 14-420-02	BS 14-420-03	BS 14-420-04

*sharp / rigid*

**SIMON**

	 1:1	 1:1	 1:1
	Fig. 1	Fig. 2	Fig. 3
250 mm – 9¾"	BS 14-425-01	BS 14-425-02	BS 14-425-03



*sharp / rigid*

 1:1	 1:1	 1:1
Fig. 4	Fig. 5	Fig. 6
BS 14-425-04	BS 14-425-05	BS 14-425-06









Scharfe Löffel  
Curettes tranchantes  
Cucharillas cortantes  
Cucchiai taglienti



	 1:1	 1:1	 1:1
	Fig. 000	Fig. 00	Fig. 0
200 mm – 8"	<b>BS 14-430-01</b>	<b>BS 14-430-02</b>	<b>BS 14-430-03</b>

*straight*



	 1:1	 1:1	 1:1
	Fig. 1	Fig. 2	Fig. 3
	<b>BS 14-430-04</b>	<b>BS 14-430-05</b>	<b>BS 14-430-06</b>



	 1:1	 1:1	 1:1
	Fig. 4	Fig. 5	Fig. 6
	<b>BS 14-430-07</b>	<b>BS 14-430-08</b>	<b>BS 14-430-09</b>



	 1:1	 1:1	 1:1
	Fig. 000	Fig. 00	Fig. 0
200 mm – 8"	<b>BS 14-435-01</b>	<b>BS 14-435-02</b>	<b>BS 14-435-03</b>





*curved*

	 1:1	 1:1	 1:1
	Fig. 1	Fig. 2	Fig. 3
	<b>BS 14-435-04</b>	<b>BS 14-435-05</b>	<b>BS 14-435-06</b>

	 1:1	 1:1	 1:1
	Fig. 4	Fig. 5	Fig. 6
	<b>BS 14-435-07</b>	<b>BS 14-435-08</b>	<b>BS 14-435-09</b>

**Scharfe Löffel**  
**Currettes tranchantes**  
**Cucharillas cortantes**  
**Cucchiai taglienti**



	 1:1	 1:1	 1:1	 1:1
	Fig. 000	Fig. 00	Fig. 0	Fig. 1
	3.6 mm	4.4 mm	5.2 mm	6.8 mm
250 mm – 9 3/4"	<b>BS 14-440-01</b>	<b>BS 14-440-02</b>	<b>BS 14-440-03</b>	<b>BS 14-440-04</b>

*straight*





	 1:1	 1:1	 1:1	 1:1
<b>DAUBENSPECK</b>	Fig. 0000	Fig. 000	Fig. 00	Fig. 0
	2.8 mm	3.6 mm	4.4 mm	5.2 mm
200 mm – 8"	<b>BS 14-445-01</b>	<b>BS 14-445-02</b>	<b>BS 14-445-03</b>	<b>BS 14-445-04</b>





1:2

Scharfe Löffel  
Curettes tranchantes  
Cucharillas cortantes  
Cucchiai taglienti



SCOVILLE	 1:1	 1:1	 1:1
	Fig. 1	Fig. 2	Fig. 3
250 mm – 9¾"	BS 14-450-01	BS 14-450-02	BS 14-450-03
<i>oval</i>			



LEMPERT	 1:1	 1:1	 1:1	 1:1	 1:1
	Fig. 00000	Fig. 0000	Fig. 000	Fig. 00	Fig. 0
	1.8 mm	2.0 mm	2.4 mm	2.6 mm	2.8 mm
215 mm – 8½"	BS 14-455-01	BS 14-455-02	BS 14-455-03	BS 14-455-04	BS 14-455-05

Scharfe Löffel  
Curettes tranchantes  
Cucharillas cortantes  
Cucchiai taglienti

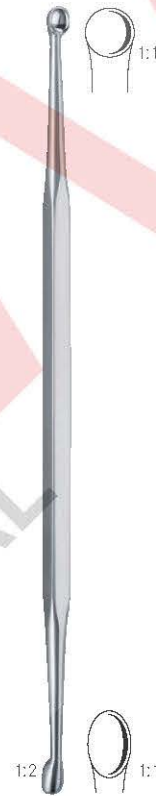

**VOLKMANN**

130 mm - 5"	<b>BS 14-460-01</b>	<b>BS 14-461-01</b>
140 mm - 5½"	<b>BS 14-460-02</b>	<b>BS 14-461-02</b>
160 mm - 6¼"	<b>BS 14-460-03</b>	<b>BS 14-461-03</b>
170 mm - 6¾"	<b>BS 14-460-04</b>	<b>BS 14-461-04</b>
200 mm - 8"	<b>BS 14-460-05</b>	<b>BS 14-461-05</b>

*oval / oval*

*round / oval*



210 mm - 8¼"

**BS 14-465-01**

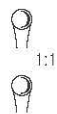

*round / oval*

**Scharfe Löffel**  
**Curettes tranchantes**  
**Cucharillas cortantes**  
**Cucchiai taglienti**

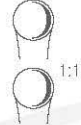



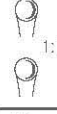

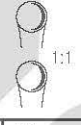
	 1:1	 1:1	 1:1
<b>MARTINI</b>			
	Fig. 00	Fig. 0	Fig. 1
	Fig. 0	Fig. 1	Fig. 2
135 mm – 5¼"	<b>BS 14-470-01</b>	<b>BS 14-470-02</b>	<b>BS 14-470-03</b>



	 1:1	 1:1	 1:1
<b>MARTINI</b>			
	Fig. 00	Fig. 0	Fig. 1
	Fig. 00	Fig. 0	Fig. 1
155 mm – 6"	<b>BS 14-475-01</b>	<b>BS 14-475-02</b>	<b>BS 14-475-03</b>

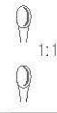
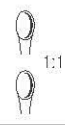

	 1:1	 1:1	 1:1
<b>WILLIGER</b>			
	Fig. 00	Fig. 0	Fig. 1
	Fig. 0	Fig. 1	Fig. 2
135 mm – 5¼"	<b>BS 14-480-01</b>	<b>BS 14-480-02</b>	<b>BS 14-480-03</b>

	 1:1	 1:1	 1:1
<b>WILLIGER</b>			
	Fig. 00	Fig. 0	Fig. 1
	Fig. 00	Fig. 0	Fig. 1
155 mm – 6"	<b>BS 14-485-01</b>	<b>BS 14-485-02</b>	<b>BS 14-485-03</b>

**Raspatorien für die Kieferchirurgie**  
**Rugines – Décolleurs pour la chirurgie maxillo-faciale**  
**Periostótomos para la cirugía maxilofacial**  
**Raspatori per chirurgia massilofaciale**

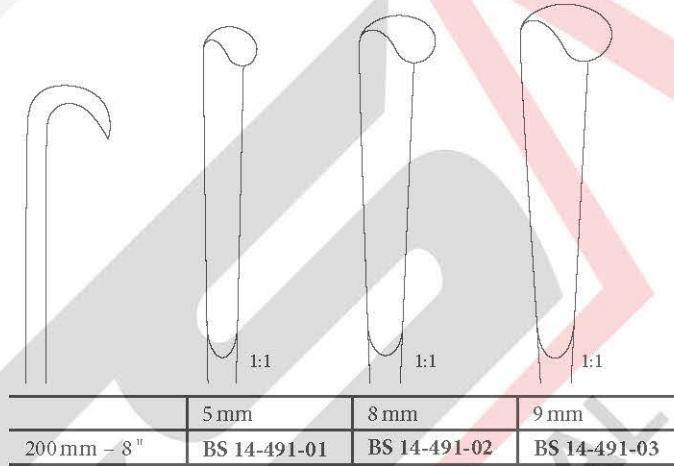
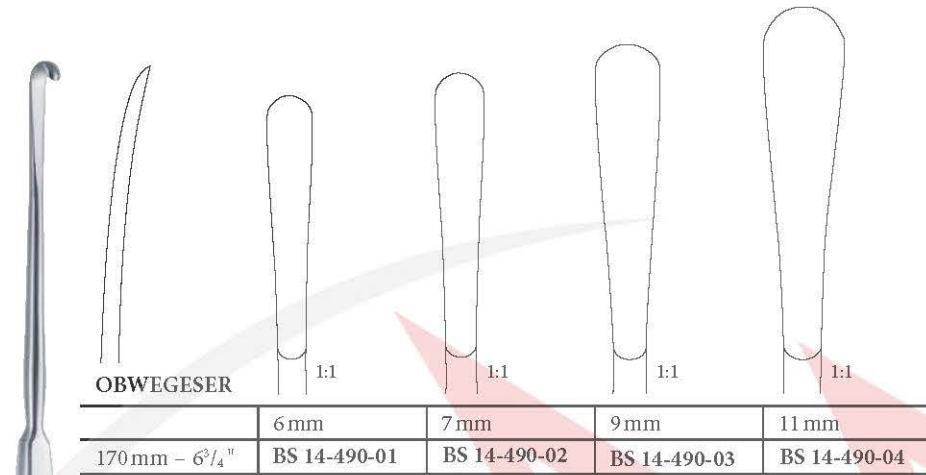

Raspatorien für die Kieferchirurgie  
 Rugines – Décolleurs pour la chirurgie maxillo-  
 faciale Periostótomos para la cirugía maxilofacial  
 Raspatori per chirurgia massilofaciale

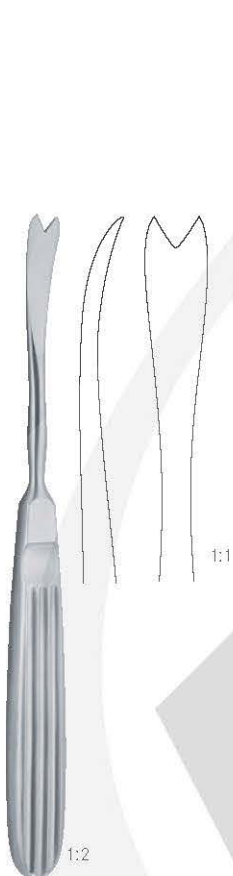

**OBWEGESER**

175 mm – 7"

**BS 14-500-01**



**OBWEGESER**

230 mm – 9"

**BS 14-505-01**



**OBWEGESER**

180 mm – 7"

**BS 14-510-01**



**OBWEGESER**

140 mm – 5½"

**BS 14-515-01**



Raspatorien – Elevatorien  
 Rugines – Elevateurs Raspatorios – Elevadores  
 Periostotomi – Elevatori



DOYEN

170 mm – 6<sup>3</sup>/<sub>4</sub>"

*left*

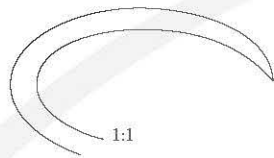

1:1

BS 14-520-01

*for adults*

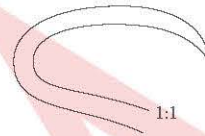

1:1

BS 14-520-01

*for children*

1:2



DOYEN

170 mm – 6<sup>3</sup>/<sub>4</sub>"

*right*



1:1

BS 14-525-01

*for adults*

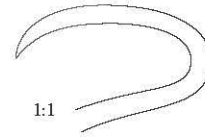

1:1

BS 14-525-02

*for children*

1:2

Raspatorien – Elevatorien  
 Rugines – Elevateurs  
 Raspatorios – Elevadores  
 Periostotomi – Elevatori



<b>QUERVAIN</b>
195 mm – 7 <sup>3</sup> / <sub>4</sub> ''
x = 6 mm
BS 14-530-01

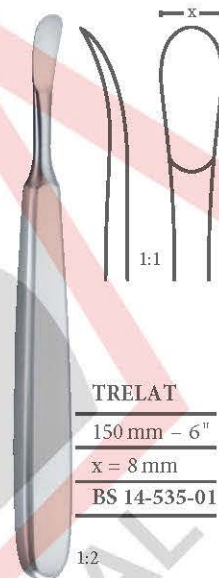

<b>TRELAT</b>
150 mm – 6''
x = 8 mm
BS 14-535-01

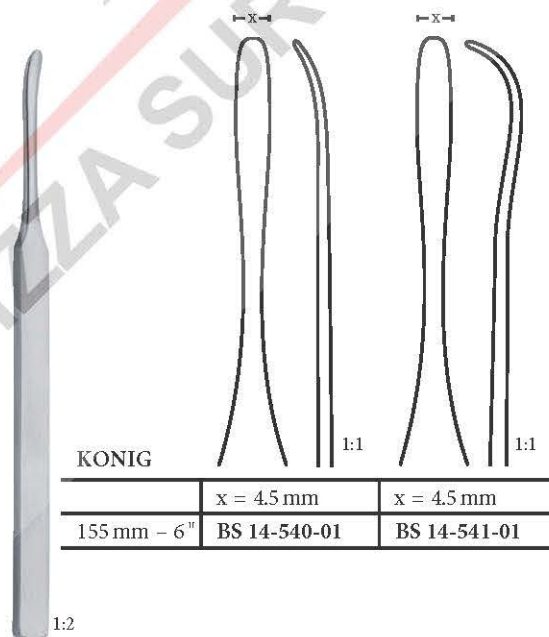

<b>KONIG</b>	x = 4.5 mm	x = 4.5 mm
155 mm – 6''	BS 14-540-01	BS 14-541-01

Raspatorien – Elevatorien  
 Rugines – Elevateurs  
 Raspatorios – Elevadores  
 Periostotomi – Elevatori

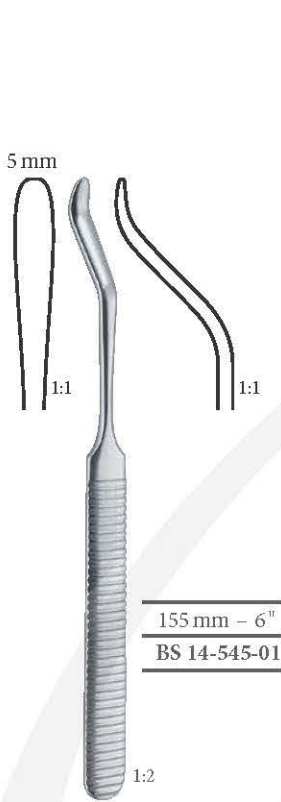

155 mm – 6"  
 BS 14-545-01

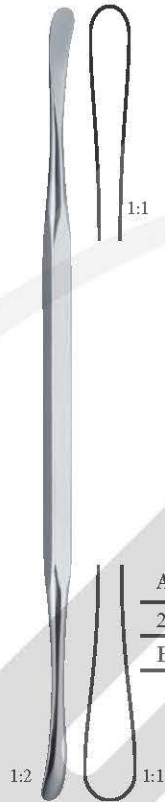

ALDERDYCE  
 210 mm – 8 1/4"  
 BS 14-550-01

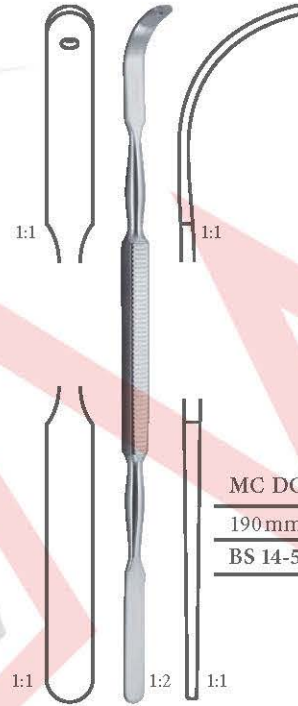

MC DONALD  
 190 mm – 7 1/2"  
 BS 14-555-01

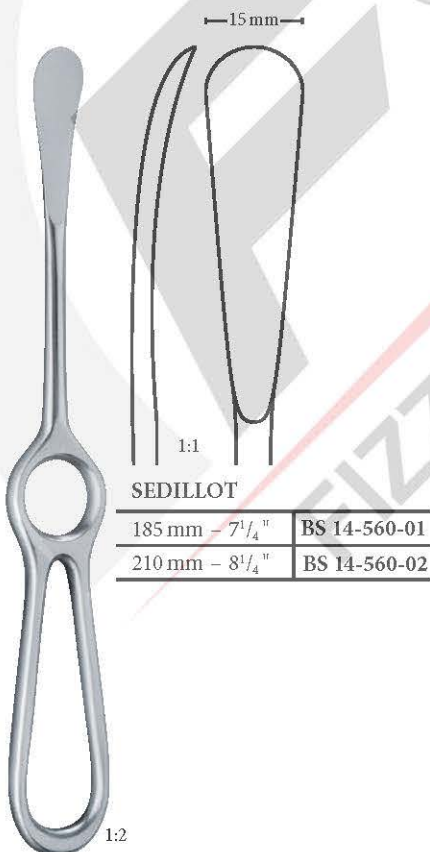

SEDILLOT  
 185 mm – 7 1/4"    BS 14-560-01  
 210 mm – 8 1/4"    BS 14-560-02

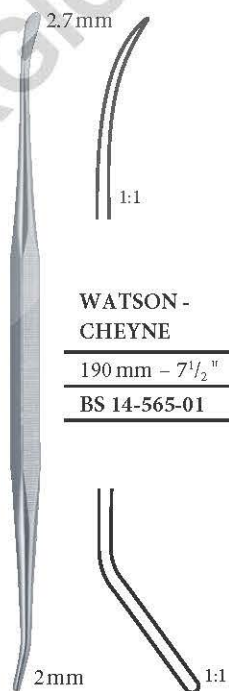

WATSON -  
 CHEYNE  
 190 mm – 7 1/2"  
 BS 14-565-01

Raspatorien - Elevatorien  
 Rugines - Elevateurs  
 Raspatorios - Elevadores  
 Periostotomi - Elevatori

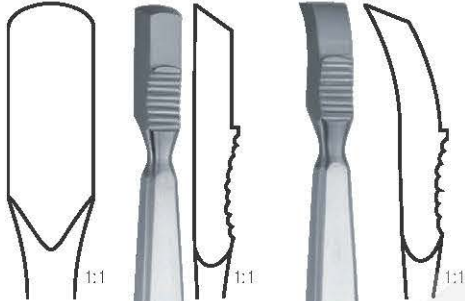

**FARABEUF**

150 mm - 6"	<b>BS 14-570-01</b>	<b>BS 14-571-01</b>
	<i>straight</i>	<i>curved</i>

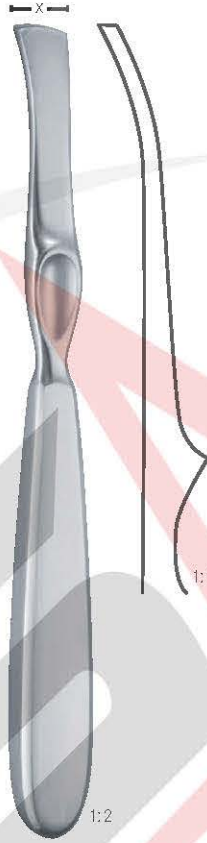

**LAMBOTTE**

	210 mm - 8 1/4"
x = 5 mm	<b>BS 14-575-01</b>
x = 10 mm	<b>BS 14-575-02</b>
x = 15 mm	<b>BS 14-575-03</b>
x = 20 mm	<b>BS 14-575-04</b>
x = 25 mm	<b>BS 14-575-05</b>

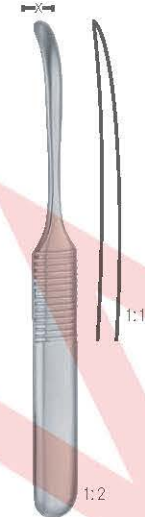

**WILLIGER**

	x = 5 mm
130 mm - 5"	<b>BS 14-585-01</b>



**ADSON**

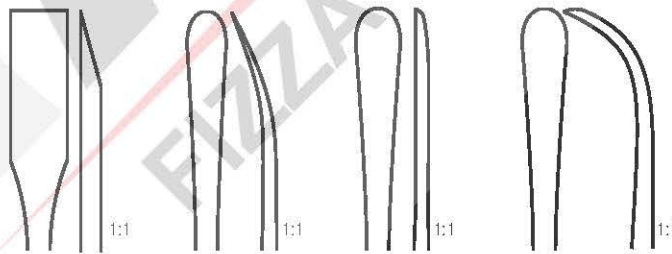

	Fig. 1	Fig. 2	Fig. 3	Fig. 4
170 mm - 6 3/4"	<b>BS 14-580-01</b>	<b>BS 14-580-02</b>	<b>BS 14-580-03</b>	<b>BS 14-580-04</b>



**WILLIGER**

	160 mm - 6 1/4"
x = 4 mm	<b>BS 14-590-01</b>
x = 6 mm	<b>BS 14-590-02</b>

Raspatorien – Elevatorien  
 Rugines – Elevateurs  
 Raspatorios – Elevadores  
 Periostotomi – Elevatori

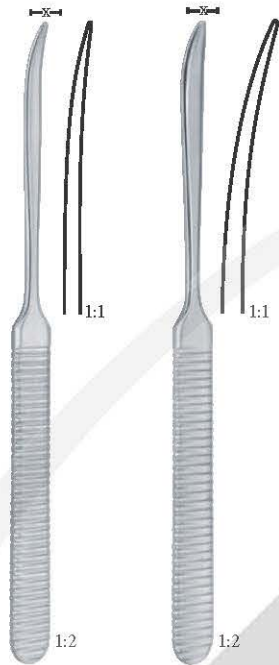

**WILLIGER**

	x = 5 mm	x = 6,5 mm
160 mm – 6 <sup>1</sup> / <sub>4</sub> "	BS 14-595-01	BS 14-596-01



**FARABEAUF-COLLIN**

	x = 11 mm	x = 11 mm
160 mm – 6 <sup>1</sup> / <sub>4</sub> "	BS 14-600-01	BS 14-601-01



**OBWEGESER**

	2.5 mm	4 mm
150 mm – 6"	BS 14-605-01	BS 14-606-01



**OBWEGESER**

	185 mm – 7 <sup>1</sup> / <sub>4</sub> "
BS 14-610-01	



**OBWEGESER**

	185 mm – 7 <sup>1</sup> / <sub>4</sub> "
BS 14-611-01	

Raspatorien – Elevatorien  
 Rugines – Elevateurs  
 Raspatorios – Elevadores  
 Periostotomi – Elevatori



<b>SEMB</b>	1:2	1:2	1:2	1:2	1:2	1:2
	175 mm – 7"	210 mm – 8 <sup>1</sup> / <sub>4</sub> "	175 mm – 7"	210 mm – 8 <sup>1</sup> / <sub>4</sub> "	225 mm – 8 <sup>3</sup> / <sub>4</sub> "	220 mm – 8 <sup>3</sup> / <sub>4</sub> "
	12 mm	12 mm	13 mm	13 mm	13 mm	15 mm
	BS 14-615-01	BS 14-615-02	BS 14-615-03	BS 14-615-04	BS 14-615-05	BS 14-615-06



**HOWARTH**

215 mm – 8<sup>1</sup>/<sub>2</sub>"

BS 14-620-01

*sharp / blunt*

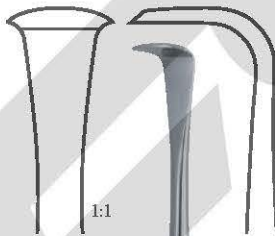

**LANGEN-BECK**

1:2

180 mm – 7"

BS 14-625-01



1:2

190 mm – 7<sup>1</sup>/<sub>2</sub>"

BS 14-630-01



**ALEXANDER**

200 mm – 8"

BS 14-635-01

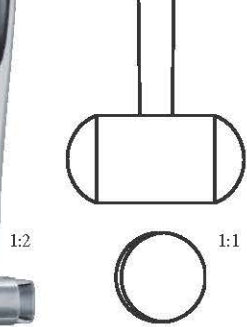

1:2

1:1

Raspatorien – Elevatorien  
Rugines – Elevateurs  
Raspatorios – Elevadores  
Periostotomi – Elevatori



**LANGENBECK**

	x = 8 mm	x = 10 mm
200 mm – 8"	<b>BS 14-640-01</b>	<b>BS 14-645-01</b>

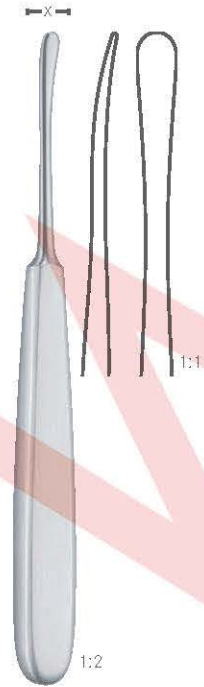
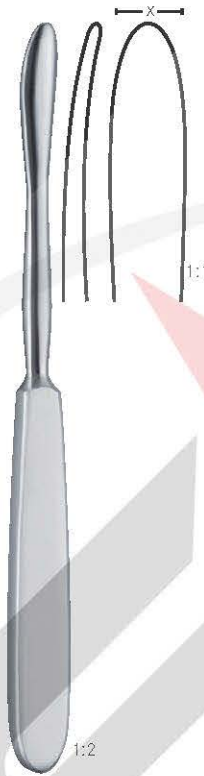

**SEBILEAU**

	x = 5 mm
175 mm – 7"	<b>BS 14-650-01</b>



175 mm – 7" **BS 14-655-01**



extrem leicht  
*extremely light*  
extrêmement léger  
*extremamente ligero*  
estremamente legera





**COBB**

	290 mm – 11 <sup>1</sup> / <sub>2</sub> "
x = 10 mm	<b>BS 14-660-01</b>
x = 13 mm	<b>BS 14-660-02</b>
x = 19 mm	<b>BS 14-660-03</b>

*Spinal raspatory*  
Rugine vertebraal

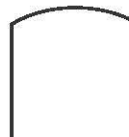
<b>KEY</b>			
	180 mm – 7"	190 mm – 7 <sup>1</sup> / <sub>2</sub> "	190 mm – 7 <sup>1</sup> / <sub>2</sub> "
	x = 6 mm	x = 10 mm	x = 12 mm
	<b>BS 14-665-01</b>	<b>BS 14-665-02</b>	<b>BS 14-665-03</b>

	
200 mm – 8"	210 mm – 8 <sup>1</sup> / <sub>4</sub> "
x = 19 mm	x = 25 mm
<b>BS 14-665-04</b>	<b>BS 14-665-05</b>

**Meniskotome**  
**Bistouries à ménisques**  
**Bisturios para meniscos**  
**Bisturi per menisco**



**BIRCHER**

190 mm – 7½" | **BS 14-670-01**

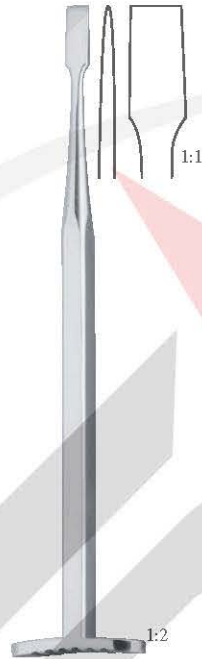

**SMILLIE**

170 mm – 6¾" | **BS 14-675-01**



**BS 14-675-02**

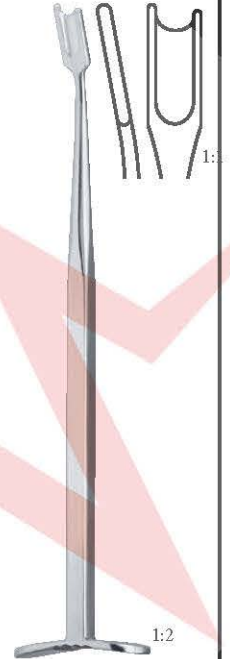

**BS 14-675-03**



**KANADISCHES  
MODELL**

Fig. 1  
**BS 14-680-01**



Fig. 2  
**BS 14-680-02**

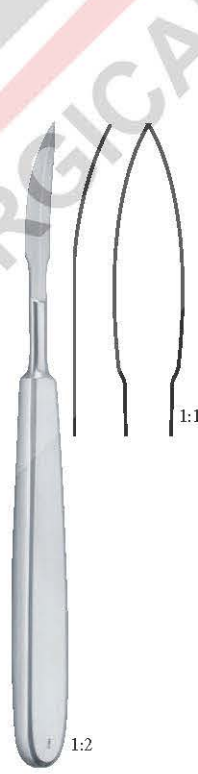

180 mm – 7" | **BS 14-680-03**



**NEFF**  
220 mm – 8¾"



**BS 14-685-01**

links  
left



**BS 14-685-02**

rechts  
right



**Sehnenstripper**  
**Instruments à écorcher les tendons**  
**Enucleadores de tendones**  
**Scollatendini**



1:1  
4.0 mm Ø  
230 mm – 9" **BS 14-690-01**

Schaft biegsam  
*Malleable shaft*

Tige malléable  
*Tija maleable*  
Asta malleabile

1:1  
4.5 mm Ø  
**BS 14-690-02**

1:1  
5.5 mm Ø  
**BS 14-690-03**



**BUNNELL** 1:1  
Fig. 1  
150 mm – 6" **BS 14-695-01**

1:1  
Fig. 2  
**BS 14-695-02**

1:1  
Fig. 3  
**BS 14-695-03**

1:1  
Fig. 4  
**BS 14-695-04**

1:1  
Fig. 5  
**BS 14-695-05**



1:1

**KLEINERT-KUTZ**  
200 mm – 8"  
20 mm Ø  
**BS 14-700-01**



1:1

**BUNNELL**  
230 mm – 9"  
**BS 14-705-01**

*Tendon passer*



1:1

**FISCHER**  
310 mm – 12 1/4"  
**BS 14-710-01**



1:2





1:2



1:2

Sehnenfasszangen  
 Pinces pour saisir les tendons  
 Pinzas para coger tendones  
 Pinze per afferrare tendini





BRAND	 1:1	 1:1	 1:1
	150 mm – 6"	190 mm – 7½"	240 mm – 9½"
	BS 14-715-01	BS 14-715-02	BS 14-715-03



130 mm – 5"  
 BS 14-720-01



 1:1	 1:1
150 mm – 6"	BS 14-725-01
	BS 14-726-01

Hohlmeißelzangen  
 Pinces gouges  
 Pinzas gubias  
 Pinze sgorbie



LUER

Fig. 1
150 mm - 6"
BS 14-730-01

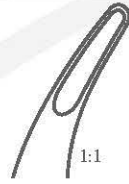

Fig. 2
BS 14-731-01



LUER

Fig. 1
170 mm - 6 <sup>3</sup> / <sub>4</sub> "
BS 14-735-01



BS 14-736-01
--------------



MINI-FRIEDMANN

120 mm - 4 <sup>3</sup> / <sub>4</sub> "
BS 14-740-01



FRIEDMANN

140 mm - 5 <sup>1</sup> / <sub>2</sub> "
BS 14-745-01



BLUMENTHAL

Fig. 1	Fig. 2
155 mm - 6"	BS 14-750-02
BS 14-750-01	

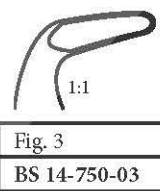
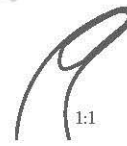
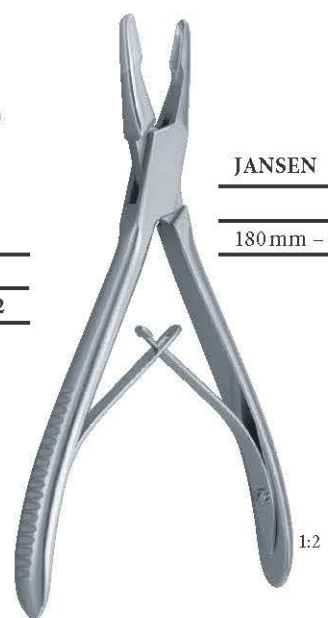

Fig. 3
BS 14-750-03



JANSEN

Fig. 1
180 mm - 7"
BS 14-755-01



Fig. 2
BS 14-755-02

Hohlmeißelzangen

Pinces gouges

Pinzas gubias

Pinze sgorbie

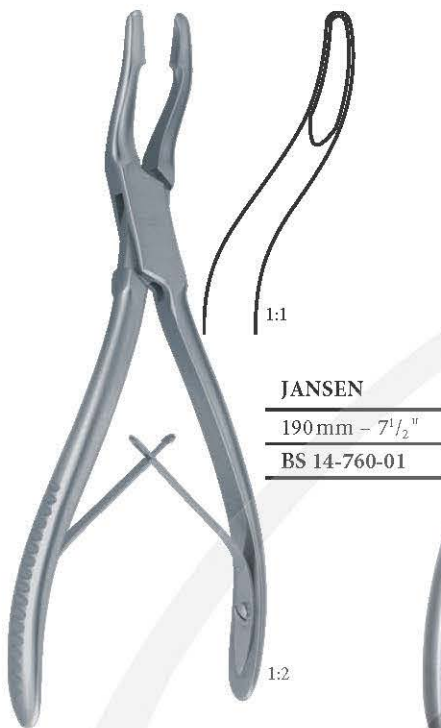

**JANSEN**

190 mm – 7<sup>1</sup>/<sub>2</sub>"  
BS 14-760-01



**ADSON**

200 mm – 8"  
BS 14-765-01



**BACON**

210 mm – 8<sup>1</sup>/<sub>4</sub>"  
BS 14-770-01



**LEMPERT**

190 mm – 7<sup>1</sup>/<sub>2</sub>" | BS 14-775-01



BS 14-776-01



**STELLBRINK**

175 mm – 7" | BS 14-780-01



leicht gebogen  
slightly curved



BS 14-781-01

stark gebogen  
strongly curved

Hohlmeißelzangen  
 Pincés gouges  
 Pinzas gubias  
 Pinze sgorbie



**OLIVECRONA**  
 205 mm - 8"  
 BS 14-785-01

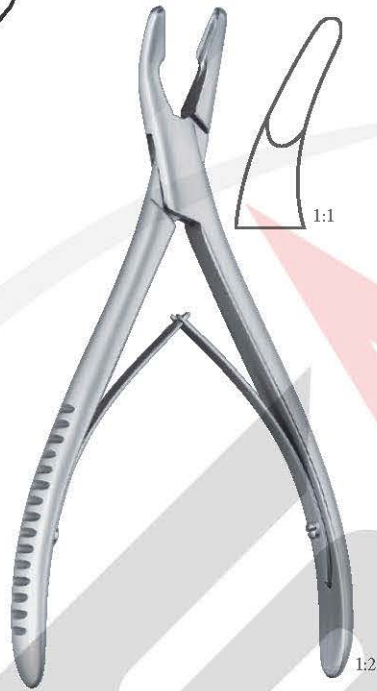

**HARTMANN**  
 175 mm - 7"  
 BS 14-790-01



**MEAD**  
 165 mm - 6 1/2"  
 BS 14-795-01



**Cleveland**  
 170 mm - 6 3/4"  
 BS 14-800-01



**CLEVELAND**  
 140 mm - 5 1/2"  
 BS 14-805-01



**BOHLER**  
 150 mm - 6"  
 BS 14-810-01



**BS 14-811-01**

**Hohlmeißelzangen**

**Pinces gouges**

**Pinzas gubias**

**Pinze sgorbie**



**BEYER**  
180 mm - 7"  
BS 14-815-01



**RUSKIN**  
180 mm - 7" BS 14-820-01

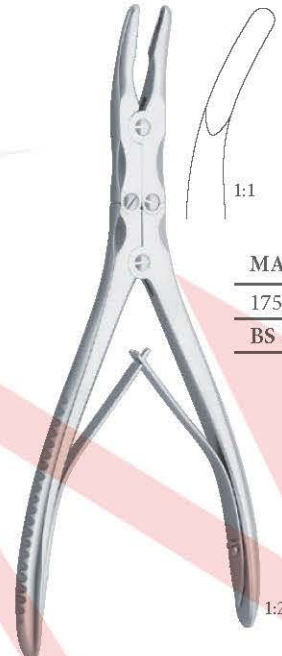
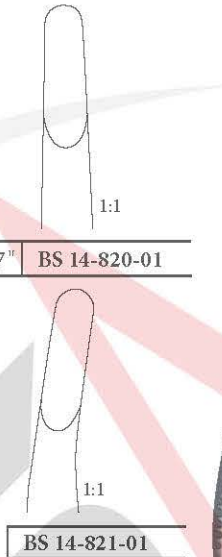

**MAYFIELD**  
175 mm - 7"  
BS 14-825-01



**ZAUFAL-JANSEN**  
180 mm - 7"  
BS 14-830-01



**MARQUARDT**  
200 mm - 8"  
BS 14-835-01

Hohlmeißelzangen  
 Pinces gouges  
 Pinzas gubias  
 Pinze sgorbie



**STILLE - RUSKIN**

230 mm - 9" **BS 14-840-01**

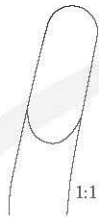

**BS 14-841-01**



**STILLE**

4 mm  
 230 mm - 9" **BS 14-845-01**



6 mm  
**BS 14-845-02**



8 mm  
**BS 14-845-03**



**LEKSELL**

4 mm  
 240 mm - 9 1/2" **BS 14-850-01**



6 mm  
**BS 14-850-02**



8 mm  
**BS 14-850-03**



**STILLE-LUER**

4 mm  
 220 mm - 8 3/4" **BS 14-855-01**

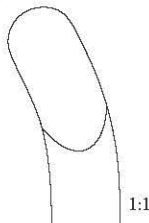
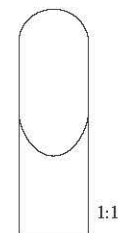

**BS 14-856-01**

Hohlmeißelzangen  
 Pincés gouges  
 Pinzas gubias  
 Pinze sgorbie



**ROTTGEN-  
RUSKIN**

230 mm – 9"

BS 14-860-01

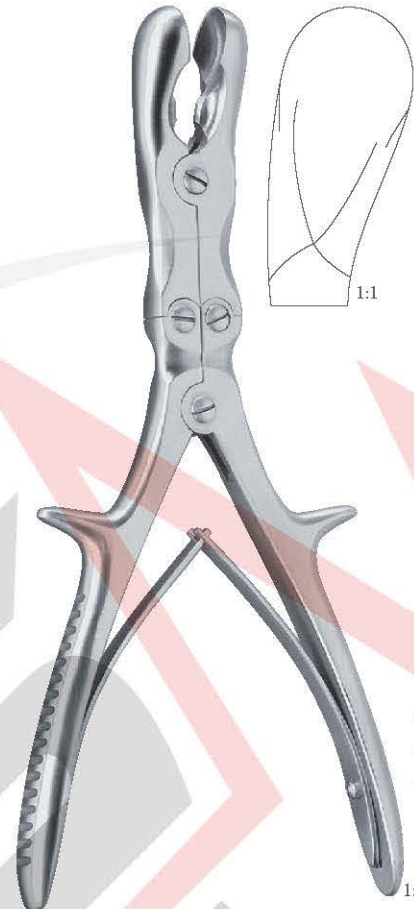

**SEMB**

240 mm – 9<sup>1</sup>/<sub>2</sub>"

BS 14-865-01



**ECHLIN**

230 mm – 9"

BS 14-870-01

BS 14-870-02



**FRYKHOLM**

240 mm – 9<sup>1</sup>/<sub>2</sub>"

BS 14-875-01



Hohlmeißelzangen  
 Pinces gouges  
 Pinzas gubias  
 Pinze sgorbie



SAUERBRUCH	Fig. 1	Fig. 2
300 mm – 12"	BS 14-880-01	BS 14-881-01

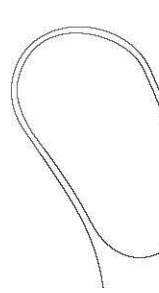
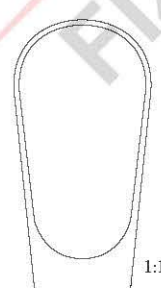

LUER- STILLE	BS 14-885-01	BS 14-886-01
270 mm – 10 <sup>3</sup> / <sub>4</sub> "		



**Knochensplitterzangen**  
**Pinces coupantes à os**  
**Pinzas cortantes para huesos**  
**Cesoie per ossa**

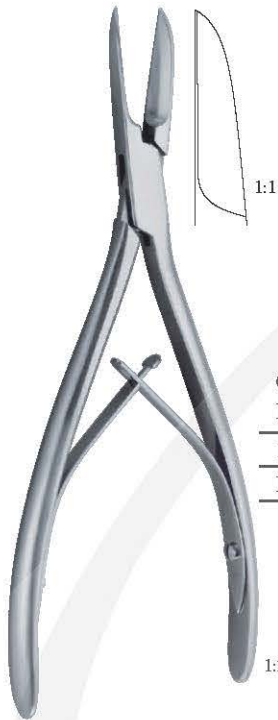

**COTTLE-  
KAZANJIAN**

190 mm – 7½"   
BS 14-890-01



**LISTON**

140 mm – 5½"	BS 14-895-01	BS 14-896-01
170 mm – 6¾"	BS 14-895-02	BS 14-896-02
190 mm – 7½"	BS 14-895-03	BS 14-896-03
220 mm – 8¾"	BS 14-895-04	BS 14-896-04

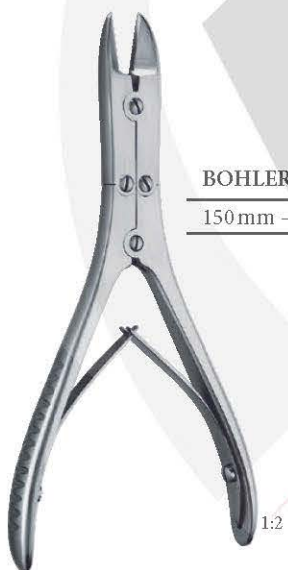

**BOHLER**

150 mm – 6" | BS 14-900-01 | BS 14-901-01



**RUSKIN- LISTON**

185 mm – 7¼" | BS 14-905-01 | BS 14-906-01

**Knochensplitterzangen**  
**Pinces coupantes à os**  
**Pinzas cortantes para huesos**  
**Cesoie per ossa**



**SEMB**

240 mm – 9<sup>1</sup>/<sub>2</sub>"

BS 14-910-01

1:2



**LISTON-KEY HORSLEY**

270 mm – 10<sup>3</sup>/<sub>4</sub>"

BS 14-915-01

1:2



1:2

**STILLE- LISTON**

270 mm – 10<sup>3</sup>/<sub>4</sub>"

BS 14-920-01

**1:1**

BS 14-921-01

**1:1**

BS 14-922-01

**Knochenhalte­zangen – Repositionszangen**  
**Daviers porte-os – Pinces de reposition**  
**Pinzas para huesos – Pinzas para reposición**  
**Tenaglie per ossa – Pinze per riposizioni**



135 mm – 5<sup>1</sup>/<sub>4</sub>"  
BS 14-925-01



LEWIN  
175 mm – 7"  
BS 14-930-01

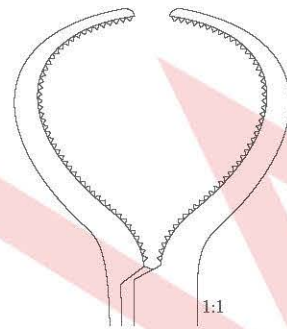

1:1



140 mm – 5<sup>1</sup>/<sub>2</sub>"  
BS 14-935-01



1:1

1:2

**BONE SURGERY - Bone Holding Clamps - Bone Holding Forceps**

**Knochenhalteklammern - Knochenhaltezangen**

**Daviers à os - Daviers porte-os**

**Pinzas porta huesos - Pinzas para huesos**

**Tenaglie per ossa**



**FERGUSSON**

210 mm - 8<sup>1</sup>/<sub>4</sub>"

BS 14-940-01



**VAN BUREN**

230 mm - 9"

BS 14-945-01

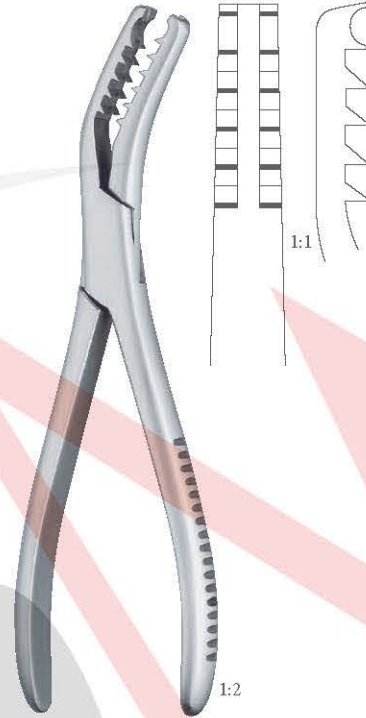

**SEMB**

190 mm - 7<sup>1</sup>/<sub>2</sub>"

BS 14-950-01



**LANGENBECK**

210 mm - 8<sup>1</sup>/<sub>4</sub>"

BS 14-955-01



**DINGMANN**

190 mm - 7<sup>1</sup>/<sub>2</sub>"

BS 14-960-01

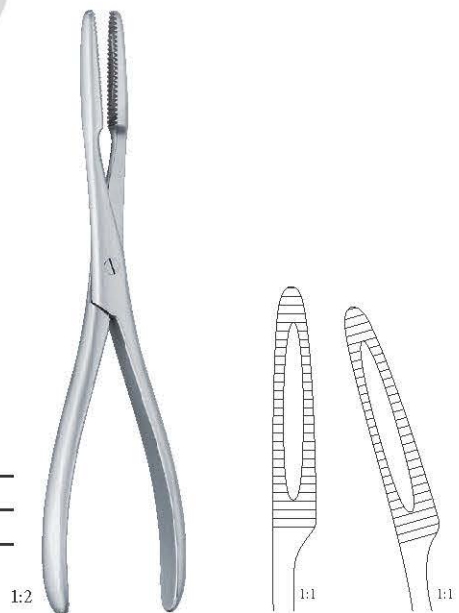

200 mm - 8"

BS 14-965-01

BS 14-966-01

**Sequesterzange**  
**Sequestrum forceps**

**Knochenhalte­zangen**  
**Daviers porte-os**  
**Pinzas para huesos**  
**Tenaglie per ossa**



**FARABEUF**

230 mm – 9"	BS 14-970-01
260 mm – 10 <sup>1</sup> / <sub>4</sub> "	BS 14-970-02



**FARABEUF - LAMBOTTE**

260 mm – 10 <sup>1</sup> / <sub>4</sub> "	BS 14-975-01
---	--------------

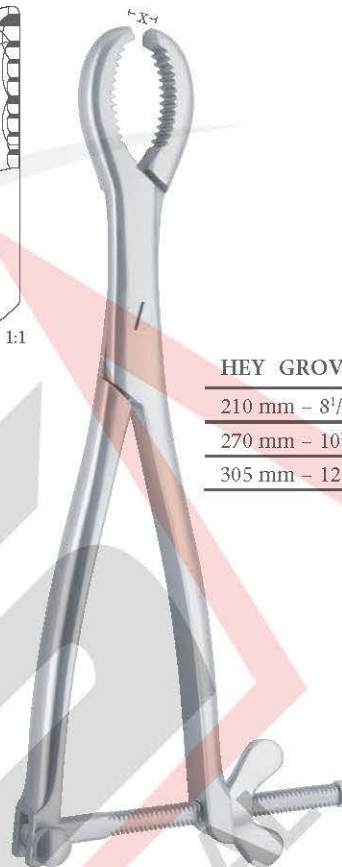

**HEY GROVES**

210 mm – 8 <sup>1</sup> / <sub>4</sub> "	x = 6.5 mm	BS 14-980-01
270 mm – 10 <sup>3</sup> / <sub>4</sub> "	x = 7.5 mm	BS 14-980-02
305 mm – 12"	x = 8.5 mm	BS 14-980-03

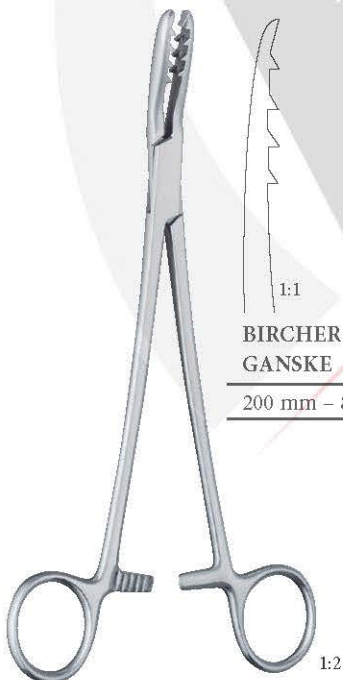

**BIRCHER - GANSKE**

200 mm – 8"	BS 14-985-01	BS 14-986-01
-------------	--------------	--------------



**MARTIN**

190 mm – 7 <sup>1</sup> / <sub>2</sub> "	BS 14-990-01
--	--------------

**Knochenhaltezangen**  
**Daviers porte-os**  
**Pinzas para huesos**  
**Tenaglie per ossa**

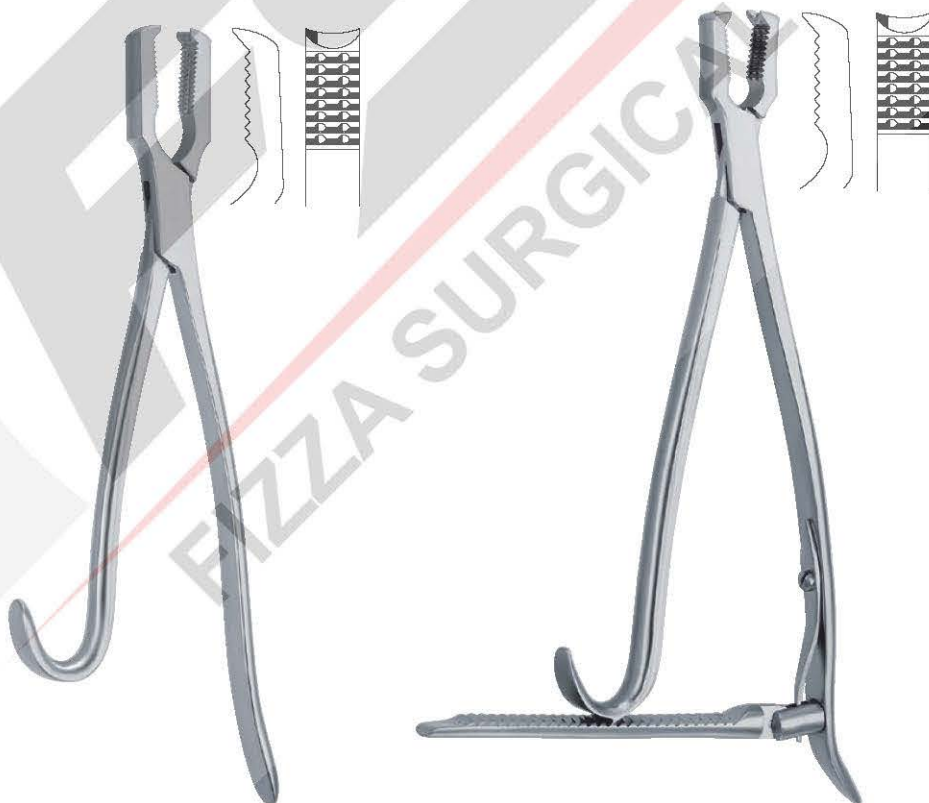
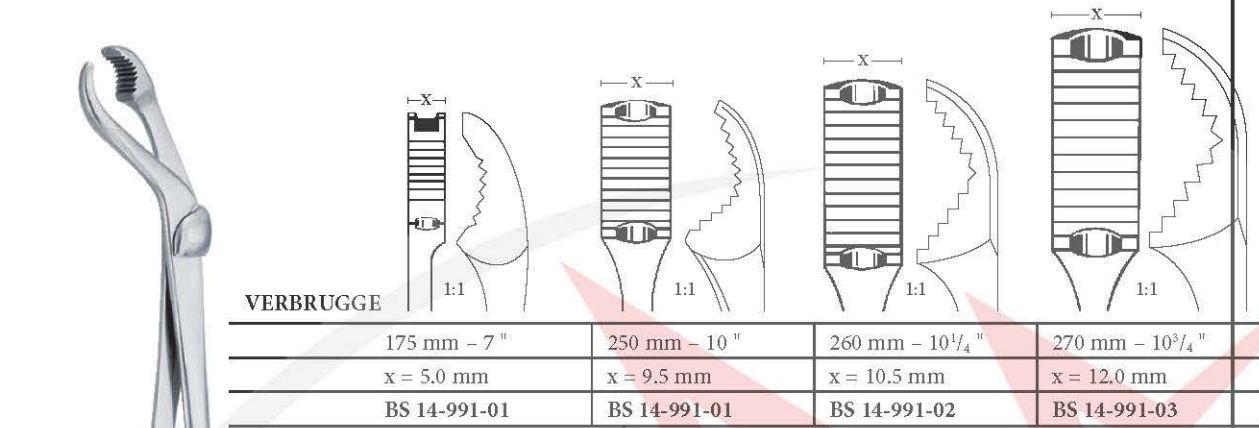

**KERN**

170 mm – 6 <sup>3</sup> / <sub>4</sub> "	BS 14-992-01	BS 14-993-01
210 mm – 8 <sup>1</sup> / <sub>4</sub> "	BS 14-992-02	BS 14-993-02

**Knochenhaltezangen**  
**Daviers porte-os**  
**Pinzas para huesos**  
**Tenaglie per ossa**

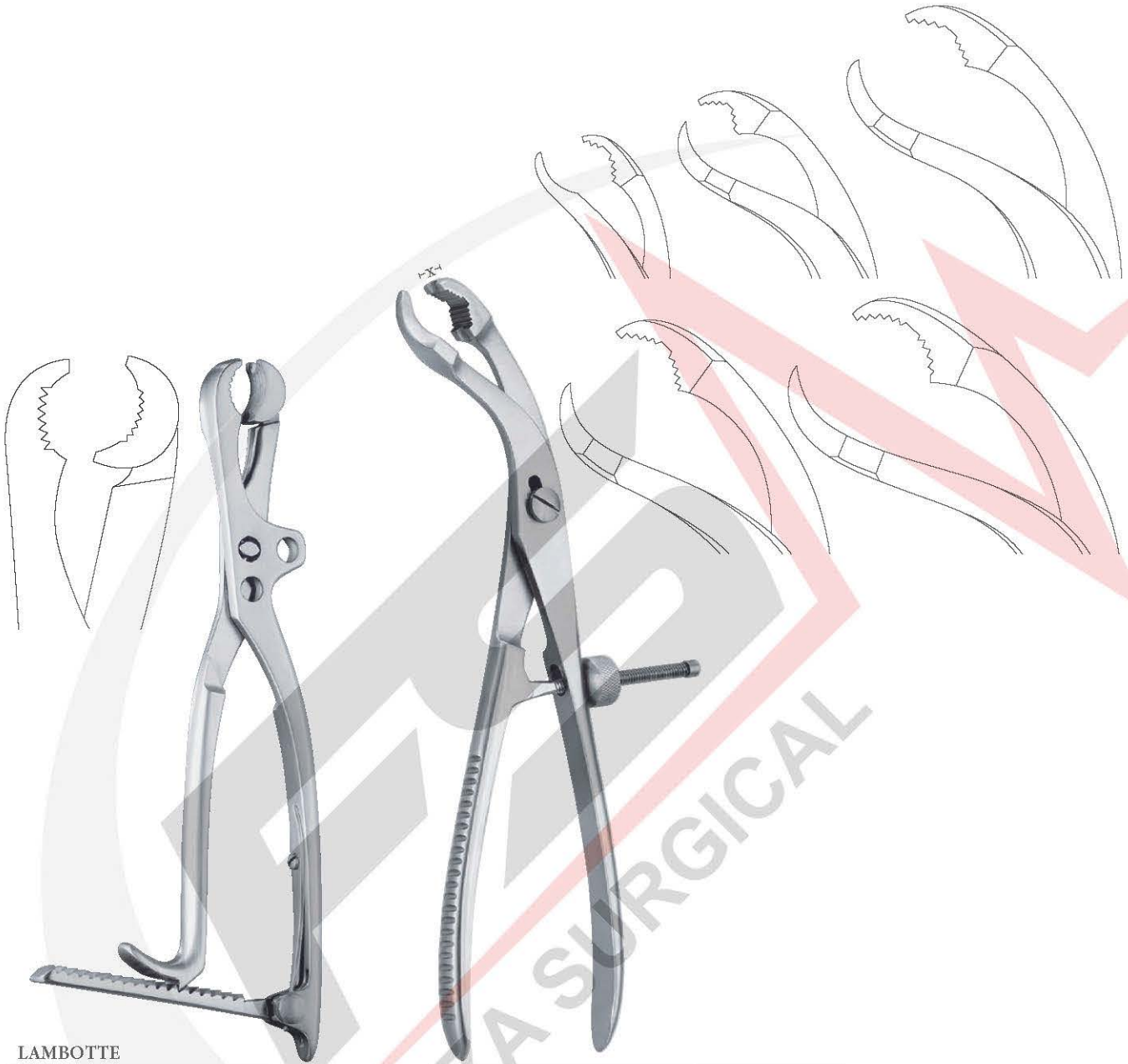

**LAMBOTTE**

220 mm - 8 <sup>3</sup> / <sub>4</sub> "	BS 14-994-01
270 mm - 10 <sup>3</sup> / <sub>4</sub> "	BS 14-994-02
300 mm - 12 "	BS 14-994-03

*One Jaw Mobile*

150 mm - 6 "	x = 2.5 mm	BS 14-995-01
190 mm - 7 <sup>1</sup> / <sub>2</sub> "	x = 6.5 mm	BS 14-995-02
240 mm - 9 <sup>1</sup> / <sub>2</sub> "	x = 9.5 mm	BS 14-995-03
260 mm - 10 <sup>1</sup> / <sub>4</sub> "	x = 10.0 mm	BS 14-995-04
280 mm - 11 "	x = 11.0 mm	BS 14-995-05

*Self-Centering*



Knochenhalte­zangen  
Daviers porte-os  
Pinzas para huesos  
Tenaglie per ossa



LANE

330 mm - 13"	BS 14-996-01	BS 14-997-01
450 mm - 17 <sup>3</sup> / <sub>4</sub> "	BS 14-996-02	BS 14-997-02

**Knochenhaltezaugen**  
**Daviers porte-os**  
**Pinzas para huesos**  
**Tenaglie per ossa**

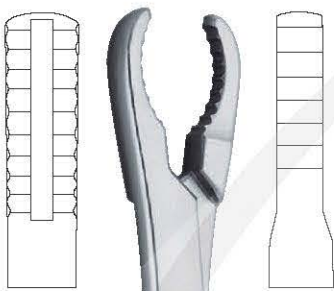

**ULRICH**

230 mm – 9"	BS 14-998-01	BS 14-999-01
250 mm – 9 <sup>3</sup> / <sub>4</sub> "	BS 14-998-02	BS 14-999-02
280 mm – 11"	BS 14-998-03	BS 14-999-03

*Angular*

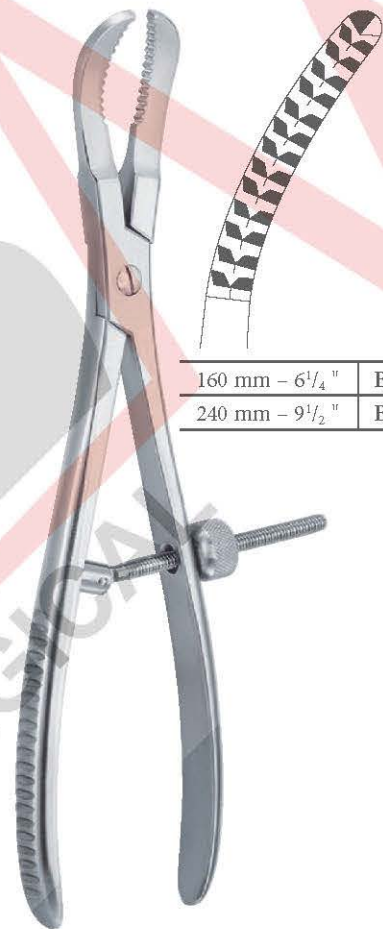

160 mm – 6 <sup>1</sup> / <sub>4</sub> "	BS 14-1000-01
240 mm – 9 <sup>1</sup> / <sub>2</sub> "	BS 14-1000-02

**Knochenhaltezangen – Repositionszangen**  
**Daviers porte-os – Pinces de reposition**  
**Pinzas para huesos – Pinzas para reposición**  
**Tenaglie per ossa – Pinze per riposizione**



135 mm – 5¼"  
BS 14-1005-01



REILL  
170 mm – 6¾"  
BS 14-1006-01

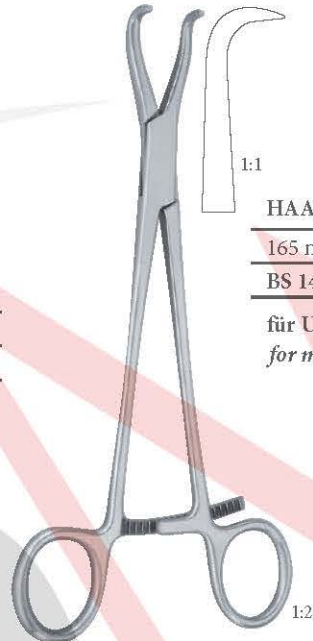

HAASE  
165 mm – 6½"  
BS 14-1007-01  
für Unterkieferfrakturen  
for mandibular fractures



200 mm – 8"  
BS 14-1008-01

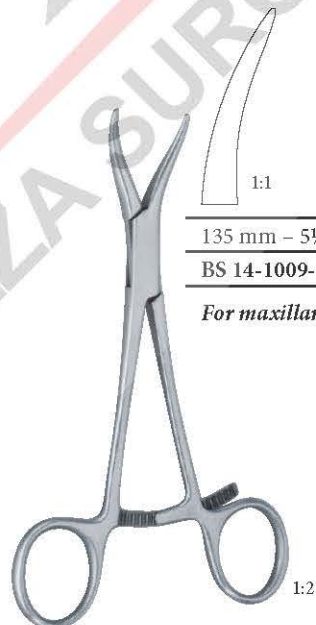

135 mm – 5¼"  
BS 14-1009-01  
For maxillary

Repositionszangen  
 Pinces de  
 reposition Pinzas  
 para reposición  
 Pinze per  
 riposizione

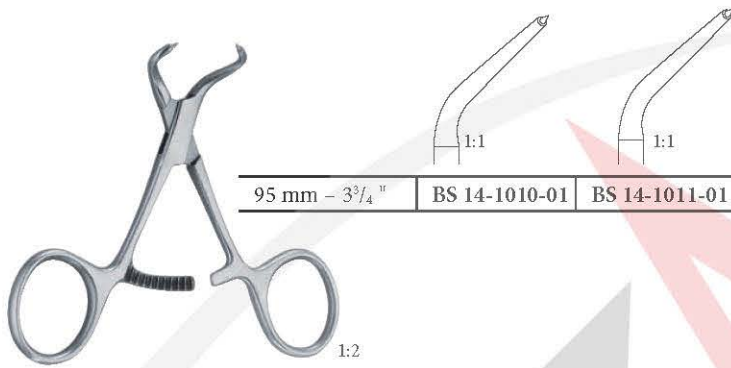

**Draht-Instrumentarium**  
**Instruments pour cerclage**  
**Instrumental para cerclaje**  
**Strumenti per filo di cerchiaggio**



DEMEL 1:2

	280 mm - 11"
x = 32 mm	BS 14-1014-01
x = 45 mm	BS 14-1014-02
x = 62 mm	BS 14-1014-03



DEMEL 1:2

	280 mm - 11"
	BS 14-1015-01

Drahtschneidezangen  
 Pinces coupantes  
 Alicates para cortar alambre  
 Pinze taglia filo



220 mm - 8<sup>3</sup>/<sub>4</sub>"

BS 14-1020-01

For hard wires up to 2.2 mm Ø, for soft wires up to 2.8 mm Ø



230 mm - 9"

BS 14-1025-01

For hard wires up to 2.2 mm Ø, for soft wires up to 3 mm Ø

**Drahtschneidezangen**  
**Pinces coupantes**  
**Alicates para cortar alambre**  
**Pinze taglia filo**



180 mm – 7"	BS 14-1030-01
-------------	---------------

*For soft wires up to 2 mm Ø*



180 mm – 7"	BS 14-1035-01
-------------	---------------

*For hard wires up to 1.7 mm Ø, for soft wires up to 2 mm Ø*



150 mm – 6"	BS 14-1040-01
-------------	---------------

*For hard wires up to 1 mm Ø, For soft wires up to 1.5 mm Ø*



185 cm – 7 <sup>1</sup> / <sub>4</sub> "	BS 14-1050-01
--	---------------

*Wire cutting forceps for hard wires up to 1.6 mm Ø*



145 mm – 5 <sup>3</sup> / <sub>4</sub> "	BS 14-1045-01
--	---------------

*For hard wires up to 1 mm Ø*

Drahtschneidezangen  
Pincés coupantes  
Alicates para cortar alambre  
Pinze taglia filo



570 mm – 22 $\frac{1}{2}$ " | BS 14-1055-01

*For Kirschner wires and Steinmann pins up to 6 mm Ø*

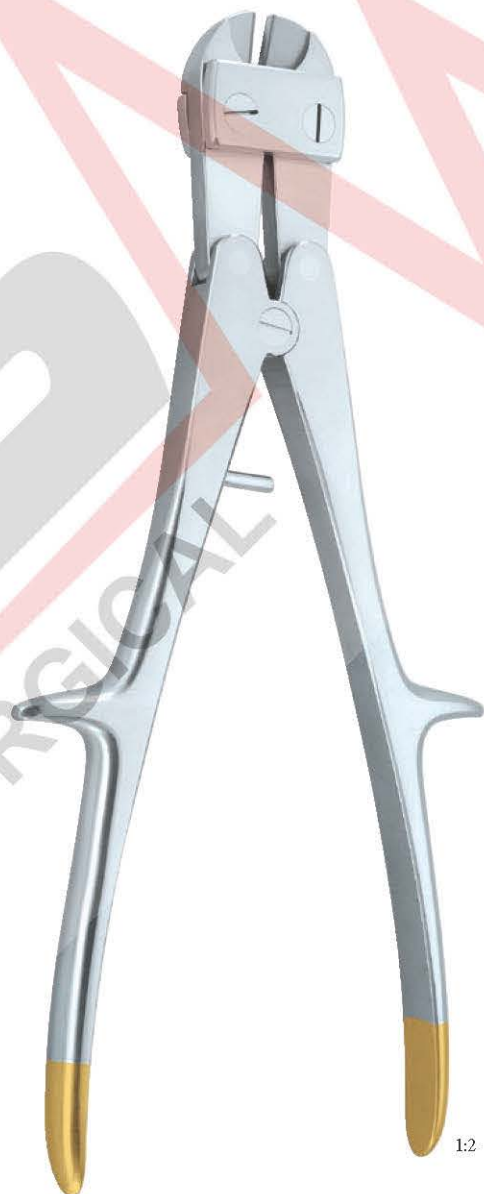

260 mm – 10 $\frac{1}{4}$ " | BS 14-1060-01

*For hard wires up to 3 mm Ø*



**Technische Zangen  
Pinces techniques  
Pinzas tecnicas  
Pinze tecniche**



130 mm – 5"	BS 14-1065-01
180 mm – 7"	BS 14-1065-02



140 mm – 5 1/2"	BS 14-1070-01
170 mm – 6 3/4"	BS 14-1070-02



	180 mm – 7"	180 mm – 7"
x = 5 mm	BS 14-1075-01	BS 14-1076-01
x = 7 mm	BS 14-1075-02	BS 14-1076-02

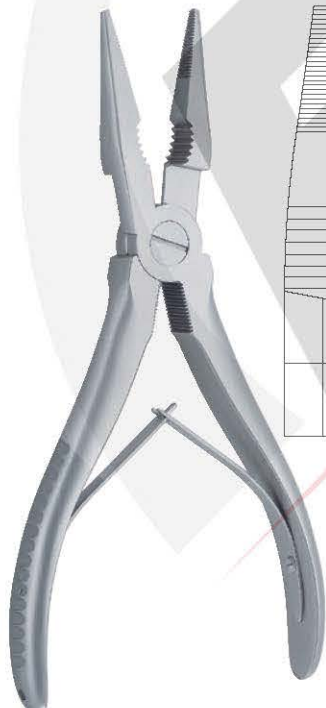

170 mm – 6 3/4"	BS 14-1080-01
-----------------	---------------



220 mm – 8 3/4"	BS 14-1085-01
-----------------	---------------

Grip-Zange, kombiniert mit TC-Schneider Grip forceps, combined with



190 mm – 7 1/2"	BS 14-1090-01
-----------------	---------------

Technische Zange, verstellbar  
Technical forceps, adjustable

Technische Zangen  
 Pinces techniques  
 Pinzas tecnicas  
 Pinze tecniche



185 mm – 7 <sup>1</sup> / <sub>4</sub> "	BS 14-1095-01
--	---------------

*Wire bending forceps*



185 mm – 7 <sup>1</sup> / <sub>4</sub> "	BS 14-1100-01
--	---------------

*Flat nose plier, parallel grip, incorporated cutter, for hard wires up to 1.6mm Ø*



180 mm – 7"	BS 14-1105-01
200 mm – 8"	BS 14-1105-02
240 mm – 9 <sup>1</sup> / <sub>2</sub> "	BS 14-1105-03

*Locking plier*

Technische Zangen  
 Pinces techniques  
 Pinzas tecnicas  
 Pinze tecniche

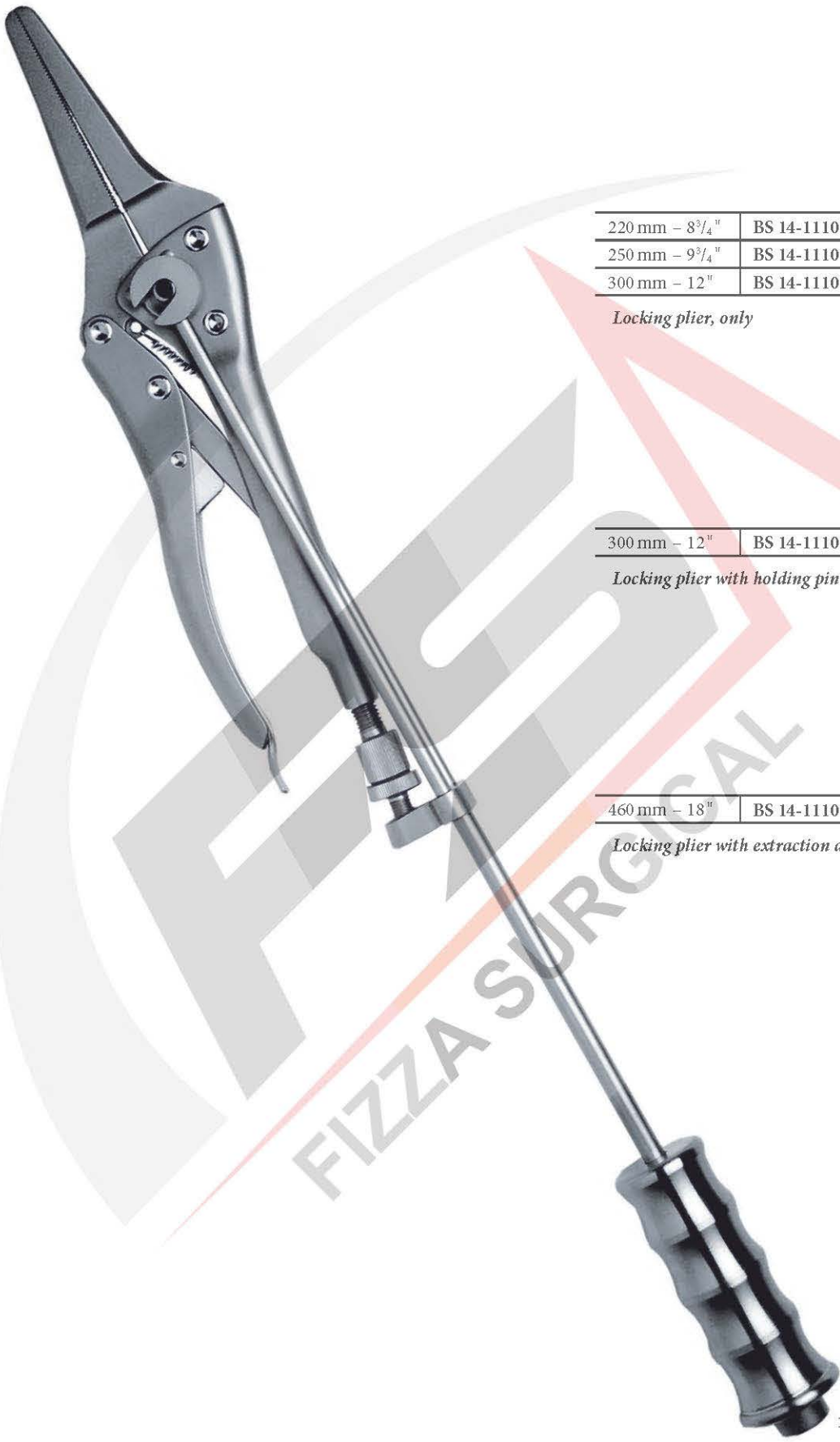

220 mm – 8 <sup>3</sup> / <sub>4</sub> "	BS 14-1110-01
250 mm – 9 <sup>3</sup> / <sub>4</sub> "	BS 14-1110-02
300 mm – 12"	BS 14-1110-03

*Locking plier, only*

300 mm – 12"	BS 14-1110-04
--------------	---------------

*Locking plier with holding pins*

460 mm – 18"	BS 14-1110-05
--------------	---------------

*Locking plier with extraction device*

1:2

Technische Zangen  
Pincés técnicas  
Pinzas técnicas  
Pinze tecniche



200 mm - 8"	BS 14-1115-01
-------------	---------------

*Plate bending plier for plates up to 2.7 mm*

240 mm - 9 1/2"	BS 14-1115-02
-----------------	---------------

*Plate bending plier for plates up to 4 mm*

Spiralbohrer – Pfrieme  
 Mêches – Alênes  
 Taladros espirales – Escariadores  
 Punte a spirale – Perforatori a mano

