

# *PINZETTEN – FORCEPS*

*By*

Fizza Surgical International



## COMPANY PROFILE

Company name : FIZZA SURGICAL INTERNATIONAL

Company address : NARGATE STREET, JINNAH PARK , COLONY #2,,  
Sialkot – 51310 Pakistan

PHONE : +92-52-460 4164

FAX : +92-52-458 0014

E-MAIL : info@fizzasurgical.com

Web site : www.fizzasurgical.com

LEGAL STATUS OF COMPANY : Partnership

PERSON TO CONTACT : NAJAF ALI  
DESIGNATION : Partner  
info@fizzasurgical.com

PERSON TO CONTACT : NAJAM ALI  
DESIGNATION : Partner  
Najam.Ali@fizzasurgical.com

PERSON TO CONTACT : ALI HASSAN  
DESIGNATION : Partner  
Ali.Hassan@fizzasurgical.com

Products manufacture: GYNECOLOGY INSTRUMENTS, ALL TYPE OF SCISSORS,  
RFORCEPS AND ETRACTORS etc.

O.E.M. We can produce any type of vaginal speculums, retractors, dilators  
Forceps, Scissors etc.  
Also on O.E.M. basis if the drawings or Master samples are  
provided To us by the customer.

Areas of Exports : Germany, France, Japan, U.K. etc.

CERTIFICATION : ISO 9001 : 2008  
ISO 13485 : 2003  
CE CERTIFICATION BY MHRA – UK  
EC DECLARATION OF CONFORMITY

QUALITY POLICY : CUSTOMER'S SATISFACTION

MISSION STATEMENT : TO BECOME TOP MOST MEDICAL COMPANY IN PAKISTAN

Brief History of the company: Fizza Surgical International has made revolutionary changes in its manufacturing procedures from hand-made to modern machinery during the last 3 decades. Highly skilled workers are Proficiently working on these machinery multiplying production figures on one hand and having improved the quality of products to entire satisfaction of the customers.

Materials used in production : The materials used in production of these medical instruments conform to internationally recognized standards; viz. Grade AISI-410, Grade AISI-420 and Grade AISI-304. We use Japanese, German and French stainless steels.

**PINZETTEN – FORCEPS - Anatomische Pinzetten - Dressing forceps**

Pinces à dissection  
 Pinzas de disección  
 Pinze anatomiche



**Standard**

105mm – 4 <sup>1</sup> / <sub>4</sub> "	DF 03-10-01	DF 03-15-01	DF 03-20-01
115mm – 4 <sup>1</sup> / <sub>2</sub> "	DF 03-10-02	DF 03-15-02	DF 03-20-02
130mm – 5"	DF 03-10-03	DF 03-15-03	DF 03-20-03
145mm – 5 <sup>3</sup> / <sub>4</sub> "	DF 03-10-04	DF 03-15-04	DF 03-20-04
150mm – 6"	DF 03-10-05	DF 03-15-05	DF 03-20-05
160mm – 6 <sup>1</sup> / <sub>4</sub> "	DF 03-10-06	DF 03-15-06	DF 03-20-06
180mm – 7"	DF 03-10-07	DF 03-15-07	DF 03-20-07
200mm – 8"	DF 03-10-08	DF 03-15-08	DF 03-20-08
250mm – 10"	DF 03-10-09	DF 03-15-09	DF 03-20-09
300mm – 12"	DF 03-10-10	DF 03-15-10	DF 03-20-10
350mm – 14"	DF 03-10-11	DF 03-15-11	DF 03-20-11

*Narrow*

**PINZETTEN – FORCEPS - Anatomische Pinzetten - Dressing forceps**

Pinces à dissection  
Pinzas de disección  
Pinze anatomiche



130 mm – 5"	DF 03-25-01
145 mm – 5 <sup>3</sup> / <sub>4</sub> "	DF 03-25-02
160 mm – 6 <sup>1</sup> / <sub>4</sub> "	DF 03-25-03

**crossserated**



**Stille**

150 mm – 6"	DF 03-40-01
180 mm – 7"	DF 03-40-02
200 mm – 8"	DF 03-40-03

**Mod. USA**

120 mm – 4 <sup>3</sup> / <sub>4</sub> "	DF 03-30-01	DF 03-35-01
130 mm – 5"	DF 03-30-02	DF 03-35-02
145 mm – 5 <sup>3</sup> / <sub>4</sub> "	DF 03-30-03	DF 03-35-03
155 mm – 6"	DF 03-30-04	DF 03-35-04
180 mm – 7"	DF 03-30-05	DF 03-35-05
210 mm – 8 <sup>1</sup> / <sub>4</sub> "	DF 03-30-06	DF 03-35-06
250 mm – 9 <sup>3</sup> / <sub>4</sub> "	DF 03-30-07	DF 03-35-07
310 mm – 12 <sup>1</sup> / <sub>4</sub> "	DF 03-30-08	DF 03-35-08

**narrow**



**Semken**

125 mm – 5"	DF 03-45-01
150 mm – 6"	DF 03-45-02



1:2



1:2



1:2

**Taylor**

175 mm – 7"	DF 03-50-01	DF 03-51-01	DF 03-52-01
-------------	-------------	-------------	-------------

**PINZETTEN – FORCEPS - Anatomische Pinzetten - Dressing forceps**

Pinces à dissection  
Pinzas de disección  
Pinze anatomiche

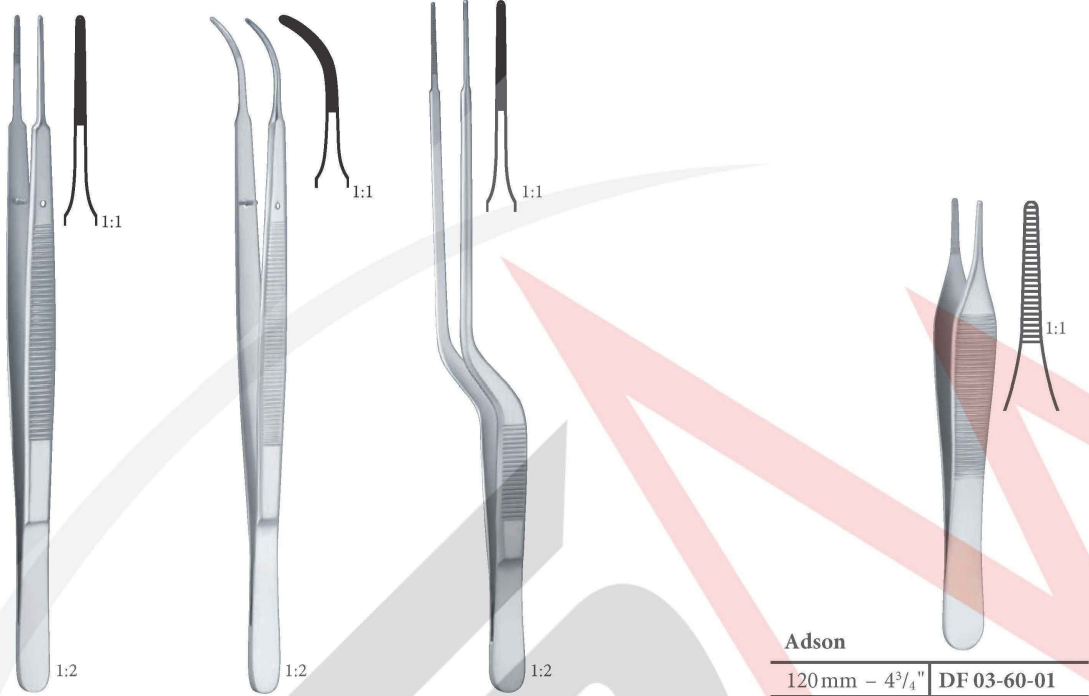

**Gerald**

180 mm – 7"	DF 03-55-01	DF 03-56-01	DF 03-57-01
-------------	-------------	-------------	-------------

**Adson**

120 mm – 4 <sup>3</sup> / <sub>4</sub> "	DF 03-60-01
150 mm – 6"	DF 03-60-02

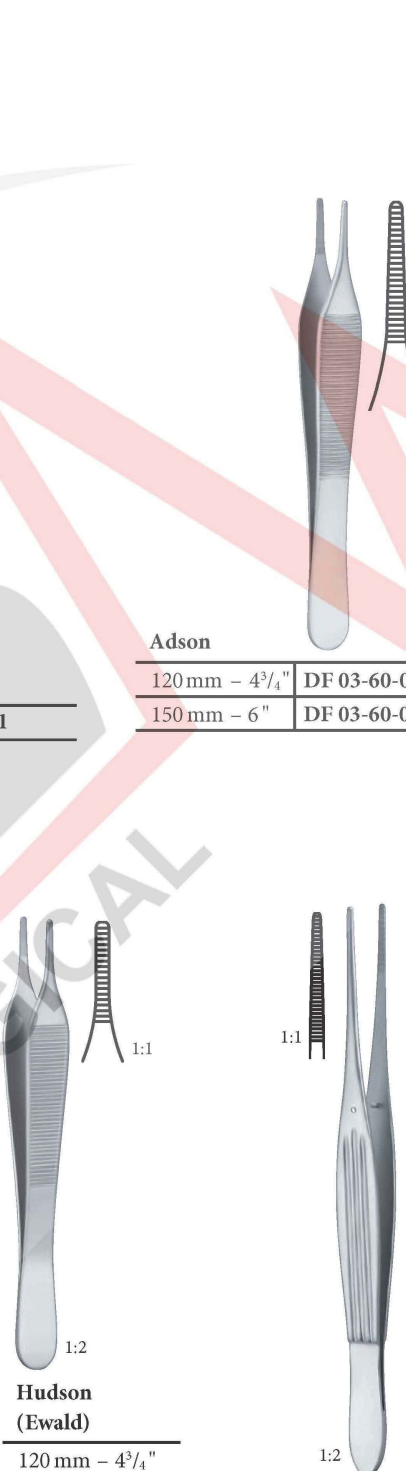

**Micro-Adson**

120 mm – 4 <sup>3</sup> / <sub>4</sub> "	DF 03-65-01
150 mm – 6"	DF 03-65-02

**Adson**

120 mm – 4 <sup>3</sup> / <sub>4</sub> "	DF 03-70-01
--	-------------

cross serrated

**Hudson (Ewald)**

120 mm – 4 <sup>3</sup> / <sub>4</sub> "	DF 03-75-01
--	-------------

**Mc Indoe**

150 mm – 6"	DF 03-85-01
-------------	-------------

**PINZETTEN – FORCEPS - Anatomische Pinzetten - Dressing Forceps**

Pinces à dissection  
Pinzas de disección  
Pinze anatomiche

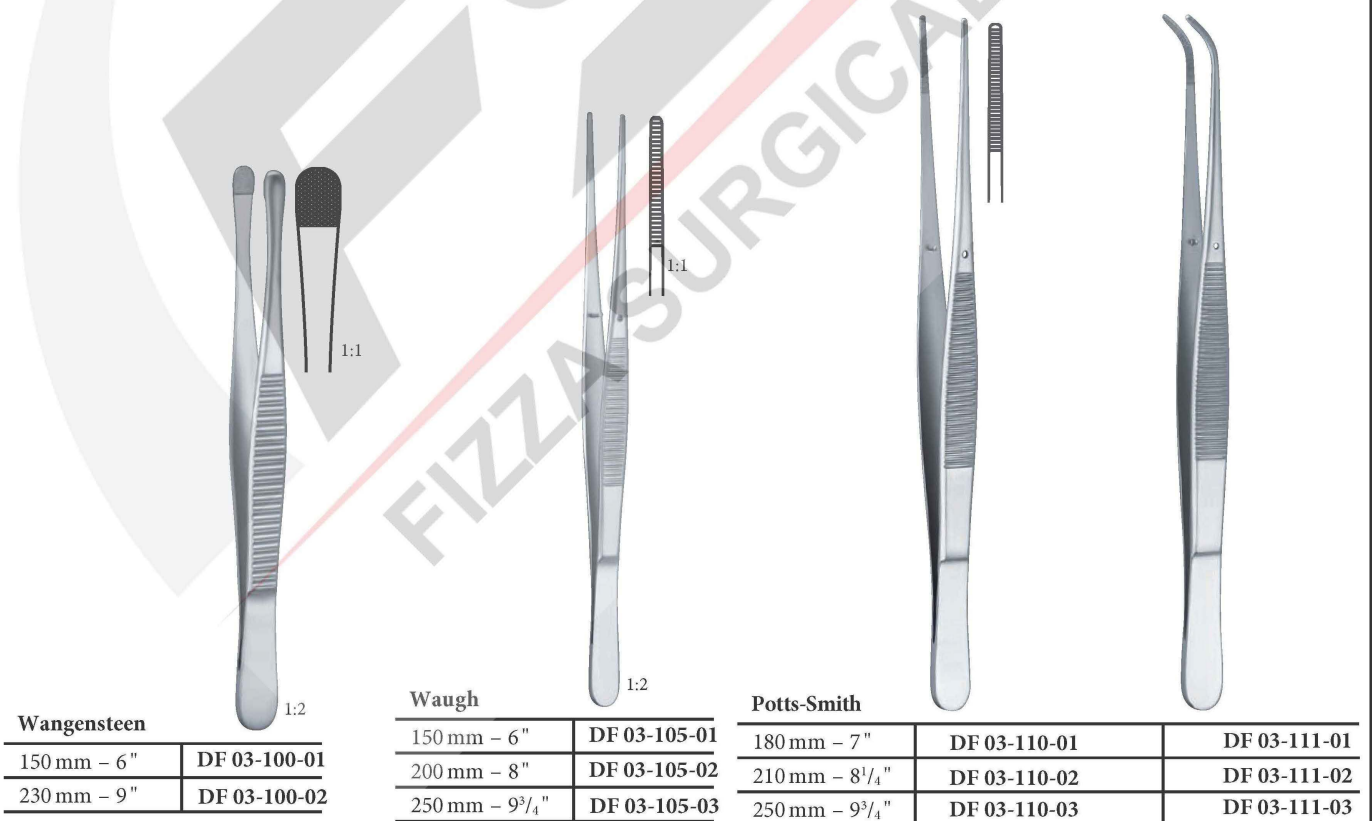

**PINZETTEN – FORCEPS - Chirurgische Pinzetten - Tissue Forceps**

Pinces à dissection à griffes  
 Pinzas de disección con dientes  
 Pinze chirurgiche

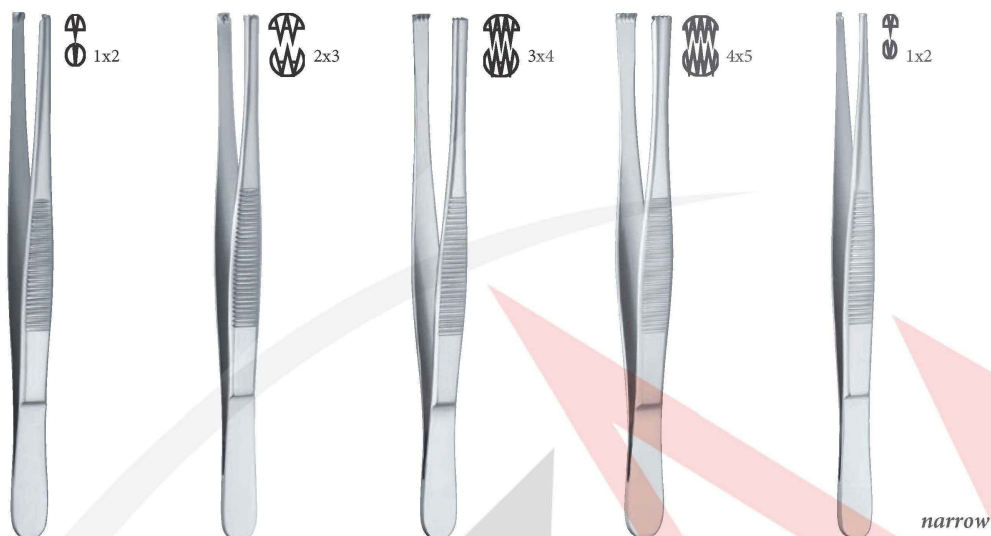

Standard					narrow
105 mm – 4 1/4"	DF 03-115-01	DF 03-116-01	DF 03-117-01	DF 03-118-01	DF 03-119-01
115 mm – 4 1/2"	DF 03-115-02	DF 03-116-02	DF 03-117-02	DF 03-118-02	DF 03-119-02
130 mm – 5"	DF 03-115-03	DF 03-116-03	DF 03-117-03	DF 03-118-03	DF 03-119-03
145 mm – 5 3/4"	DF 03-115-04	DF 03-116-04	DF 03-117-04	DF 03-118-04	DF 03-119-04
150 mm – 6"	DF 03-115-05	DF 03-116-05	DF 03-117-05	DF 03-118-05	DF 03-119-05
160 mm – 6 1/4"	DF 03-115-06	DF 03-116-06	DF 03-117-06	DF 03-118-06	DF 03-119-06
180 mm – 7"	DF 03-115-07	DF 03-116-07	DF 03-117-07	DF 03-118-07	DF 03-119-07
200 mm – 8"	DF 03-115-08	DF 03-116-08	DF 03-117-08	DF 03-118-08	DF 03-119-08
250 mm – 9 3/4"	DF 03-115-09	DF 03-116-09	DF 03-117-09	DF 03-118-09	DF 03-119-09
300 mm – 12"	DF 03-115-10	DF 03-116-10	DF 03-117-10	DF 03-118-10	DF 03-119-10
350 mm – 14"	DF 03-115-11	DF 03-116-11	DF 03-117-11	DF 03-118-11	DF 03-119-11

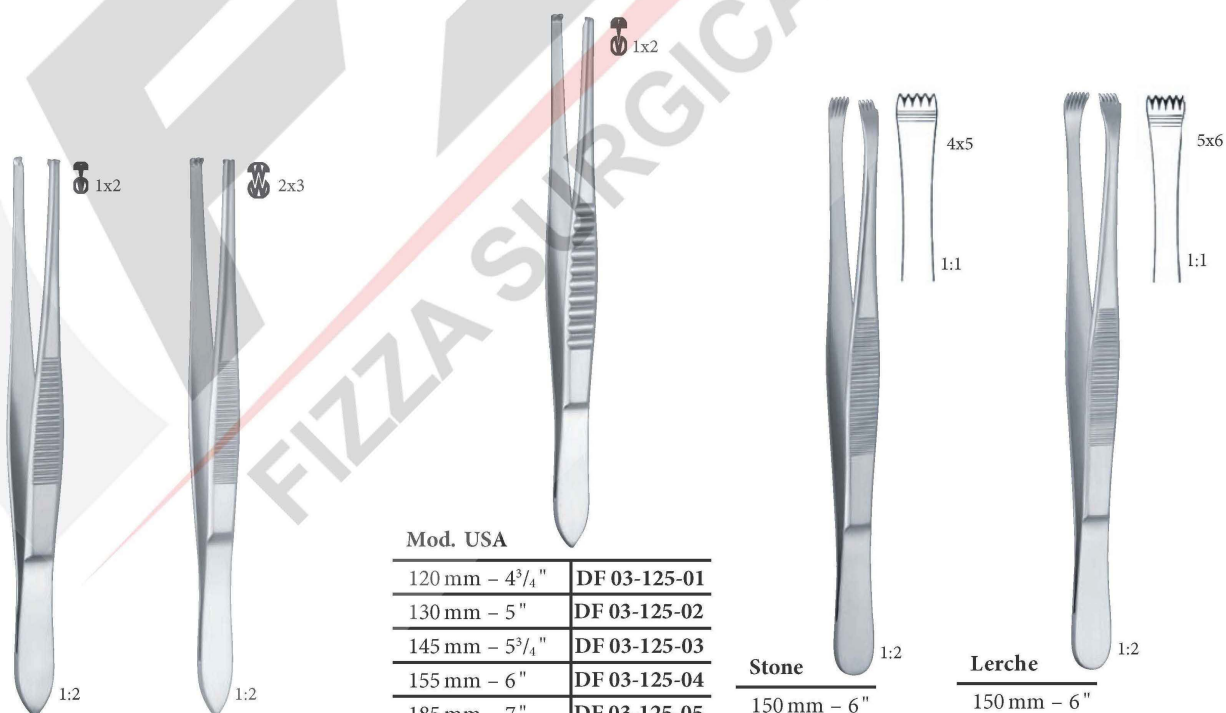

Stille		
150 mm – 6"	DF 03-120-01	DF 03-121-01

Mod. USA	
120 mm – 4 3/4"	DF 03-125-01
130 mm – 5"	DF 03-125-02
145 mm – 5 3/4"	DF 03-125-03
155 mm – 6"	DF 03-125-04
185 mm – 7"	DF 03-125-05
210 mm – 8"	DF 03-125-06
250 mm – 9 3/4"	DF 03-125-07
310 mm – 12 1/4"	DF 03-125-08

Stone	
150 mm – 6"	DF 03-130-01

Lerche	
150 mm – 6"	DF 03-135-01



**PINZETTEN – FORCEPS - Chirurgische Pinzetten - Tissue Forceps**

Pinces à dissection à griffes  
 Pinzas de disección con dientes  
 Pinze chirurgiche

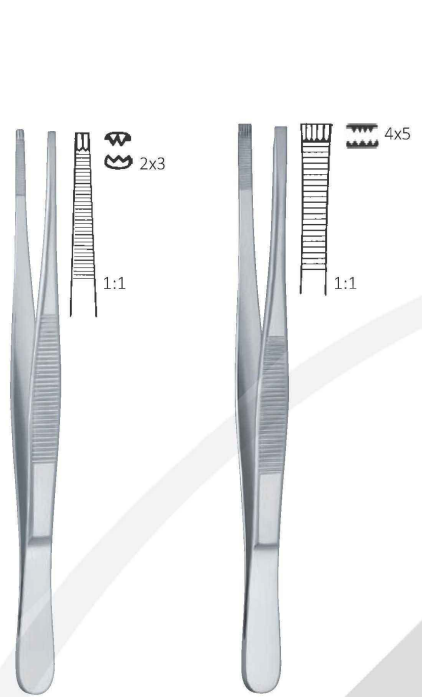

**Adlrkreutz**

150 mm – 6"	DF 03-140-01	DF 03-141-01
200 mm – 8"	DF 03-140-02	DF 03-141-02
250 mm – 9 <sup>3</sup> / <sub>4</sub> "	DF 03-140-03	DF 03-141-03

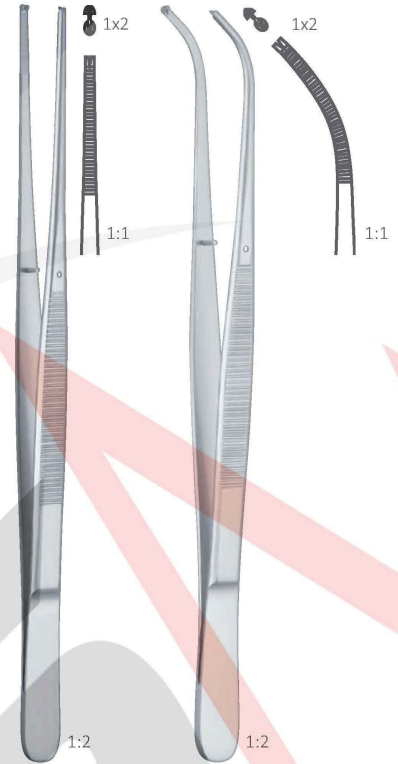

**Brophy**

200 mm – 8"	DF 03-145-01	DF 03-146-01
-------------	--------------	--------------

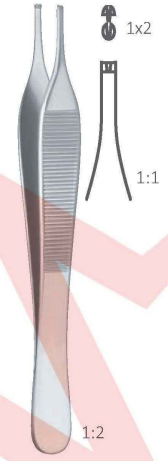

**Hudson (Ewald)**

120 mm – 4"	DF 03-155-01
-------------	--------------



**Potts-Smith**

180 mm – 7"	DF 03-150-01	DF 03-150-03
210 mm – 8 <sup>3</sup> / <sub>4</sub> "	DF 03-150-02	DF 03-150-02
250 mm – 9 <sup>3</sup> / <sub>4</sub> "	DF 03-150-03	DF 03-150-03

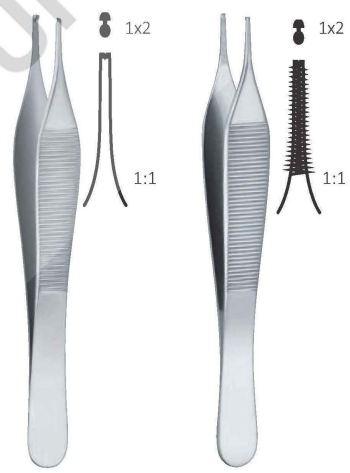

**Adson**

120 mm – 4 <sup>3</sup> / <sub>4</sub> "	DF 03-160-01	DF 03-161-01
150 mm – 6"	DF 03-160-02	DF 03-161-02



**Adson-Graefe**

120 mm – 4 <sup>3</sup> / <sub>4</sub> "	DF 03-165-01
--	--------------

**PINZETTEN – FORCEPS - Chirurgische Pinzetten - Tissue Forceps**

Pinces à dissection à griffes  
 Pinzas de disección con dientes  
 Pinze chirurgiche

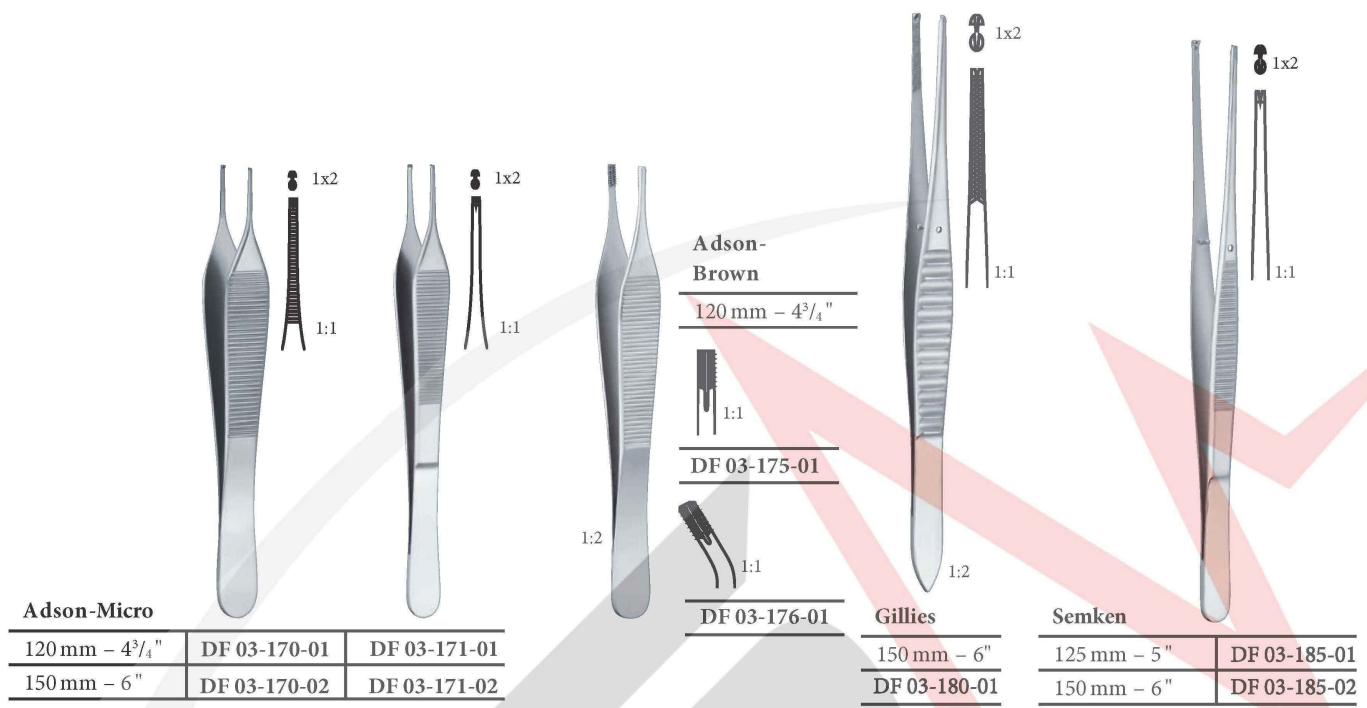

**Adson-Micro**

120 mm – 4 <sup>3</sup> / <sub>4</sub> "	DF 03-170-01	DF 03-171-01
150 mm – 6"	DF 03-170-02	DF 03-171-02

**Adson-Brown**

120 mm – 4<sup>3</sup>/<sub>4</sub>"

DF 03-175-01

**Gillies**

150 mm – 6"	DF 03-180-01
-------------	--------------

**Semken**

125 mm – 5"	DF 03-185-01
150 mm – 6"	DF 03-185-02

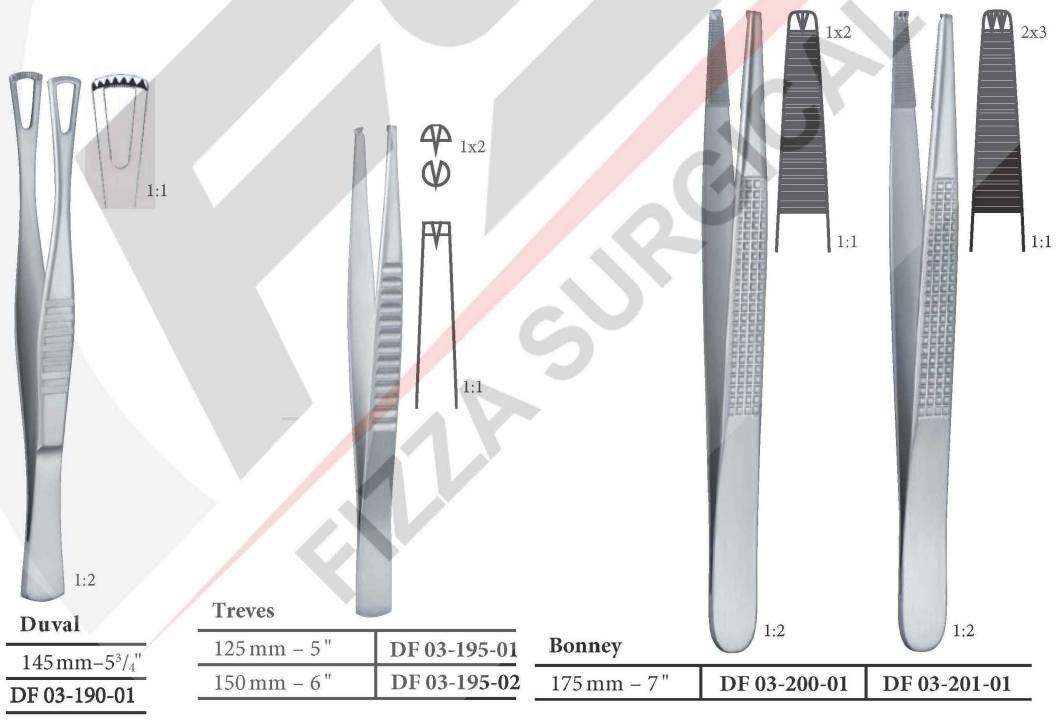

**Duval**

145 mm – 5 <sup>3</sup> / <sub>4</sub> "	DF 03-190-01
--	--------------

**Treves**

125 mm – 5"	DF 03-195-01
150 mm – 6"	DF 03-195-02

**Bonney**

175 mm – 7"	DF 03-200-01	DF 03-201-01
-------------	--------------	--------------

**PINZETTEN – FORCEPS - Chirurgische Pinzetten - Tissue Forceps**

Pinces à dissection à griffes  
 Pinzas de disección con dientes  
 Pinze chirurgiche

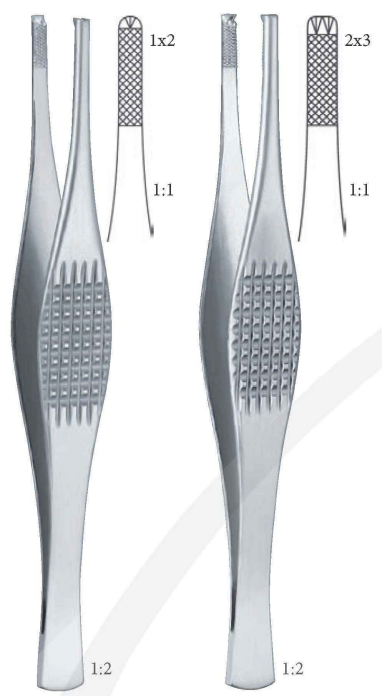

<b>Ferris-Smith</b>	1:2	1:2
180 mm – 7"	DF 03-205-01	DF 03-206-01

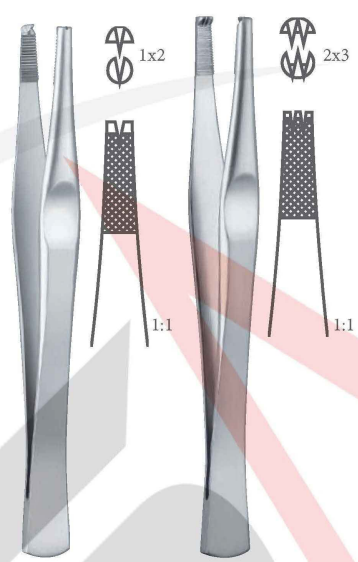

<b>Lane</b>		
145 mm – 5 1/2"	DF 03-210-01	DF 03-211-01
200 mm – 8"	DF 03-210-02	DF 03-211-02

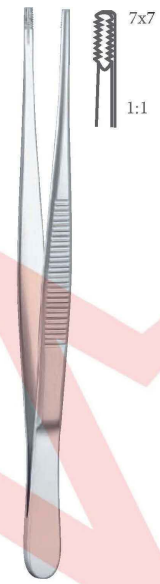

<b>Brown</b>		
150 mm – 6"	DF 03-215-01	
200 mm – 8"	DF 03-215-02	
250 mm – 9 3/4"	DF 03-215-03	

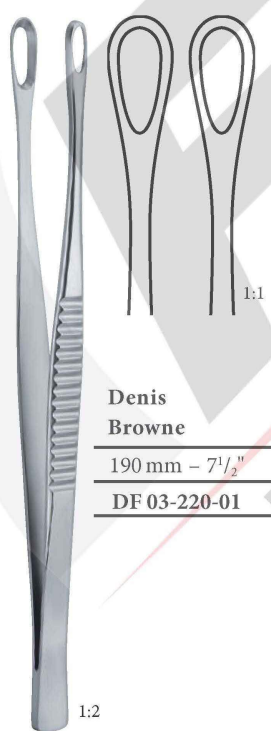

<b>Denis Browne</b>	
190 mm – 7 1/2"	DF 03-220-01



<b>Waugh</b>	
150 mm – 6"	DF 03-225-01
200 mm – 8"	DF 03-225-02
250 mm – 9 3/4"	DF 03-225-03



<b>Stille-Barraya</b>	
180 mm – 7"	DF 03-230-01
200 mm – 8"	DF 03-230-02
250 mm – 9 3/4"	DF 03-230-03

**PINZETTEN – FORCEPS - Chirurgische Pinzetten - Tissue Forceps**

Pinces à dissection à griffes  
 Pinzas de disección con dientes  
 Pinze chirurgiche



**Taylor**

175 mm - 7"	DF 03-235-01	DF 03-236-01	DF 03-237-01
-------------	--------------	--------------	--------------



**Cushing**

170 mm - 6 <sup>3</sup> / <sub>4</sub> "	DF 03-245-01	DF 03-246-01
--	--------------	--------------



**Gerald**

170 mm - 6 <sup>3</sup> / <sub>4</sub> "	DF 03-240-01	DF 03-241-01	
180 mm - 7"			DF 03-242-01

**PINZETTEN - FORCEPS - Ear and Nose Dressing Forceps**

Ohr- und Nasen pinzetten  
 Pincés auriculaires et nasaux  
 Pinzas auriculares y nasales  
 Pinze auricolari e nasali

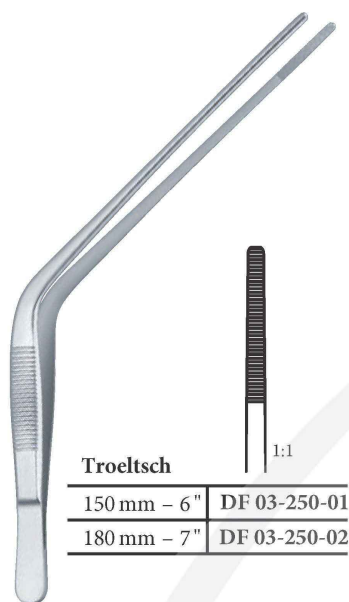

**Troeltsch**

150 mm - 6"	DF 03-250-01
180 mm - 7"	DF 03-250-02

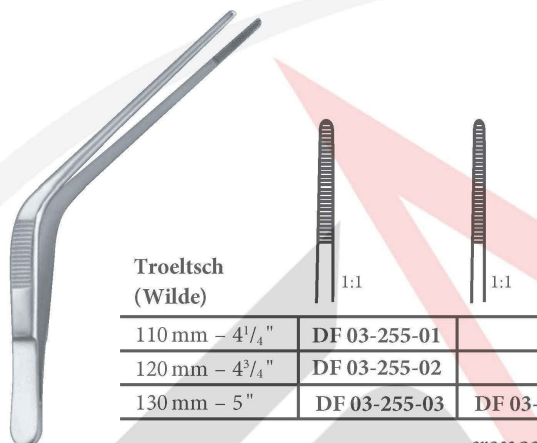

**Troeltsch (Wilde)**

110 mm - 4 <sup>1</sup> / <sub>4</sub> "	DF 03-255-01	
120 mm - 4 <sup>3</sup> / <sub>4</sub> "	DF 03-255-02	
130 mm - 5"	DF 03-255-03	DF 03-256-01

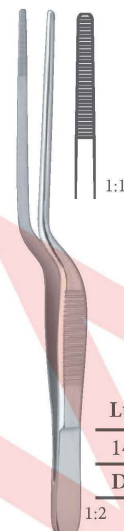

**Lucae**

140 mm - 5 <sup>1</sup> / <sub>2</sub> "	DF 03-260-01
--	--------------

cross action



**Jansen**

160 mm - 6 <sup>1</sup> / <sub>4</sub> "	DF 03-261-01
--	--------------



**Jansen**

160 mm - 6 <sup>1</sup> / <sub>4</sub> "	DF 03-265-01
200 mm - 8"	DF 03-265-02



**Cottle**

145 mm - 5 <sup>3</sup> / <sub>4</sub> "	DF 03-270-01
--	--------------



105 mm - 4 <sup>1</sup> / <sub>4</sub> "	DF 03-275-01
--	--------------

*Columellaforceps*

**INZETTEN-FORCEPS - Iris pinzetten - Iris forceps**

Pinces à iridectomie  
 Pinzas para Iris  
 Pinze per  
 iridectomia



**Graefe**

105 mm - 4 <sup>1</sup> / <sub>4</sub> "	DF 03-280-01	DF 03-281-01	DF 03-282-01	DF 03-285-01	DF 03-286-01	DF 03-287-01
--	--------------	--------------	--------------	--------------	--------------	--------------



**Graefe**

	70 mm - 2 <sup>3</sup> / <sub>4</sub> "	70 mm - 2 <sup>3</sup> / <sub>4</sub> "	70 mm - 2 <sup>3</sup> / <sub>4</sub> "	70 mm - 2 <sup>3</sup> / <sub>4</sub> "
0.7 mm	DF 03-290-01	DF 03-291-01	DF 03-292-01	DF 03-293-01
1.0 mm	DF 03-290-02	DF 03-291-02	DF 03-292-02	DF 03-293-02

**PINZETTEN-FORCEPS - Feine Pinzetten - Forceps Fine Patterns**

Pinces – modèles fines  
 Pinzas – modelos finos  
 Pinze – modelli fini



90 mm – 3 1/2"	<b>DF 03-295-01</b>	<b>DF 03-296-01</b>
105 mm – 4 1/4"	<b>DF 03-295-02</b>	<b>DF 03-296-02</b>
115 mm – 4 1/2"	<b>DF 03-295-03</b>	<b>DF 03-296-03</b>
125 mm – 5"	<b>DF 03-295-04</b>	<b>DF 03-296-04</b>

*smooth*

90 mm – 3 1/2"	<b>DF 03-300-01</b>	<b>DF 03-301-01</b>
105 mm – 4 1/4"	<b>DF 03-300-02</b>	<b>DF 03-301-02</b>
115 mm – 4 1/2"	<b>DF 03-300-03</b>	<b>DF 03-301-03</b>
125 mm – 5"	<b>DF 03-300-04</b>	<b>DF 03-301-04</b>

*serrated*

**PINZETTEN – FORCEPS - Fass Pinzetten - Grasping Forceps**

Pinces à saisir  
Pinzas para coger  
Pinze da presa



**Durante**

145 mm – 5 <sup>3</sup> / <sub>4</sub> "	DF 03-305-01
160 mm – 6 <sup>1</sup> / <sub>4</sub> "	DF 03-305-02
200 mm – 8"	DF 03-305-03



**Russ. Modell**

150 mm – 6"	DF 03-310-01
200 mm – 8"	DF 03-310-02
250 mm – 9 <sup>3</sup> / <sub>4</sub> "	DF 03-310-03
300 mm – 11 <sup>3</sup> / <sub>4</sub> "	DF 03-310-04

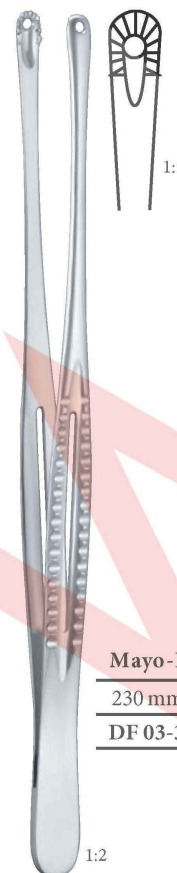

**Mayo-Russian**

230 mm – 9"	DF 03-315-01
-------------	--------------



**Nelson**

230 mm – 9"	DF 03-320-01
-------------	--------------



**Singley-Tuttle**

180 mm – 7"	DF 03-325-01
230 mm – 9"	DF 03-325-02
350 mm – 14"	DF 03-325-03



**Collin-Duval**

200 mm – 8"	x = 14 mm	DF 03-330-01
-------------	-----------	--------------



x = 18 mm	DF 03-330-02
-----------	--------------



x = 27 mm	DF 03-330-03
-----------	--------------

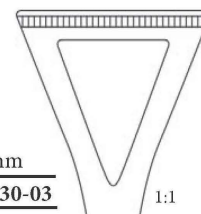



**PINZETTEN-FORCEPS - Atraumatische Pinzetten - Atraumatic Tissue Forceps**

Pinces atraumatiques  
 Pinzas de disección atraumáticas  
 Pinze per dissezione atraumatiche



**De Bakey**

	x = 1.5 mm	x = 2.0 mm	x = 2.7 mm	x = 3.5 mm
120 mm - 4 <sup>3</sup> / <sub>4</sub> "	DF 03-335-01			
145 mm - 5 <sup>3</sup> / <sub>4</sub> "	DF 03-335-02	DF 03-336-01		
160 mm - 6 <sup>1</sup> / <sub>4</sub> "	DF 03-335-03	DF 03-336-02	DF 03-337-01	DF 03-338-01
200 mm - 8"	DF 03-335-04	DF 03-336-03	DF 03-337-02	DF 03-338-02
240 mm - 9 <sup>1</sup> / <sub>2</sub> "	DF 03-335-05	DF 03-336-04	DF 03-337-03	DF 03-338-03
300 mm - 12"		DF 03-336-05	DF 03-337-04	DF 03-338-04
350 mm - 14"				DF 03-338-05

	x = 1.5 mm	x = 2.0 mm
145 mm - 5 <sup>3</sup> / <sub>4</sub> "	DF 03-339-01	
160 mm - 6 <sup>1</sup> / <sub>4</sub> "		DF 03-340-01
200 mm - 8"		DF 03-340-02
240 mm - 9 <sup>1</sup> / <sub>2</sub> "		DF 03-340-03
300 mm - 12"		DF 03-340-04

**PINZETTEN-FORCEPS - Atraumatische Pinzetten - Atraumatic Tissue Forceps**

Pinces atraumatiques  
 Pinzas de disección atraumáticas  
 Pinze per dissezione atraumatiche



De Bakey

	x = 1.2 mm	x = 1.5 mm	x = 1.8 mm	x = 2.0 mm	x = 2.8 mm
160 mm - 6 1/4"	DF 03-345-01	DF 03-346-01	DF 03-347-01	DF 03-348-01	DF 03-349-01
200 mm - 8"	DF 03-345-02	DF 03-346-02	DF 03-347-02	DF 03-348-02	DF 03-349-02
240 mm - 9 1/2"	DF 03-345-03	DF 03-346-03	DF 03-347-03	DF 03-348-03	DF 03-349-03

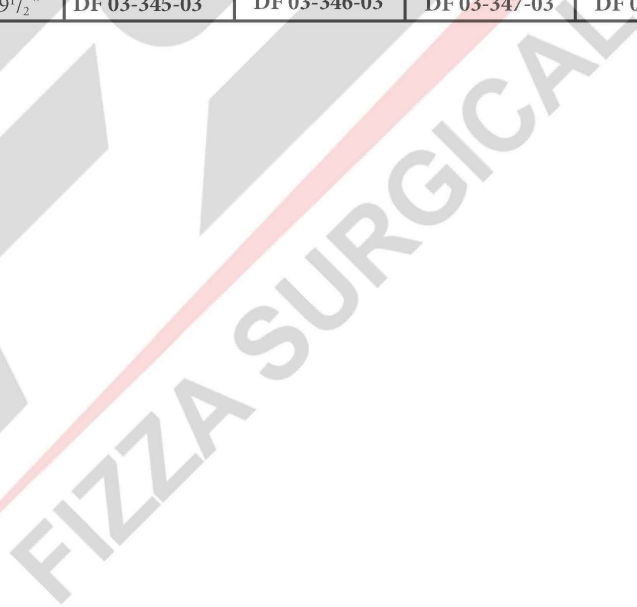

**PINZETTEN – FORCEPS - Anatomische Pinzetten - TC Dressing Forceps**

Pinces à dissection  
 Pinzas de disección  
 Pinze anatomiche

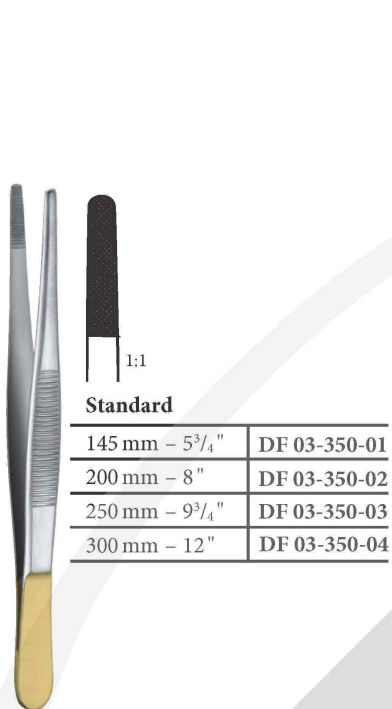

**Standard**

145 mm – 5 <sup>3</sup> / <sub>4</sub> "	DF 03-350-01
200 mm – 8"	DF 03-350-02
250 mm – 9 <sup>3</sup> / <sub>4</sub> "	DF 03-350-03
300 mm – 12"	DF 03-350-04

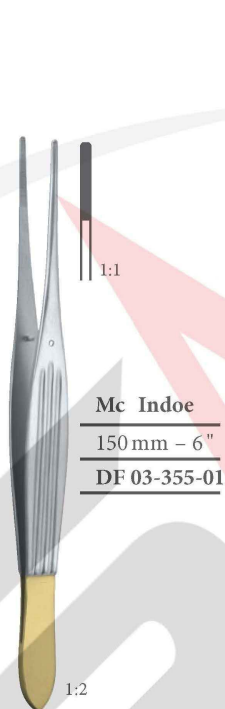

**Mc Indoe**

150 mm – 6"	DF 03-355-01
-------------	--------------



**Potts - Smith**

180 mm – 7"	DF 03-360-01
210 mm – 8 <sup>1</sup> / <sub>4</sub> "	DF 03-360-02
250 mm – 9 <sup>3</sup> / <sub>4</sub> "	DF 03-360-03



**Adson**

120 mm – 4 <sup>3</sup> / <sub>4</sub> "	DF 03-365-01
150 mm – 6"	DF 03-365-02



**Wangensteen**

150 mm – 6"	DF 03-370-01
230 mm – 9"	DF 03-370-02



**Cushing**

175 mm – 7"	DF 03-375-01
-------------	--------------



**Taylor**

180 mm – 7"	DF 03-380-01
-------------	--------------

**PINZETTEN-FORCEPS - Chirurgische Pinzetten - TC Tissue Forceps**

Pinces à dissection à griffes  
 Pinzas de disección con dientes  
 Pinze chirurgiche

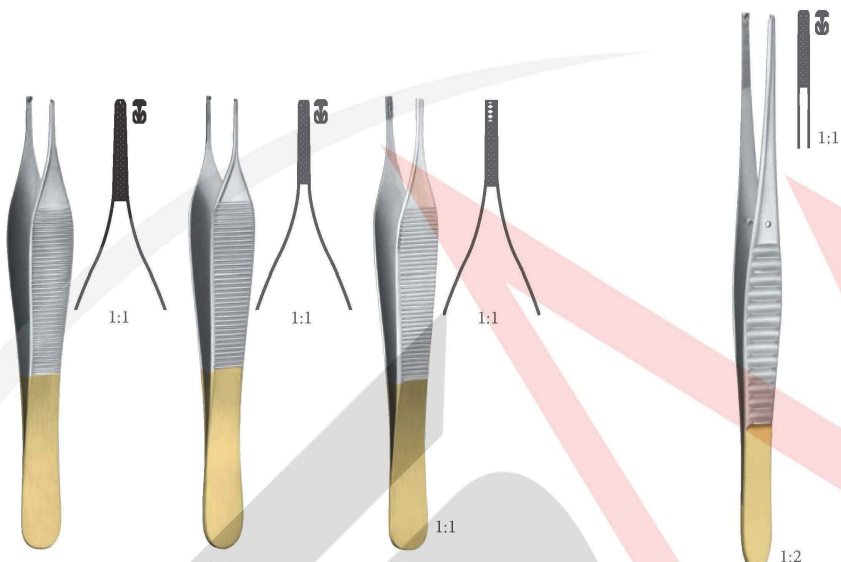







Adson	
120 mm - 4 <sup>3</sup> / <sub>4</sub> "	DF 03-385-01
150 mm - 6"	DF 03-385-02

Adson-Micro		Adson-Brown	
DF 03-390-01	DF 03-390-02	DF 03-395-01	

Gillies	
150 mm - 6"	DF 03-400-01



Oehler		
		
140 mm - 5 <sup>1</sup> / <sub>2</sub> "	160 mm - 4 <sup>1</sup> / <sub>4</sub> "	180 mm - 7"
DF 03-405-01	DF 03-405-02	DF 03-405-03

		
200 mm - 8"	250 mm - 9 <sup>3</sup> / <sub>4</sub> "	300 mm - 12"
DF 03-405-04	DF 03-405-05	DF 03-405-06

**PINZETTEN-FORCEPS -TC Atraumatic Tissue Forceps**

Atraumatische Pinzetten  
 Pincés atraumáticas  
 Pinzas de disección atraumáticas  
 Pinze per dissezione atraumatiche



De Bakey

	x = 1.5 mm	x = 2.0 mm
150 mm - 6"	DF 03-410-01	DF 03-411-01
190 mm - 7½"	DF 03-410-02	DF 03-411-02
240 mm - 9½"	DF 03-410-03	DF 03-411-03

**PINZETTEN - FORCEPS - Splitterpinzetten Splinter Forceps**

Pinces à échardes  
 Pinzas para espinas  
 Pinze fini per schegge



**Walter - Carmalt**

105 mm - 4 1/4"	DF 03-425-01	DF 03-426-01
-----------------	--------------	--------------



80 mm - 3 1/4"  
 DF 03-430-01



100 mm - 4"	DF 03-435-01
125 mm - 5"	DF 03-435-02



**Feilchenfeld**

75 mm - 3"	DF 03-415-01
90 mm - 3 1/2"	DF 03-415-02
115 mm - 4 1/2"	DF 03-415-03



**Hunter**

105 mm - 4 1/4"	DF 03-420-01	DF 03-421-01
-----------------	--------------	--------------

**PINZETTEN - FORCEPS - Cilien Pinzetten - Cilia Forceps**

Pinces à épiler *Pinzas depilatorias* Pinze per depilazione



**Beer**  
90 mm - 3 1/2"  
DF 03-440-01

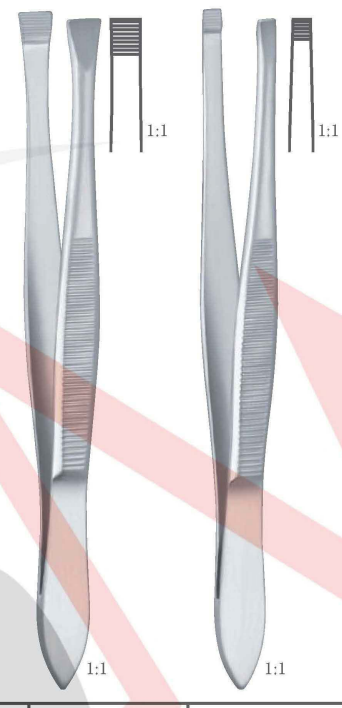

**Douglas**  
90 mm - 3 1/2" | DF 03-445-01 | DF 03-446-01



**Littauer**  
85 mm - 3 1/4" | DF 03-450-01  
90 mm - 3 1/2" | DF 03-451-01



**Barraquer**  
105 mm - 4 1/4"  
DF 03-460-01