

Retractors By Fizza Surgical International

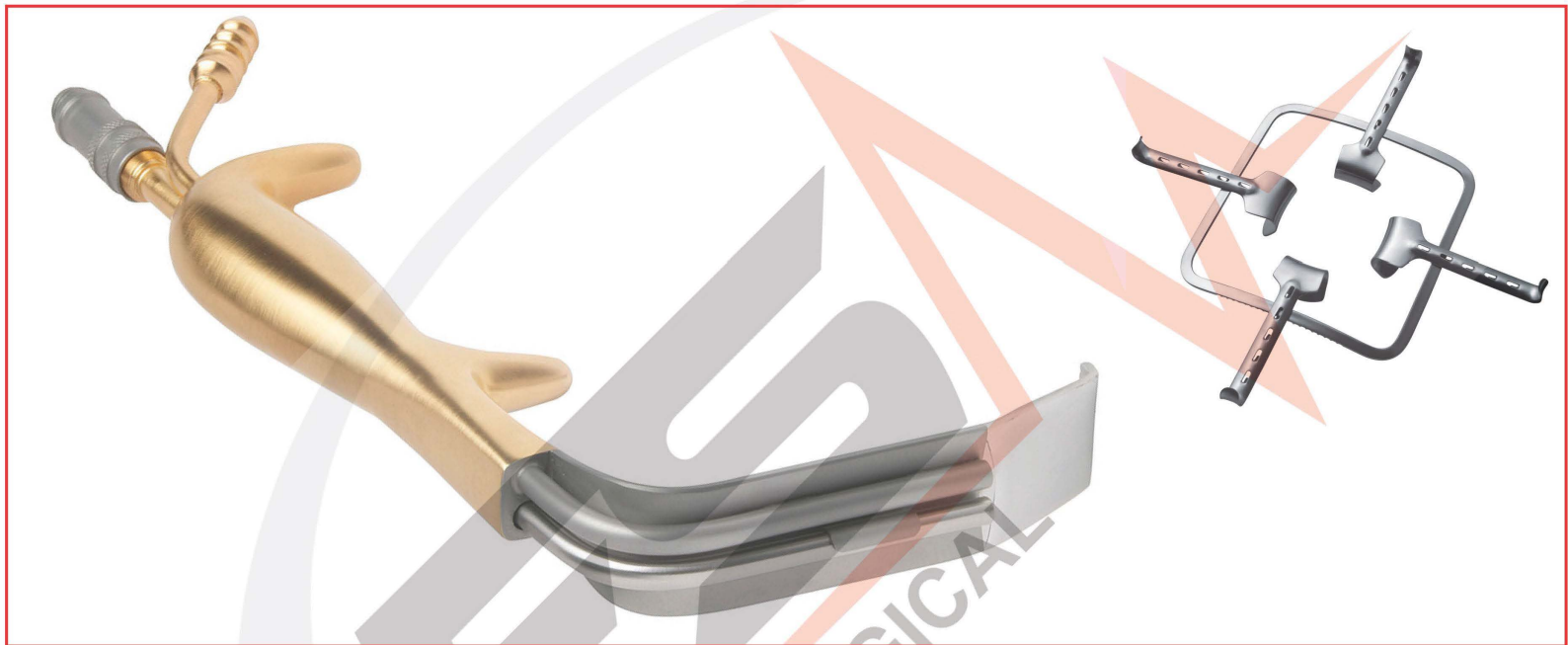



COMPANY PROFILE

Company name : FIZZA SURGICAL INTERNATIONAL

Company address : NARGATE STREET, JINNAH PARK , COLONY #2,,
Sialkot – 51310 Pakistan

PHONE : +92-52-460 4164

FAX : +92-52-458 0014

E-MAIL : info@fizzasurgical.com

Web site : www.fizzasurgical.com

LEGAL STATUS OF COMPANY : Partnership

PERSON TO CONTACT : NAJAF ALI
DESIGNATION : Partner
info@fizzasurgical.com

PERSON TO CONTACT : NAJAM ALI
DESIGNATION : Partner
Najam.Ali@fizzasurgical.com

PERSON TO CONTACT : ALI HASSAN
DESIGNATION : Partner
Ali.Hassan@fizzasurgical.com

Products manufacture: GYNECOLOGY INSTRUMENTS, ALL TYPE OF SCISSORS,
RFORCEPS AND ETRACTORS etc.

O.E.M. We can produce any type of vaginal speculums, retractors, dilators
Forceps, Scissors etc.
Also on O.E.M. basis if the drawings or Master samples are
provided To us by the customer.

Areas of Exports : Germany, France, Japan, U.K. etc.

CERTIFICATION : ISO 9001 : 2008
ISO 13485 : 2003
CE CERTIFICATION BY MHRA – UK
EC DECLARATION OF CONFORMITY

QUALITY POLICY : CUSTOMER'S SATISFACTION

MISSION STATEMENT : TO BECOME TOP MOST MEDICAL COMPANY IN PAKISTAN

Brief History of the company: Fizza Surgical International has made revolutionary changes in its manufacturing procedures from hand-made to modern machinery during the last 3 decades. Highly skilled workers are Proficiently working on these machinery multiplying production figures on one hand and having improved the quality of products to entire satisfaction of the customers.

Materials used in production : The materials used in production of these medical instruments conform to internationally recognized standards; viz. Grade AISI-410, Grade AISI-420 and Grade AISI-304. We use Japanese, German and French stainless steels.

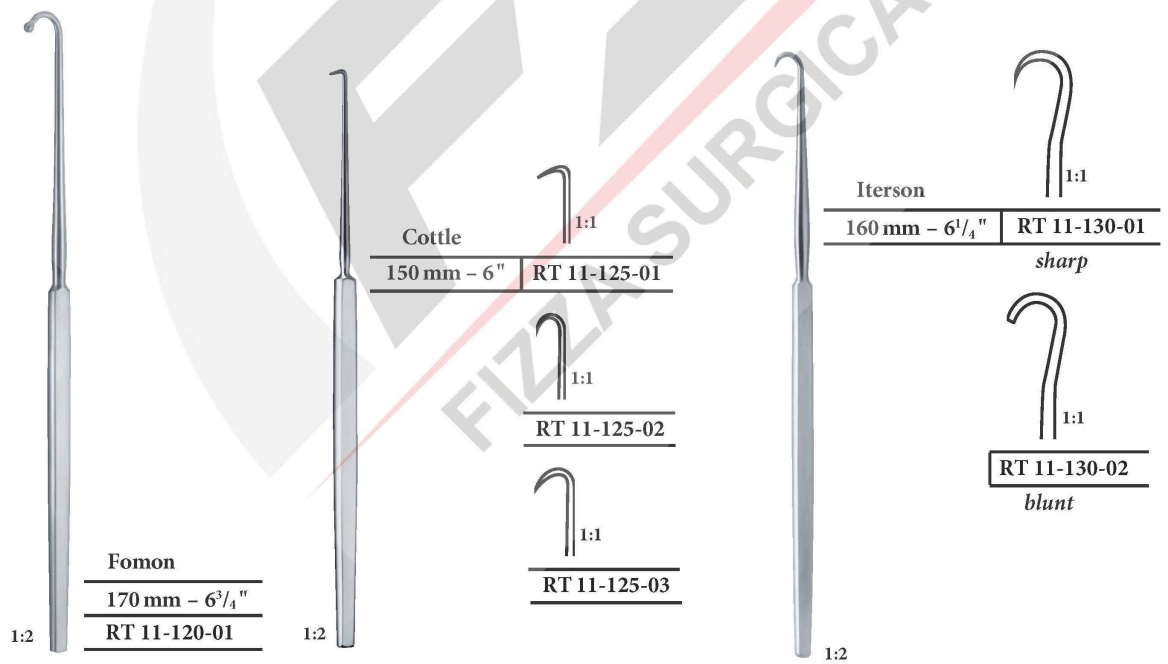
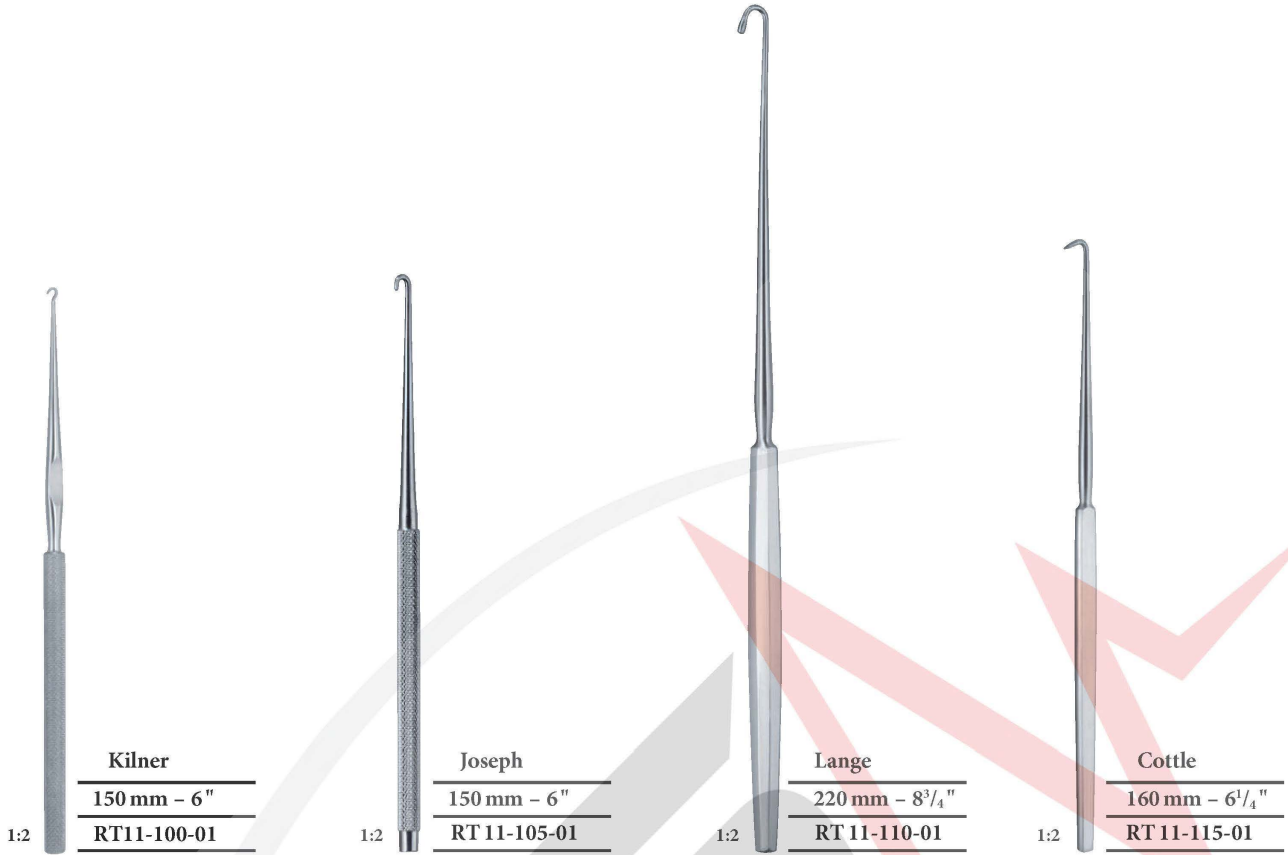

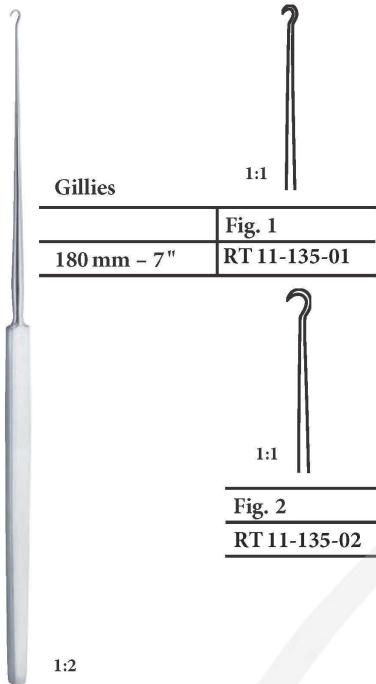

Gillies

180 mm - 7"	Fig. 1
	RT 11-135-01

Fig. 2

	RT 11-135-02
--	--------------



Fomon

160 mm - 6 1/4"
RT 11-145-01

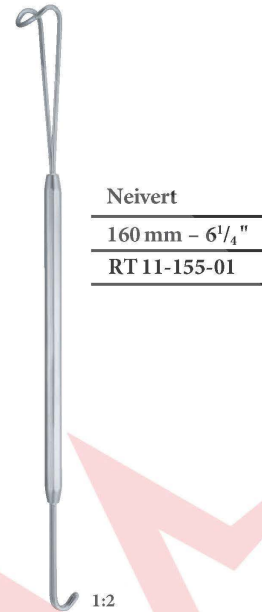

Neivert

160 mm - 6 1/4"
RT 11-155-01

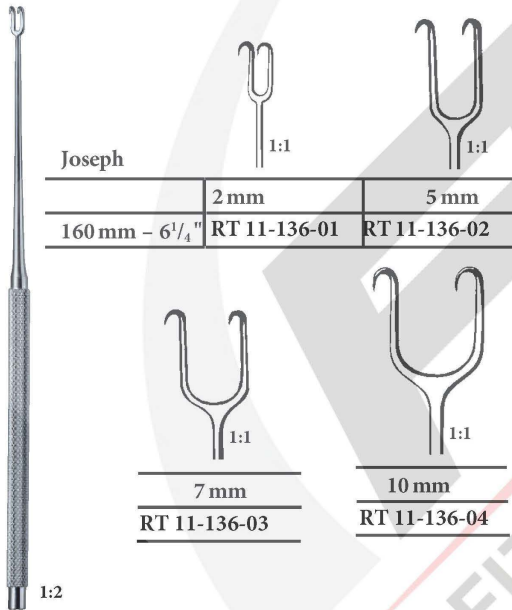

Joseph

160 mm - 6 1/4"	2 mm	5 mm
	RT 11-136-01	RT 11-136-02

7 mm	10 mm
RT 11-136-03	RT 11-136-04

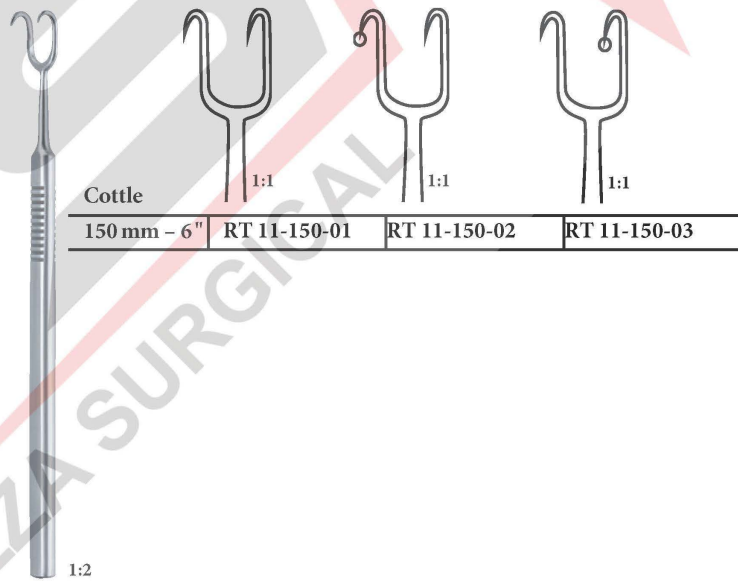

Cottle

150 mm - 6"	RT 11-150-01	RT 11-150-02	RT 11-150-03
-------------	--------------	--------------	--------------



Cottle - Neivert

200 mm - 8"
RT 11-140-01



Cottle

150 mm - 6"	RT 11-160-01	RT 11-160-02
-------------	--------------	--------------



Converse

120 mm - 4 ³ / ₄ "
RT 12-175-01

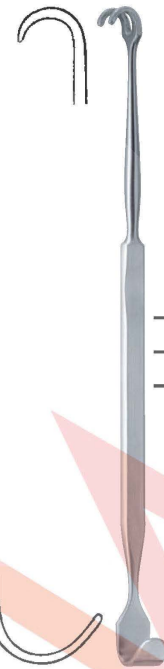

Jackson

170 mm - 6 ² / ₃ "
RT 11-190-01



Aufricht

190 mm - 6 ¹ / ₄ "
RT 11-165-01



Jackson

150 mm - 6"
RT 11-180-01

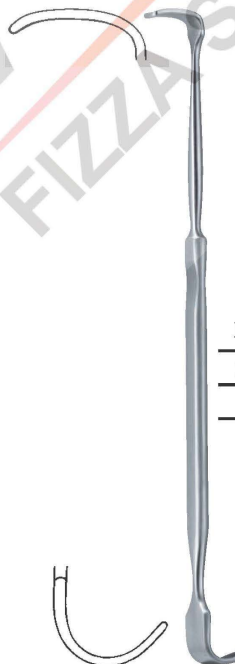

Lukens

170 mm - 6 ² / ₃ "
RT 11-185-01
<i>blunt</i>



Jackson

180 mm - 7"	RT 11-195-01
-------------	--------------

blunt

RT 11-195-02

sharp



Kilner

100 mm - 4"
RT 11-170-01

1:2

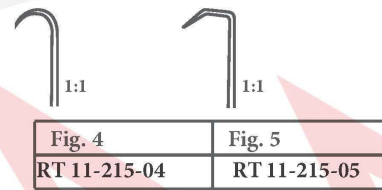
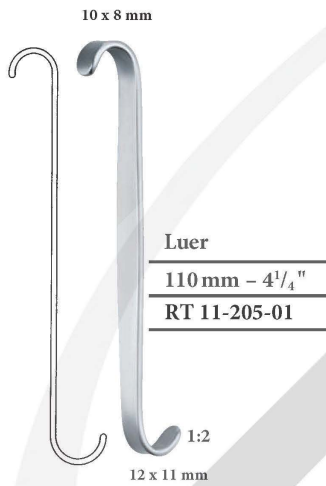
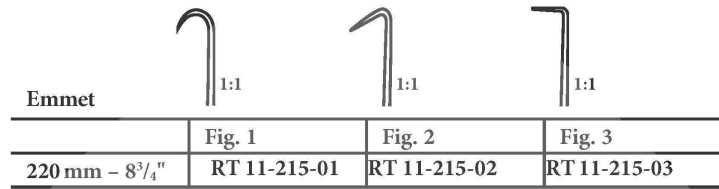
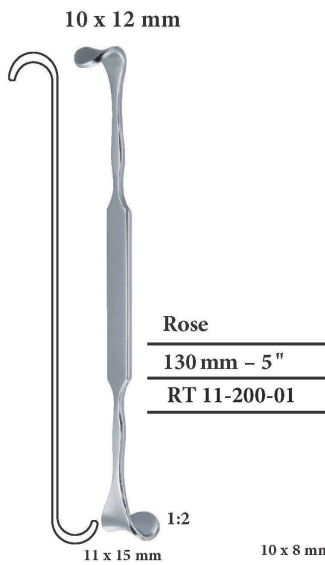



Sharp

160 mm - 6 ¹ / ₄ "
--

Blunt

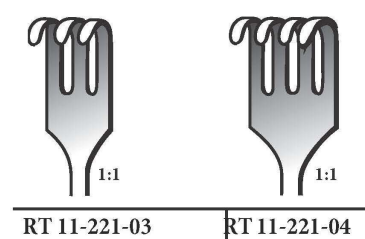
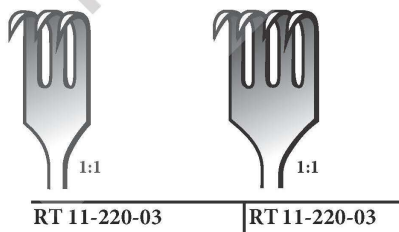
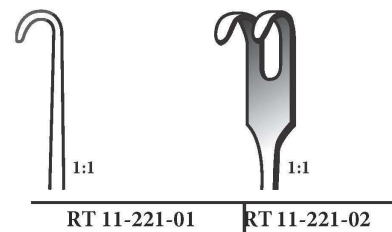
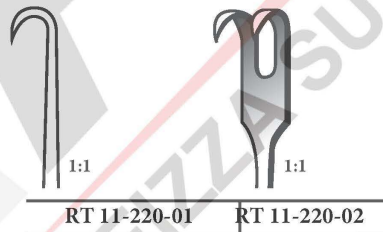

160 mm - 6 ¹ / ₄ "
--





flexible, sharp

160 mm - 6 ¹ / ₄ "	RT 11-222-01
--	--------------





RT 11-222-02	RT 11-222-03
--------------	--------------

Flexible, Blunt



160 mm - 6 ¹ / ₄ "	RT 11-223-01
--	--------------

RT 11-223-02	RT 11-223-03
--------------	--------------





KNAPP (ROLLET)

160 mm - 6 ¹ / ₄ "
RT 11-230-01



flexible, sharp

MINI - LANGENBECK

160 mm - 6 ¹ / ₄ "	
--	--

10 mm x 6 mm	17 mm x 5 mm
RT 11-235-01	RT 11-235-02



20 mm x 6 mm	22 mm x 8 mm
RT 11-235-02	RT 11-235-03



DESMARRES



x = 8 mm
160 mm - 6 ¹ / ₄ "
RT 11-225-01





x = 10 mm	x = 12 mm
RT 11-225-02	RT 11-225-03

160 mm - 6¹/₄"



x = 14 mm
RT 11-225-04

x = 16 mm	x = 18 mm
RT 11-225-05	RT 11-225-06



FOMON
145 mm, 5 3/4"
RT 11-226-01

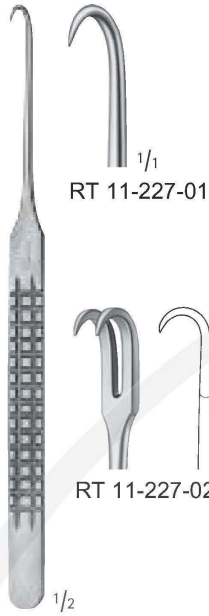

FOMON
160 mm, 6 1/4"
RT 11-227-01



RT 11-227-02



LANGENBECK-GREEN
160 mm, 6 1/4"
RT 11-228-01

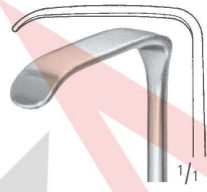

RT 11-228-02
24 x 6 mm

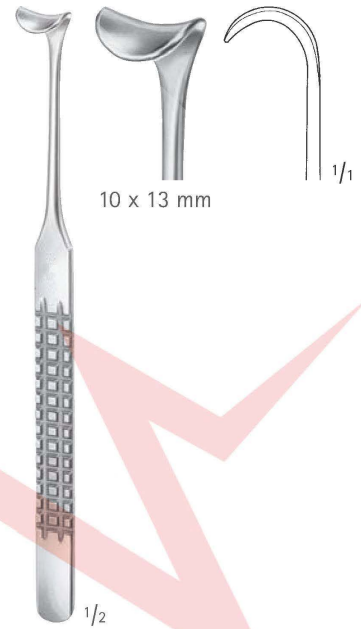

160 mm, 6 1/4"
RT 11-229-01



EMMET
220 mm, 8 3/4"
RT 11-231-01
Fistula hook



SIMON
220 mm, 8 3/4"
RT 11-232-01
Fistula hook



SIMON
220 mm, 8 3/4"
RT 11-233-01
Fistula hook



LANGE
235 mm, 9"
RT 11-234-01
Fistula hook

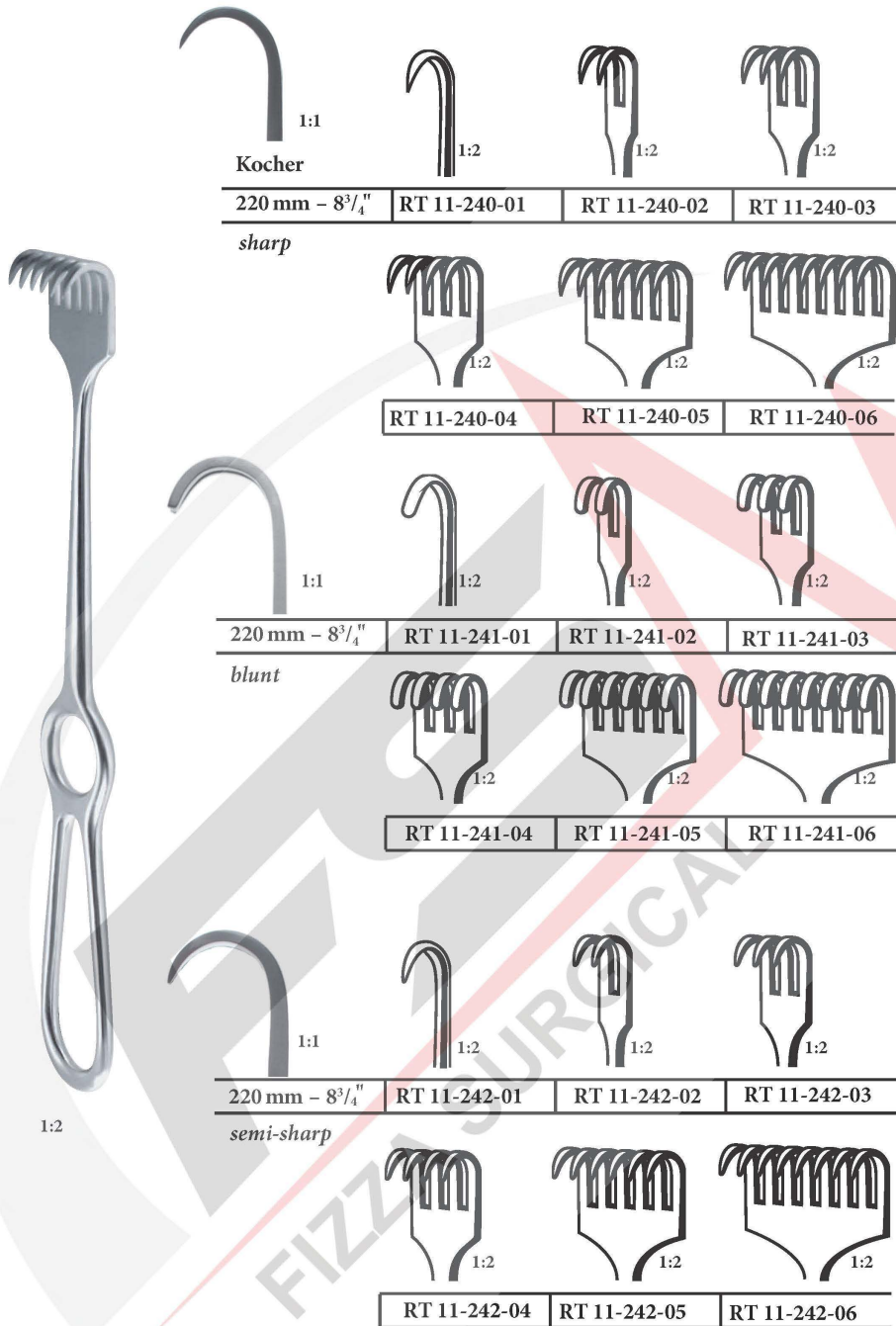





sharp VOLKMANN

 1:1	 1:2	 1:2
215 mm - 8 1/2"	RT 11-245-01	RT 11-245-02

 1:2	 1:2	 1:2
RT 11-245-03	RT 11-245-04	RT 11-245-05

blunt

 1:1	 1:2	 1:2
215 mm - 8 1/2"	RT 11-246-01	RT 11-246-02

 1:2	 1:2	 1:2
RT 11-246-03	RT 11-246-04	RT 11-246-05

semi-sharp

 1:1	 1:2	 1:2
215 mm - 8 1/2"	RT 11-247-01	RT 11-247-02

 1:2	 1:2	 1:2
RT 11-247-03	RT 11-247-04	RT 11-247-05



Volkmann
215 mm - 8 1/2" RT 11-250-01
sharp

1:1
RT 11-250-02
blunt



Kilner
155 mm - 6" RT 11-260-01



Senn - Green
20 mm x 6 mm
150 mm - 6" RT 11-270-01

1:1
10 mm x 6 mm
RT 11-270-02



1:1
Senn - Mueller
160 mm - 6 1/4" RT 11-255-01
sharp

1:1
RT 11-255-02
blunt



1:1
Strandell - Stille
20 mm x 6 mm
190 mm - 7 1/2" RT 11-265-01

1:1
saw edge
20 mm x 6 mm
RT 11-266-01

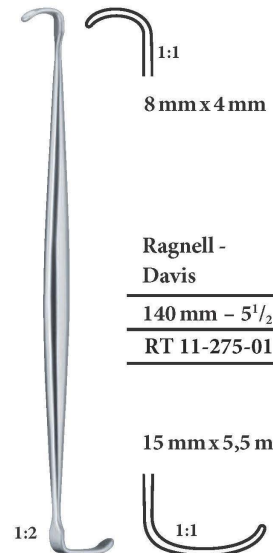

1:1
Ragnell - Davis
140 mm - 5 1/2" RT 11-275-01

1:1
15 mm x 5,5 mm



1:1



Cottle
150 mm - 6"
RT 11-280-01

1:2

11 x 4 mm

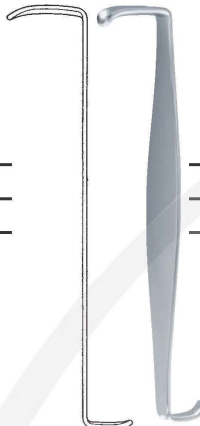

Crile
110 mm - 4 1/4"
RT 11-285-01

1:2

19 x 6 mm



1:2

Meyerdung



1:1



1:1

	18 mm x 7 mm	10 mm x 3 mm
180 mm - 7"	RT 11-295-01	RT 11-295-02



1:1



1:1

	16 mm x 5 mm	7 mm x 4 mm
180 mm - 7"	RT 11-295-03	RT 11-295-04



1:1



1:1

	10 mm x 4 mm	7 mm x 4 mm
180 mm - 7"	RT 11-295-05	RT 11-295-06



1:2

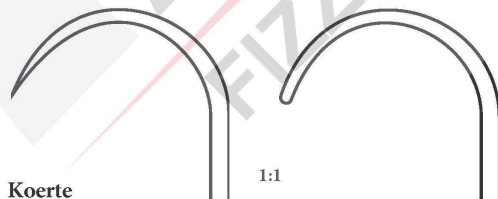

Koerte

1:1

1:1

	26 mm x 40 mm	26 mm x 40 mm
235 mm - 9 1/4"	RT 11-300-01	RT 11-300-02

scharf
sharp

stumpf
blunt



1:2

Green

215 mm - 8 1/2"	RT 11-305-01
-----------------	--------------



Middelдорpf

14 mm x 17 mm	20 mm x 22 mm	26 mm x 30 mm
215 mm - 8 ¹ / ₂ "	220 mm - 8 ³ / ₄ "	235 mm - 9 ¹ / ₄ "
RT 11-290-01	RT 11-290-02	RT 11-290-03

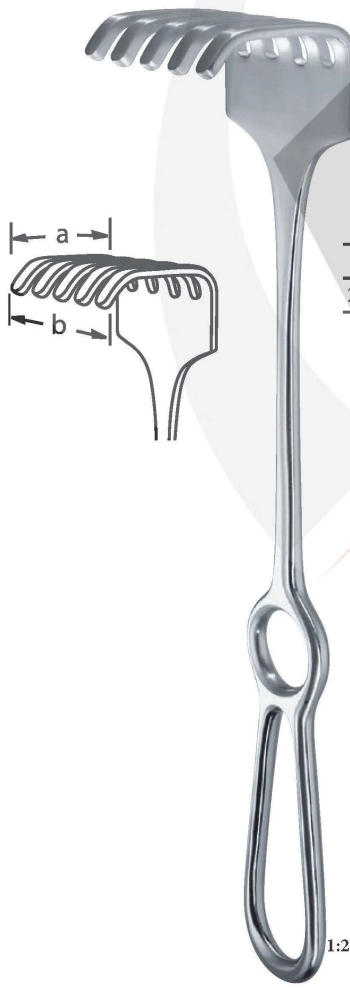

Israel

4 Teeth

1:1

a = 40 mm - b = 40 mm
250 mm - 9 ³ / ₄ "
RT 11-310-01

5 Teeth

1:1

a = 45 mm - b = 50 mm
RT 11-310-02

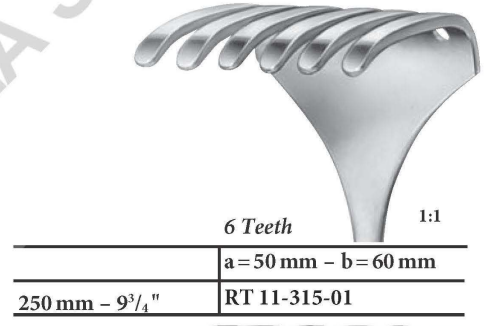
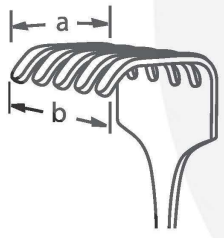

6 Teeth

1:1

a = 50 mm - b = 60 mm
250 mm - 9 ³ / ₄ "
RT 11-315-01

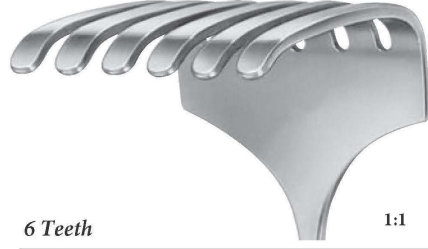

6 Teeth

1:1

a = 70 mm - b = 70 mm
RT 11-315-02

1:2



Langenbeck

220 mm - 8 3/4"



Fig. 1
30 mm x 11 mm

RT 11-320-01



Fig. 2
30 mm x 14 mm

RT 11-320-02



Fig. 3
30 mm x 16 mm

RT 11-320-03

1:2



220 mm - 8 3/4"



Fig. 4
40 mm x 11 mm

RT 11-320-04



Fig. 5
50 mm x 11 mm

RT 11-320-05



Langenbeck

210 mm - 8 1/4"



Fig. 1
30 mm x 11 mm

RT 11-325-01



Fig. 2
30 mm x 14 mm

RT 11-325-02



Fig. 3
30 mm x 16 mm

RT 11-325-03

1:2

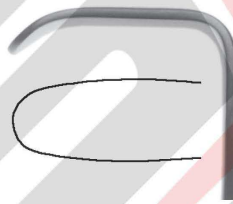

210 mm - 8 1/4"



Fig. 4
40 mm x 11 mm

RT 11-325-04



Fig. 5
50 mm x 11 mm

RT 11-325-05



**Kocher -Langenbeck
(Obwegeser)**

215 mm - 8 1/2"

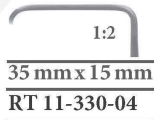
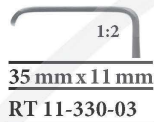

215 mm - 8 1/2"

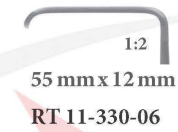
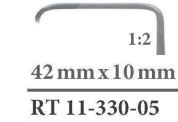

Cushing

200 mm - 8"
240 mm - 9 1/2"



200 mm - 8"
240 mm - 9 1/2"

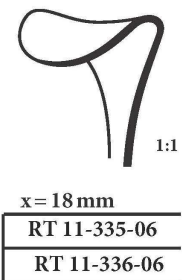
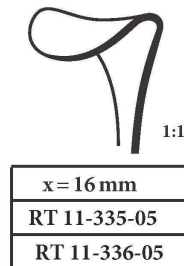
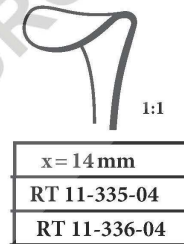



Obwegeser

220 mm - 8³/₄"

1:1

42 mm x 13 mm

RT 11-340-01



60 mm x 12 mm

RT 11-340-02



80 mm x 16 mm

RT 11-340-03

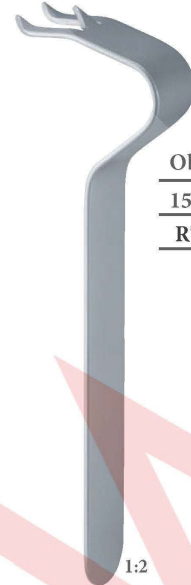

Obwegeser

155 mm - 6"

RT 11-350-01



Obwegeser

220 mm - 8³/₄"

1:1

44 mm x 9,5 mm

RT 11-345-01



70 mm x 11,5 mm

RT 11-345-02



Obwegeser

Malleable

160 mm - 6¹/₄"

x = 8 mm

RT 11-351-01

x = 10 mm

RT 11-351-02



Langenbeck
210 mm - 8¹/₄"
60 mm x 20 mm
RT 11-365-01

Ollier	a = 36 mm - b = 30 mm	a = 36 mm - b = 60 mm
<u>225 mm - 8³/₄"</u>	<u>RT 11-355-01</u>	<u>RT 11-355-02</u>



Kocher
210 mm - 8¹/₄"
55 mm x 11 mm
RT 11-360-01
40 mm x 12 mm
RT 11-360-02



Langenbeck
210 mm - 8¹/₄"
85 mm x 15 mm
RT 11-365-02

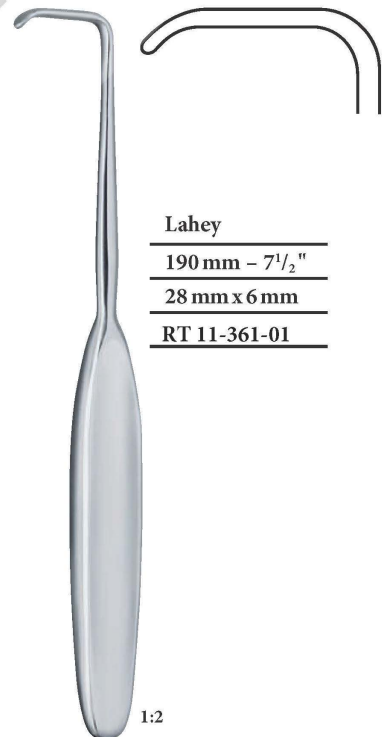

Lahey
190 mm - 7¹/₂"
28 mm x 6 mm
RT 11-361-01

Sauerbruch 1:1

45 mm x 15 mm
225 mm - 8 ³ / ₄ "
RT 11-370-01

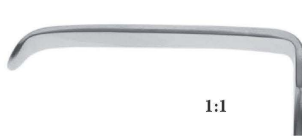

1:1

75 mm x 20 mm
RT 11-370-02

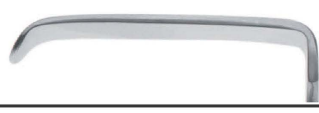

1:1

60 mm x 23 mm
220 mm - 8 ³ / ₄ "
RT 11-370-03



Kocher 1:1

19 mm x 12 mm
190 mm - 7 ¹ / ₂ "
RT 11-380-01



1:1

21 mm x 14 mm
RT 11-380-02





Kocher

40 mm x 10 mm
220 cm - 8 ³ / ₄ "
RT 11-380-03



40 mm x 15 mm
RT 11-380-04



40 mm x 20 mm
RT 11-380-05

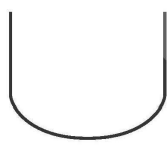

Richardson

240 mm - 9 ¹ / ₂ "
52 mm x 22 mm
RT 11-381-01



Kelly

260 mm - 10 ¹ / ₄ "
65 mm x 50 mm
RT 11-382-01

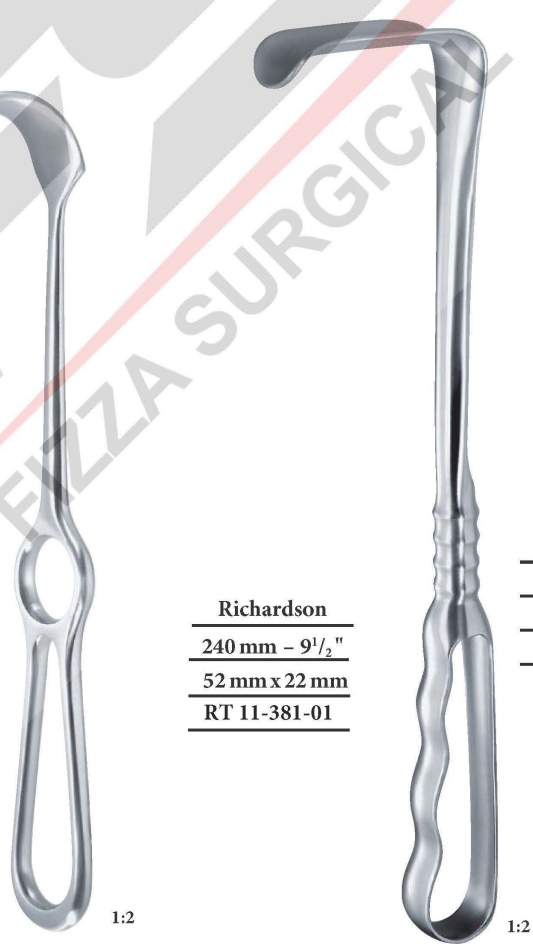

Kocher



	40 mm x 18 mm
230 mm - 9"	RT 11-385-01



	60 mm x 20 mm
	RT 11-385-02



	60 mm x 25 mm
	RT 11-385-03



	75 mm x 30 mm
	RT 11-385-04



	75 mm x 40 mm
	RT 11-385-05

1:2

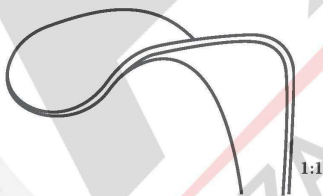

Richardson

	28 mm x 20 mm
240 mm - 9 1/2"	RT 11-390-01

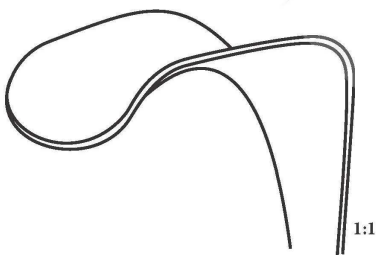

	36 mm x 28 mm
	RT 11-390-02

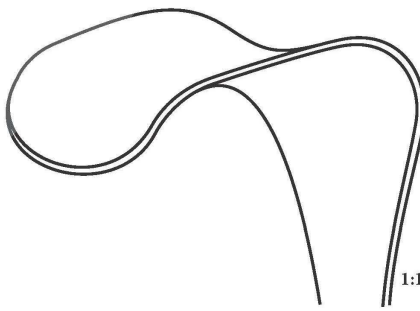

	44 mm x 38 mm
	RT 11-390-03



1:2

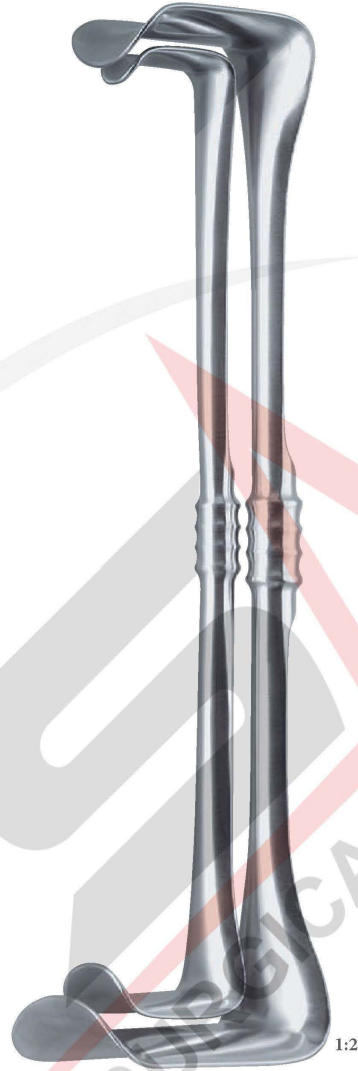

Richardson-Eastman

	Fig. 1	Fig. 2
	280 mm - 11"	260 mm - 10 ¹ / ₄ "
	49 mm x 38 mm	36 mm x 28 mm
	63 mm x 49 mm	28 mm x 20 mm
RT 11-391-01	x	
RT 11-391-02		x
RT 11-391-03	x	x



Handel
260 mm - 10¹/₄"

1:2

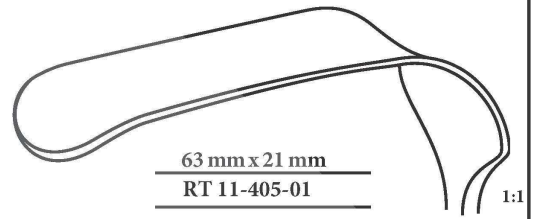

63 mm x 21 mm
RT 11-405-01

1:1

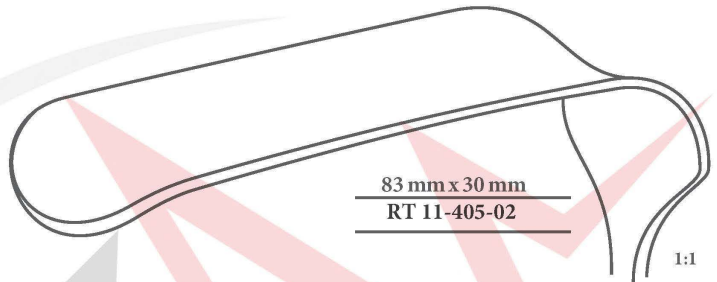

83 mm x 30 mm
RT 11-405-02

1:1

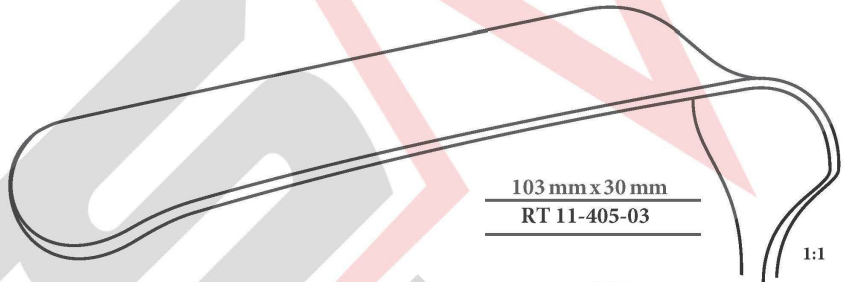

103 mm x 30 mm
RT 11-405-03

1:1

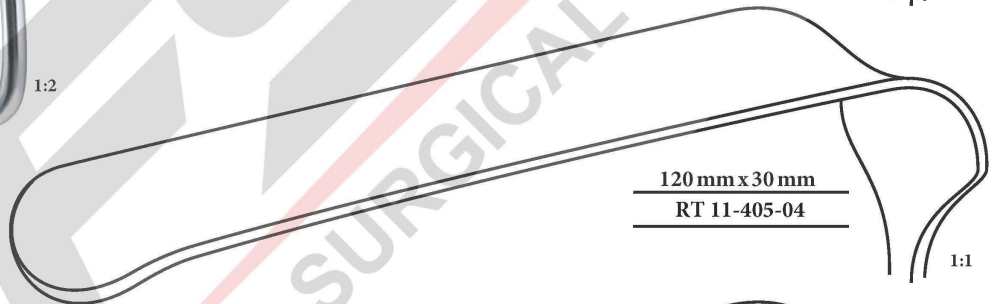

120 mm x 30 mm
RT 11-405-04

1:1



140 mm x 30 mm
RT 11-405-05

1:1

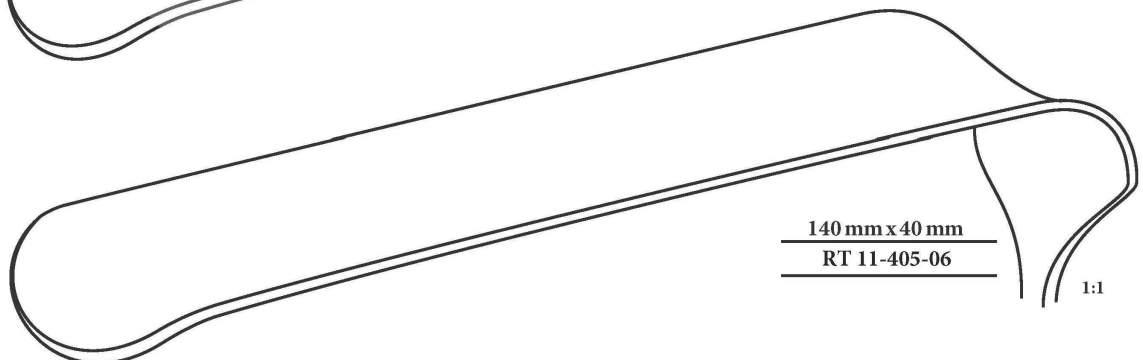

140 mm x 40 mm
RT 11-405-06

1:1

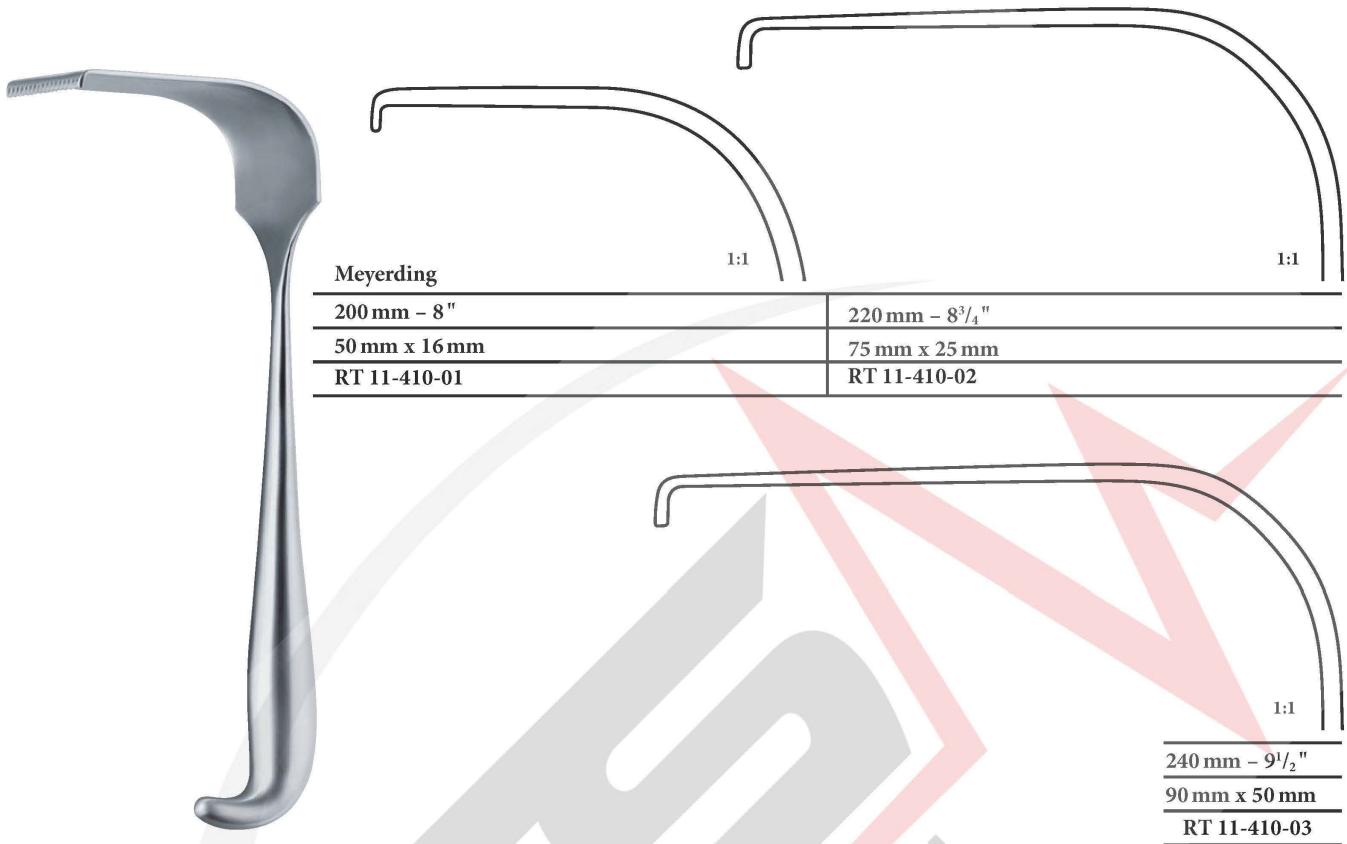

Meyerding

200 mm - 8"	220 mm - 8 ³ / ₄ "
50 mm x 16 mm	75 mm x 25 mm
RT 11-410-01	RT 11-410-02

240 mm - 9 ¹ / ₂ "
90 mm x 50 mm
RT 11-410-03

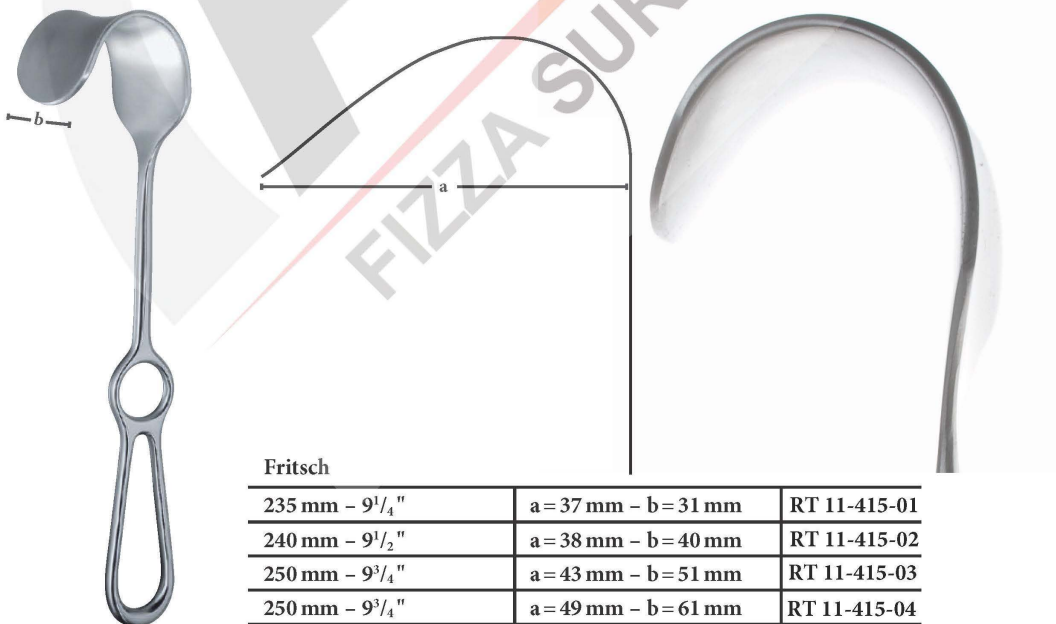

Fritsch

235 mm - 9 ¹ / ₄ "	a = 37 mm - b = 31 mm	RT 11-415-01
240 mm - 9 ¹ / ₂ "	a = 38 mm - b = 40 mm	RT 11-415-02
250 mm - 9 ³ / ₄ "	a = 43 mm - b = 51 mm	RT 11-415-03
250 mm - 9 ³ / ₄ "	a = 49 mm - b = 61 mm	RT 11-415-04
255 mm - 10"	a = 48 mm - b = 75 mm	RT 11-415-05
265 mm - 10 ¹ / ₂ "	a = 65 mm - b = 85 mm	RT 11-415-06



Simon

	115 mm x 22 mm	115 mm x 27 mm
280 cm - 11"	RT 11-420-01	RT 11-420-02

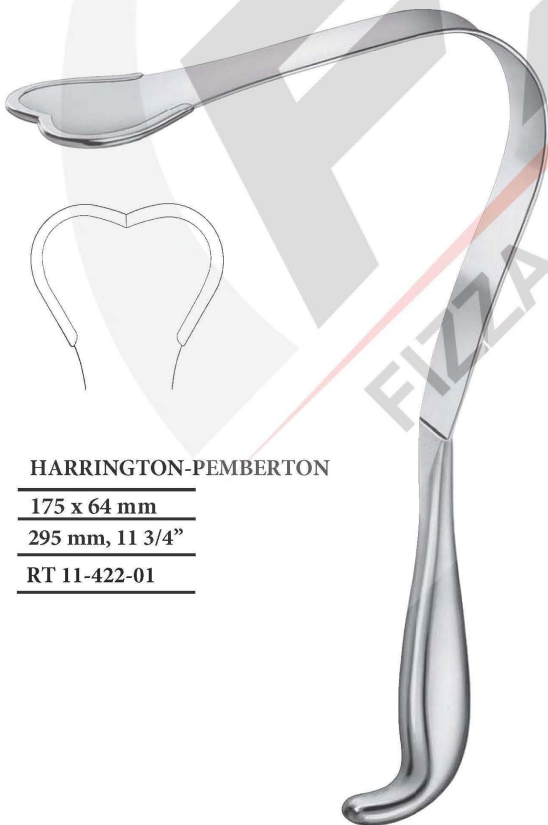

HARRINGTON-PEMBERTON

175 x 64 mm
295 mm, 11 3/4"
RT 11-422-01



HARRINGTON

320 mm - 12 1/2"
127 mm x 45 mm
RT 11-425-01
127 mm x 64 mm
RT 11-425-02



Mikulicz	1:1
	95 mm x 35 mm
260 mm - 10 ¹ / ₄ "	RT 11-430-01

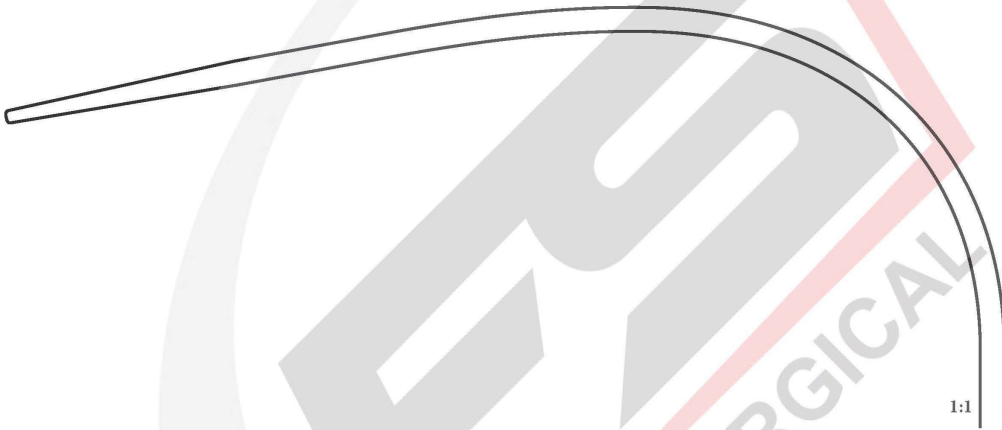
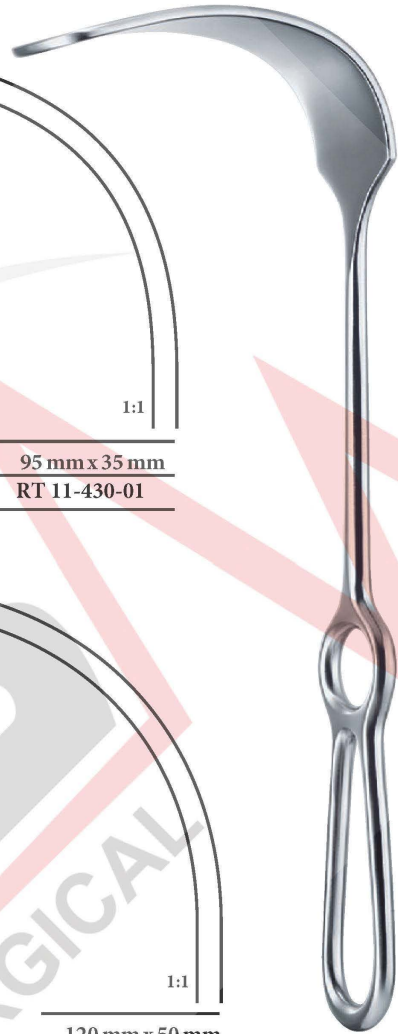

120 mm x 50 mm
RT 11-430-02

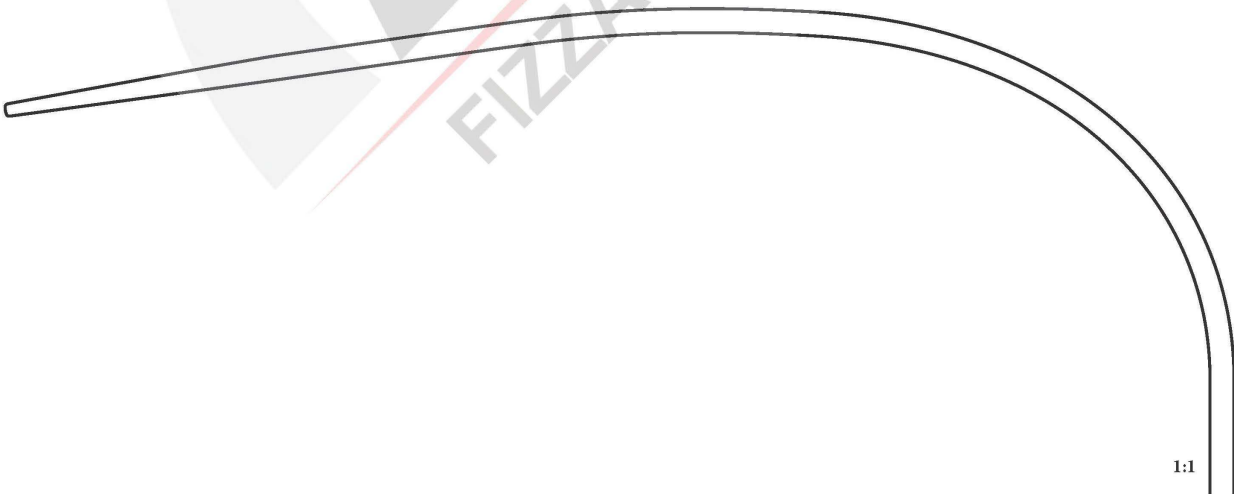

150 mm x 50 mm
RT 11-430-03



Mikulicz
260 mm - 10¹/₄"
90 mm x 50 mm
RT 11-435-01

1:2



Davidson

160 mm - 6¹/₄"

a = 75 mm - b = 50 mm

RT 11-440-01

a = 75 mm - b = 90 mm

RT 11-440-02



1:2



90x20mm

Modell Tubingen
260 mm, 10¹/₂"
RT 11-436-01

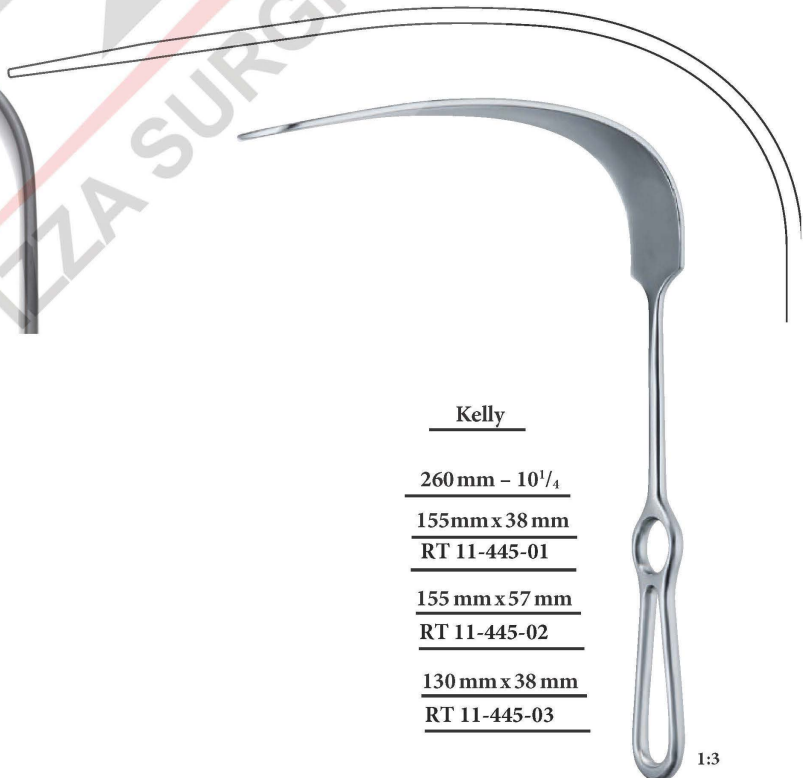

Kelly

260 mm - 10¹/₄"

155mm x 38 mm

RT 11-445-01

155 mm x 57 mm

RT 11-445-02

130 mm x 38 mm

RT 11-445-03

1:3

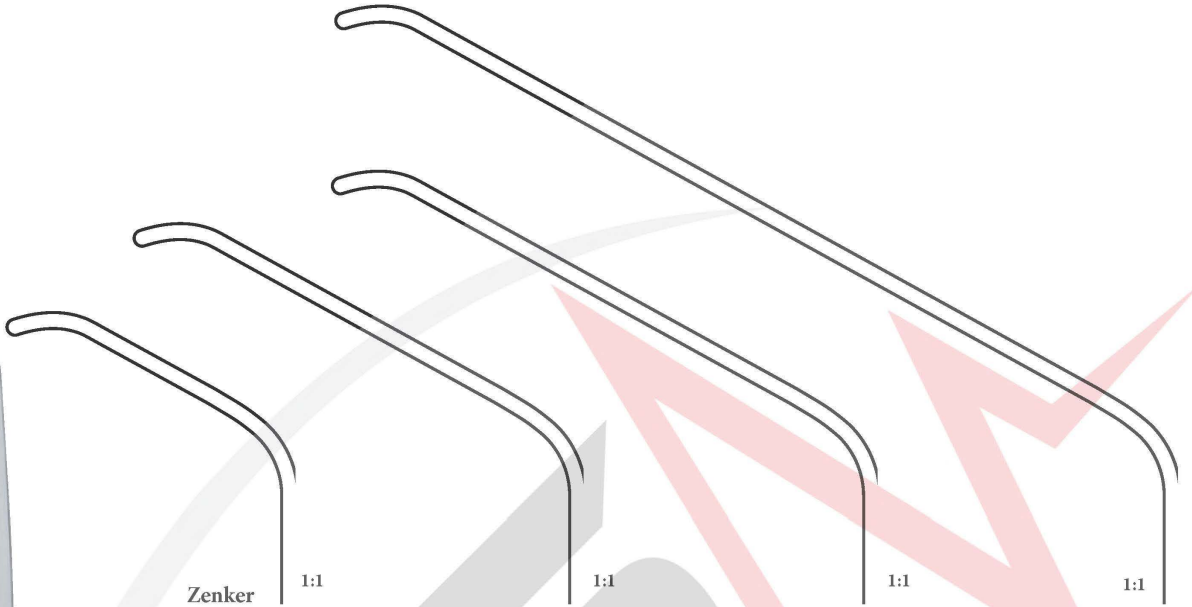

Zenker	1:1	1:1	1:1	1:1
250 mm - 9 ³ / ₄ "	260 mm - 10 ¹ / ₄ "	275 mm - 10 ³ / ₄ "	290 mm - 11 ¹ / ₂ "	
35 mm x 8 mm	60 mm x 12 mm	75 mm x 12 mm	120 mm x 12 mm	
RT 11-450-01	RT 11-450-02	RT 11-450-03	RT 11-450-04	

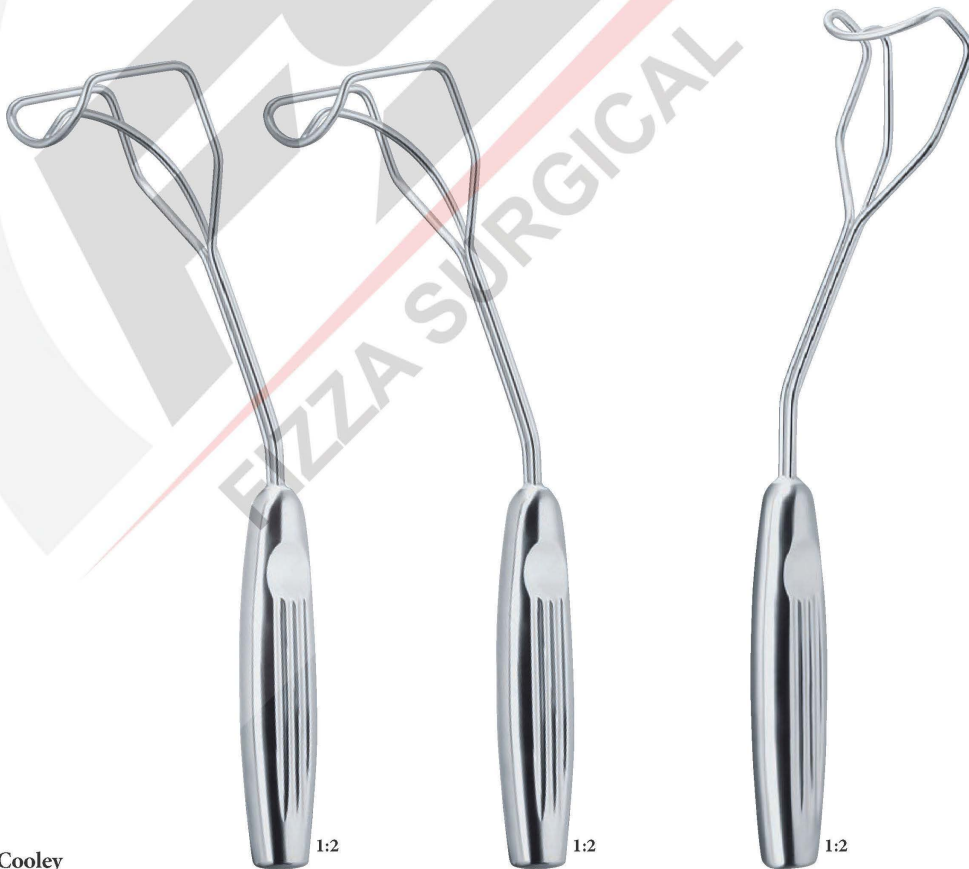

Cooley	1:2	1:2	1:2
250 mm - 9 ³ / ₄ "	250 mm - 9 ³ / ₄ "	270 mm - 10 ¹ / ₂ "	
RT 11-455-01	RT 11-455-02	RT 11-455-03	
Right	Right, serrated	Left	



1:2

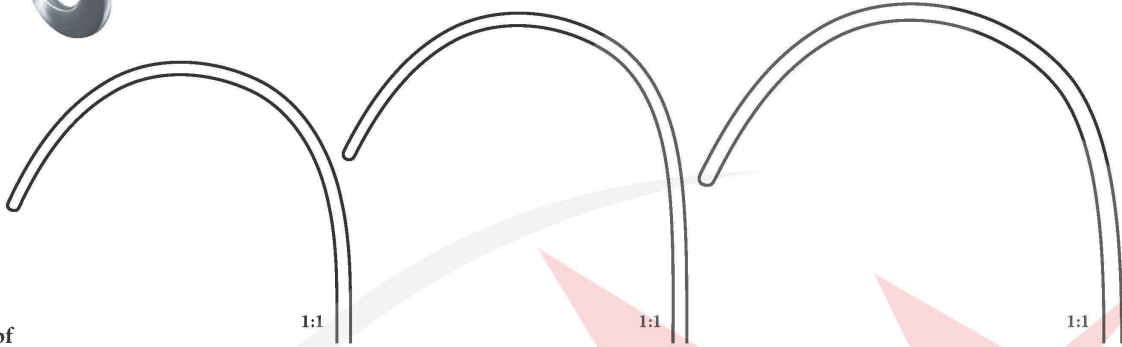

1:1

1:1

1:1

Middelдорpf

	45 mm x 45 mm	45 mm x 50 mm	55 mm x 70 mm
255 mm - 10"	RT 11-460-01	RT 11-460-02	RT 11-460-03



1:2

Doyen

250 mm - 9 ³ / ₄ "
50 mm x 85 mm
RT 11-465-01

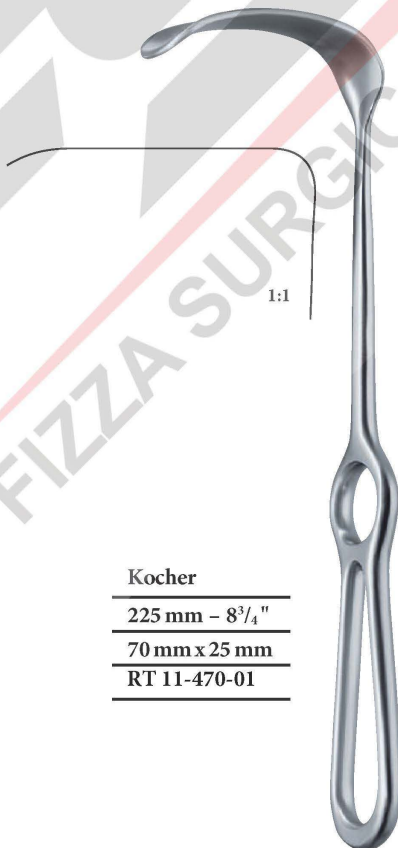

1:1

Kocher

225 mm - 8 ³ / ₄ "
70 mm x 25 mm
RT 11-470-01

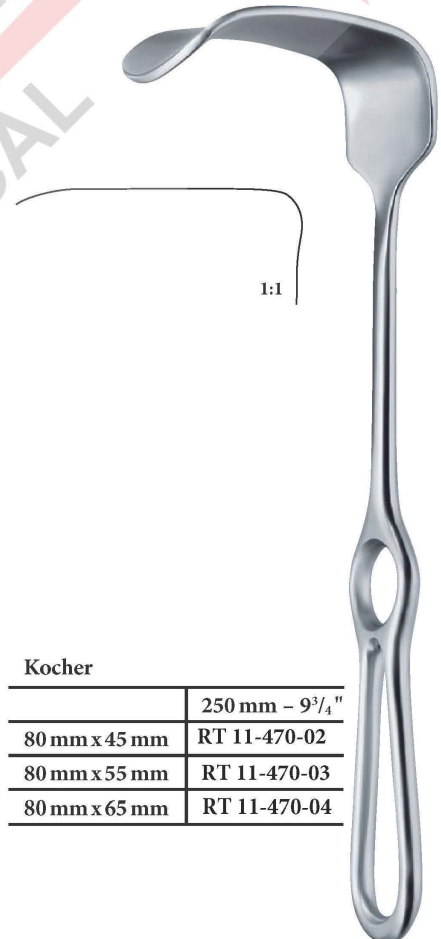

1:1

Kocher

	250 mm - 9 ³ / ₄ "
80 mm x 45 mm	RT 11-470-02
80 mm x 55 mm	RT 11-470-03
80 mm x 65 mm	RT 11-470-04

1:2

Morris

210 mm - 8 ¹ / ₄ "
50 mm x 55 mm
RT 11-530-01



Martin

250 mm - 9 ³ / ₄ "
105 mm x 27 mm
RT 11-480-01



Sauerbruch

250 mm - 9 ³ / ₄ "
125 mm x 37 mm
RT 11-485-01

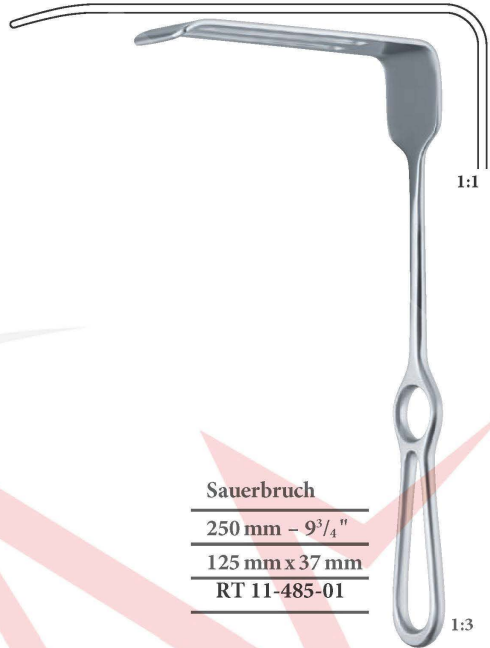

Heaney

270 mm - 10 ³ / ₄ "

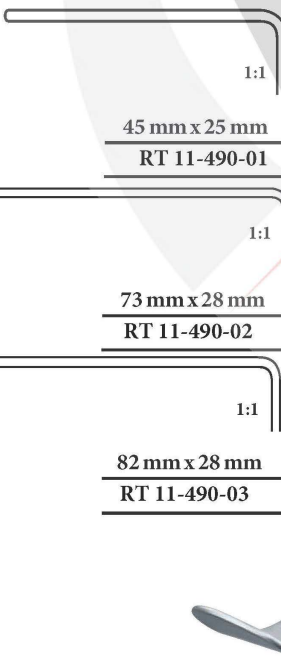

Coryllos

82 mm x 22 mm
240 mm - 9 ¹ / ₂ "
RT 11-495-01

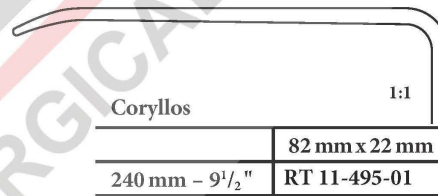

108 mm x 43 mm
RT 11-495-02



115 mm x 65 mm
RT 11-495-02





Brunner
250 mm - 9³/₄ "

1:2

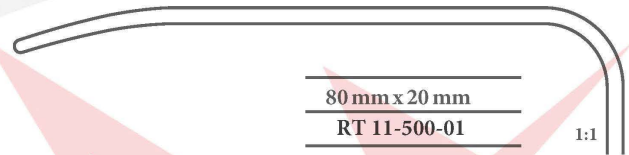

80 mm x 20 mm
RT 11-500-01

1:1



100 mm x 20 mm
RT 11-500-02

1:1



120 mm x 25 mm
RT 11-500-03

1:1



140 mm x 25 mm
RT 11-500-04

1:1



160 mm x 30 mm
RT 11-500-05







1:1

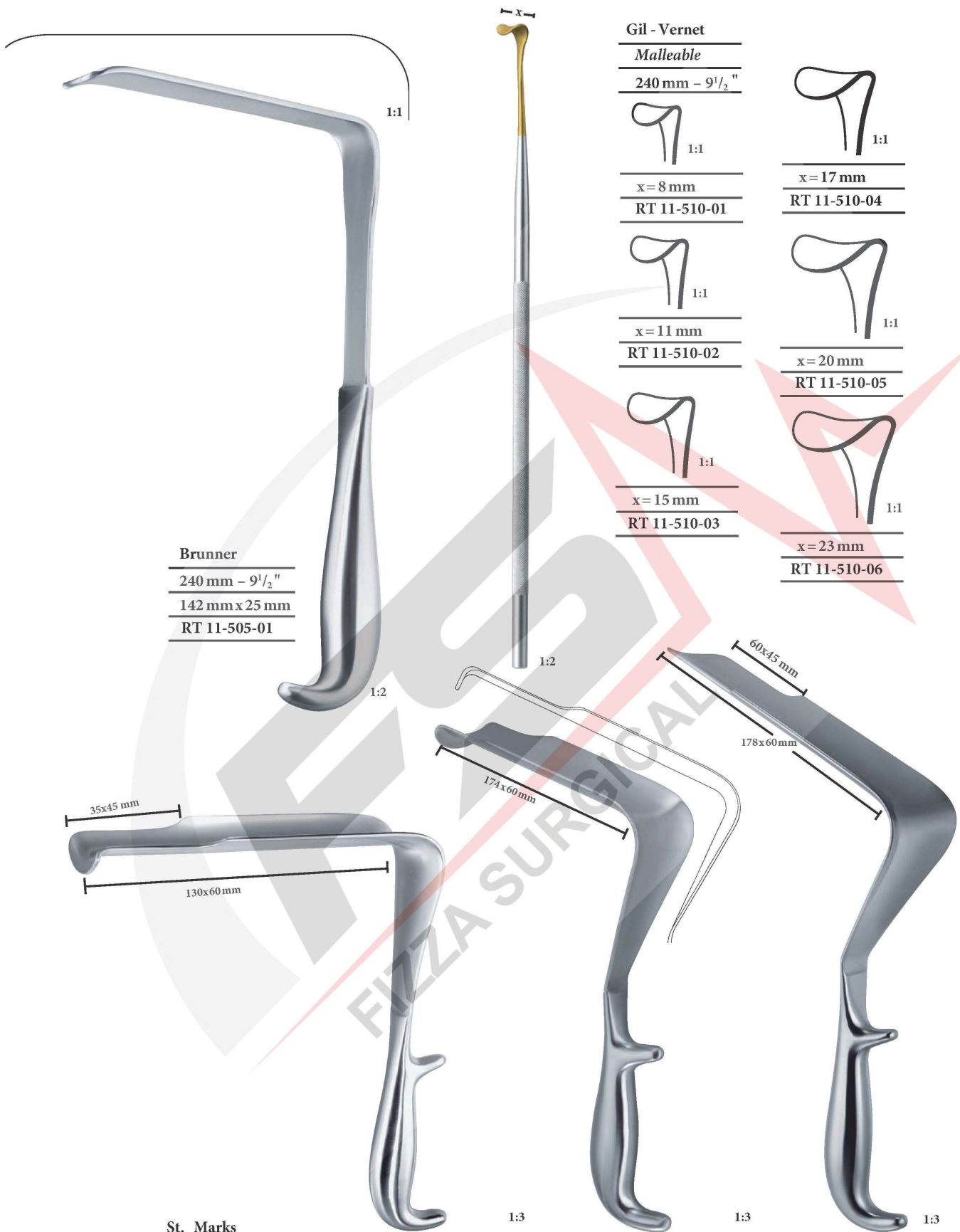

180 mm x 30mm
RT 11-500-06

1:1



	
x = 8 mm	x = 17 mm
RT 11-510-01	RT 11-510-04
	
x = 11 mm	x = 20 mm
RT 11-510-02	RT 11-510-05
	
x = 15 mm	x = 23 mm
RT 11-510-03	RT 11-510-06

St. Marks		
290 mm - 11 1/2"	325 mm - 12 3/4"	330 mm - 13"
130 mm x 60 mm	174 mm x 60 mm	178 mm x 60 mm
RT 11-515-01	RT 11-515-02	RT 11-515-03

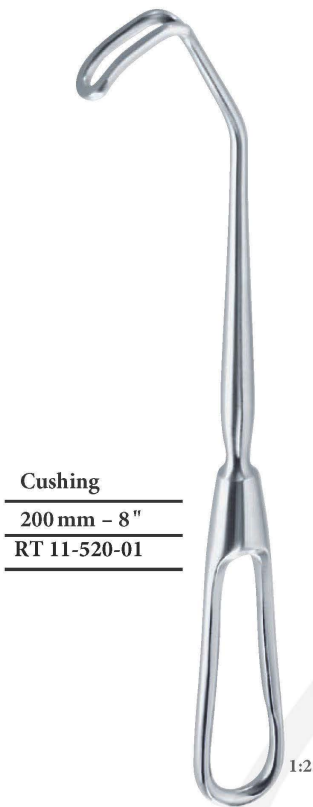

Cushing
200 mm - 8"
RT 11-520-01

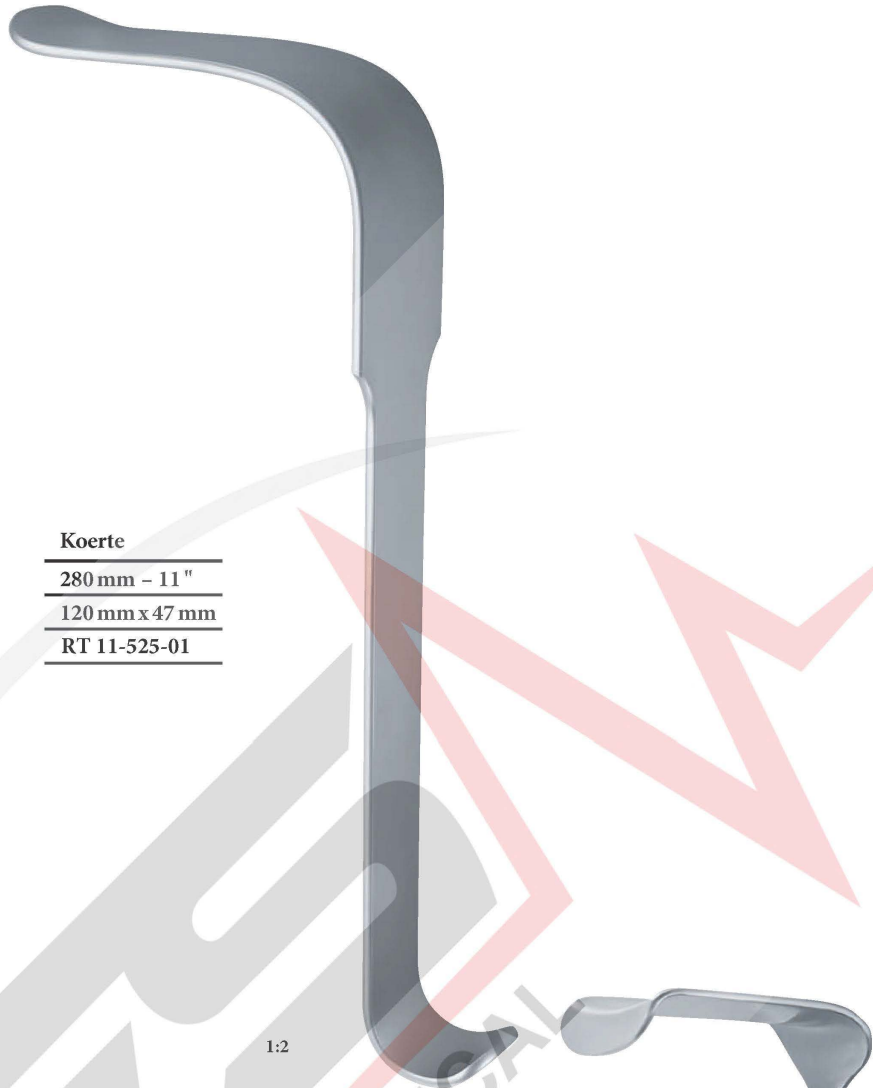

Koerte
280 mm - 11"
120 mm x 47 mm
RT 11-525-01



Tuffier
230 mm - 9"
64 mm x 60 mm
RT 11-526-01



TUDOR-EDWARDS
205 mm, 81/8"
55 x 47 mm
RT 11-527-01

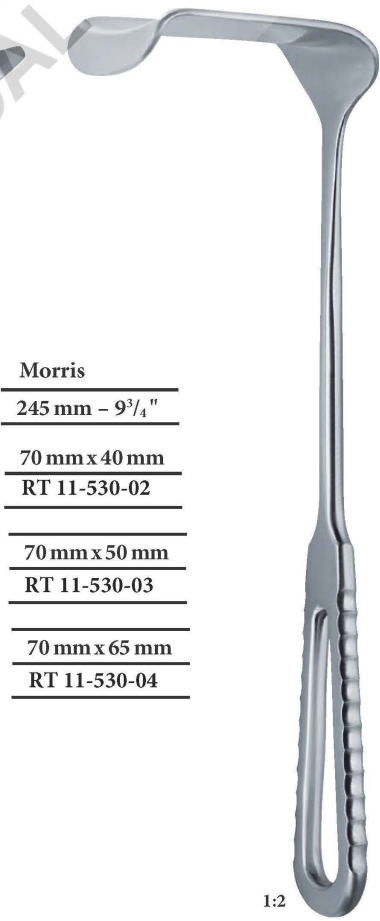

Morris
245 mm - 9³/₄"
70 mm x 40 mm
RT 11-530-02
70 mm x 50 mm
RT 11-530-03
70 mm x 65 mm
RT 11-530-04



Deaver

	x = 25 mm	x = 38 mm	x = 50 mm
315 mm - 12 1/2"	RT 11-535-01	RT 11-535-02	RT 11-535-03

1:3

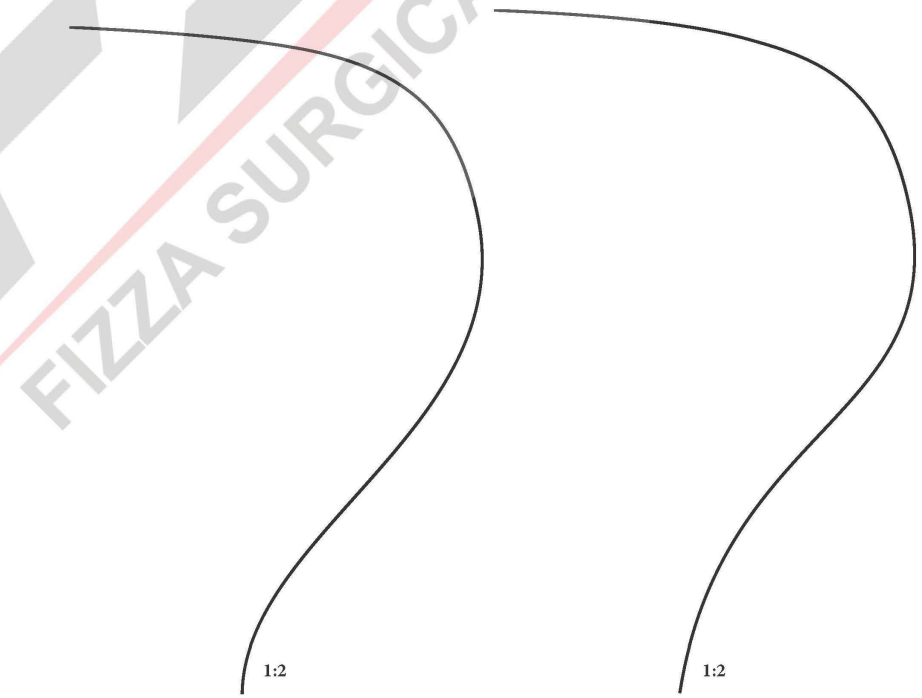
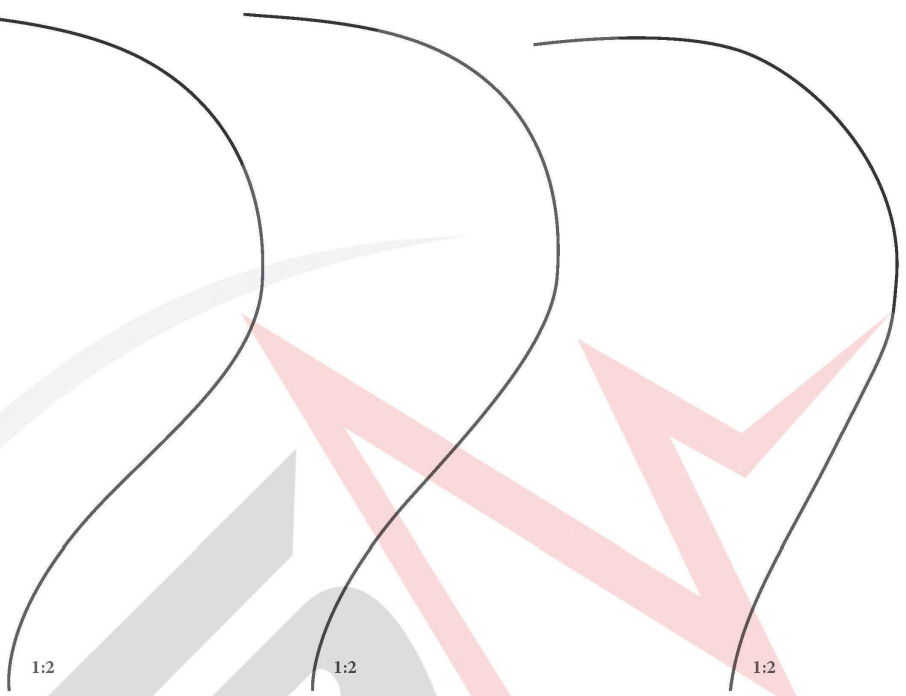

x = 75 mm	x = 100 mm
RT 11-535-04	RT 11-535-05

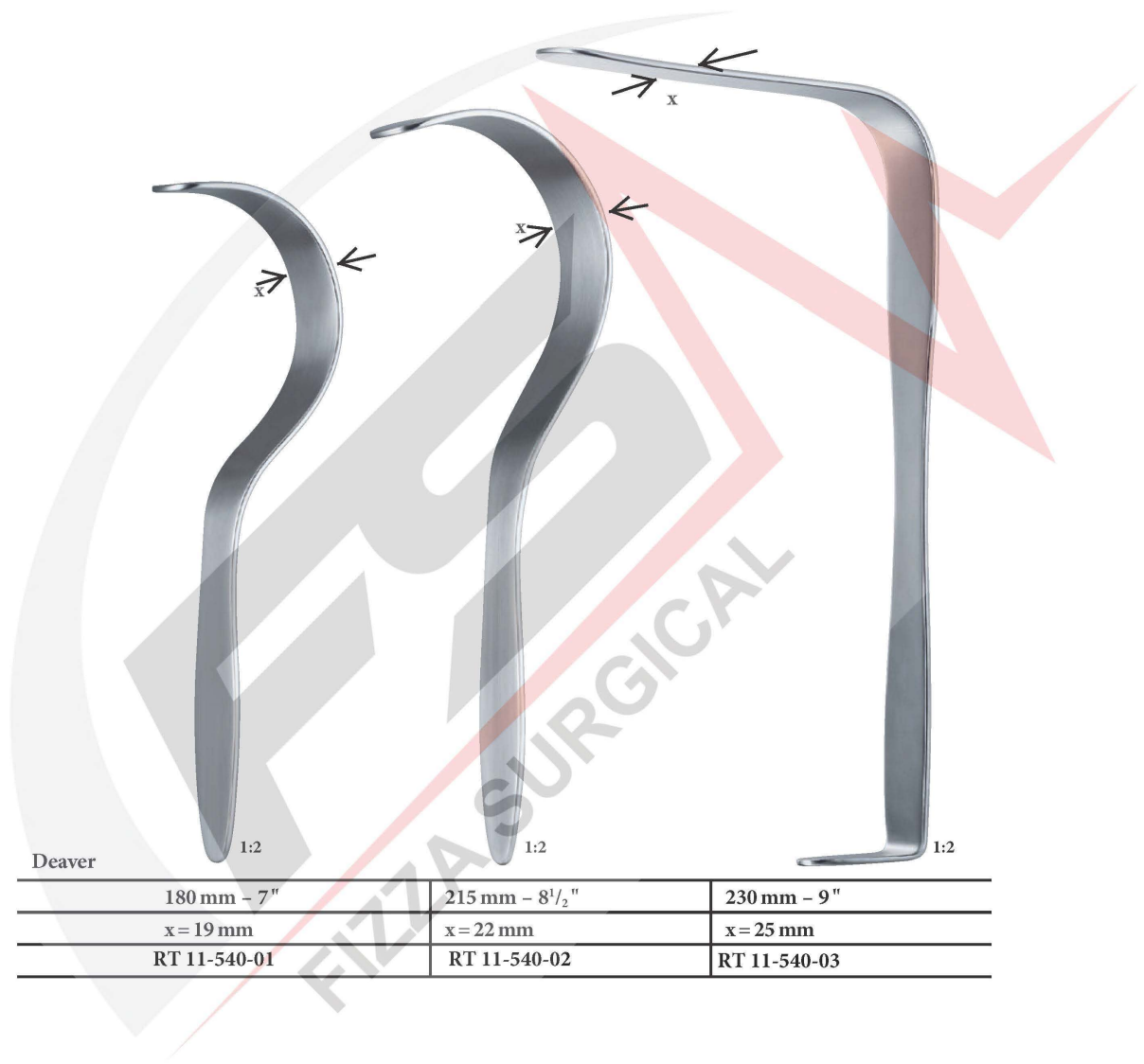

Deaver	180 mm - 7"	215 mm - 8½"	230 mm - 9"
	x = 19 mm	x = 22 mm	x = 25 mm
	RT 11-540-01	RT 11-540-02	RT 11-540-03

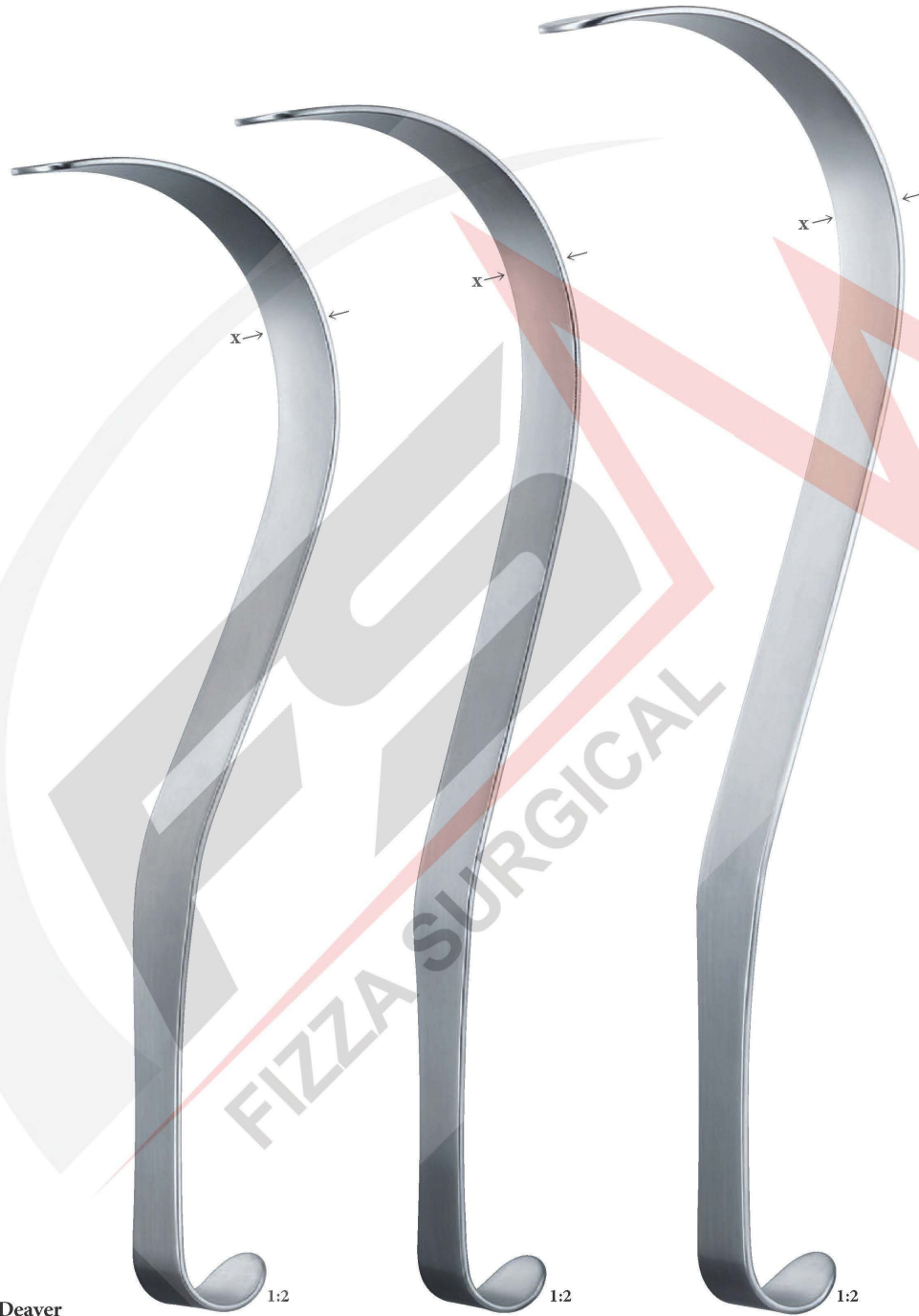

Deaver	1:2	1:2	1:2
	300 mm - 12"	330 mm - 13"	360 mm - 14 ¹ / ₄ "
	x = 25 mm	x = 25 mm	x = 25 mm
	RT 11-540-04	RT 11-540-05	RT 11-540-06



Deaver

1:2

1:2

1:2

300 mm - 12"	300 mm - 12"	300 mm - 12"
x = 38 mm	x = 50 mm	x = 75 mm
RT 11-540-07	RT 11-540-08	RT 11-540-09



Roux			
	Fig. 1	Fig. 2	Fig. 3
	140 mm - 5 ¹ / ₂ "	150 mm - 6"	170 mm - 6 ³ / ₄ "
	24 mm x 20 mm	29 mm x 26 mm	33 mm x 29 mm
	30 mm x 28 mm	36 mm x 36 mm	38 mm x 43 mm
	RT 11-550-01	RT 11-550-02	RT 11-550-03
RT 11-550-00	x	x	x
Set			



Parker		
	Fig. 1	Fig. 2
	135 mm - 5 ¹ / ₄ "	135 mm - 5 ¹ / ₄ "
	18 mm x 15 mm	22 mm x 15 mm
RT 11-555-01	x	x
Set		



GOELET
190 mm, 7¹/₂"
RT 11-556-01



CZERNY
180 mm, 7"
RT 11-557-01



ROUX-MAGNUS
150 mm, 6"
RT 11-558-01
a=20x22 mm b=25x29 mm
170 mm, 6³/₄"
RT 11-558-01
a=25x26 mm b=30x38 mm
170 mm, 6³/₄"
RT 11-558-01
a=28x29 mm b=34x44 mm

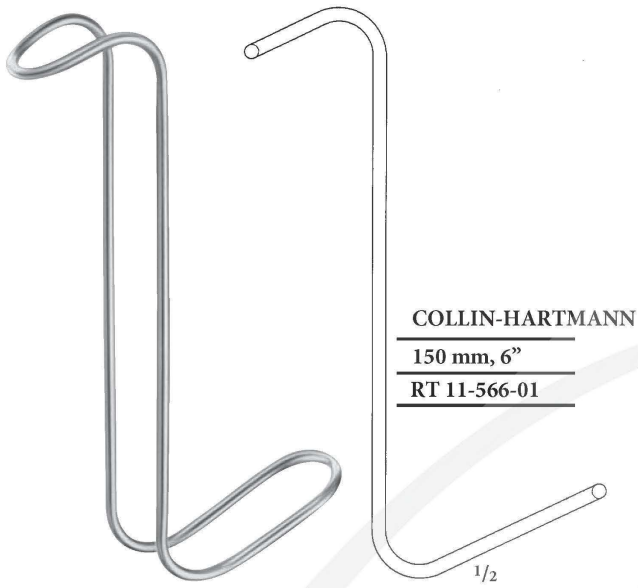

COLLIN-HARTMANN
150 mm, 6"
RT 11-566-01

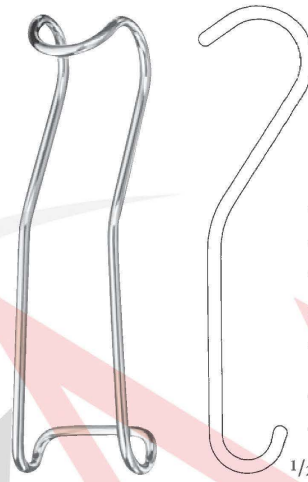

STERNBERG
120 mm 5"
RT 11-567-01
130 mm 4 1/4"
RT 11-567-02
135 mm 5 1/4"
RT 11-567-03

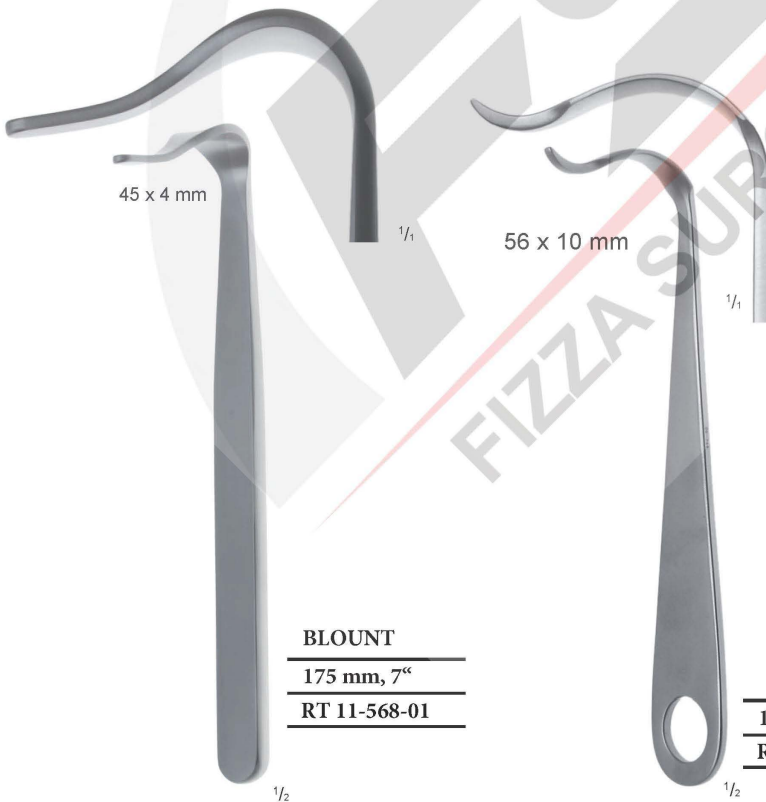

45 x 4 mm

1/1

56 x 10 mm

1/1

BLOUNT

175 mm, 7"

RT 11-568-01

1/2

170 mm, 6 3/4"

RT 11-569-01

1/2

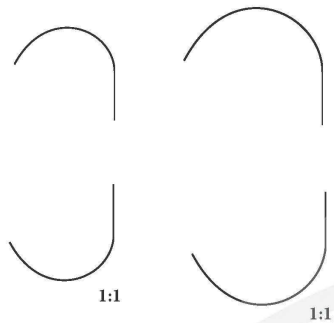

Parker

180 mm - 7"	Fig. 1	Fig. 2
	26 mm x 25 mm	29 mm x 25 mm
	27 mm x 25 mm	27 mm x 25 mm
RT 11-560-01	x	x
Satz		

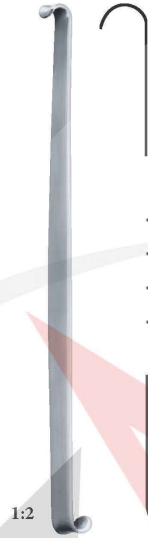

Mini - Roux

145 mm - 5 ³ / ₄ "
8 mm x 6 mm
RT 11-565-01

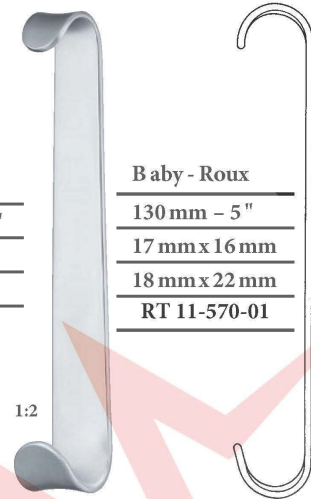

Baby - Roux

130 mm - 5"
17 mm x 16 mm
18 mm x 22 mm
RT 11-570-01

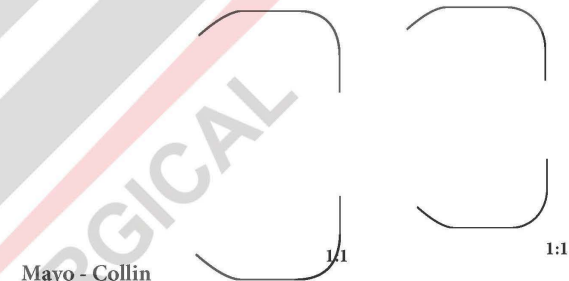

Mayo - Collin

150 mm - 6"	Fig. 1	Fig. 2
	25 mm x 18 mm	28 mm x 19 mm
RT 11-575-01	28 mm x 18 mm	32 mm x 19 mm
	x	x
Set		

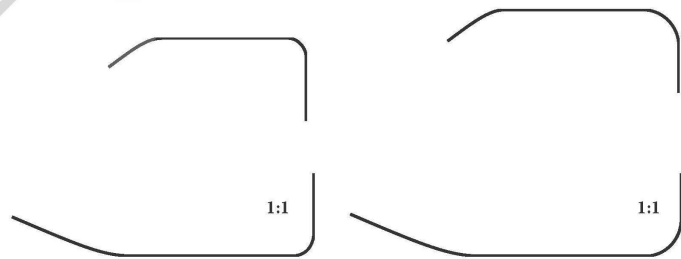

Parker - Langenbeck (US Army)

210 mm - 8 ¹ / ₄ "	Fig. 1	Fig. 2
	21 mm x 24 mm	25 mm x 24 mm
	40 mm x 15 mm	45 mm x 15 mm
RT 11-580-01	x	x
Set		

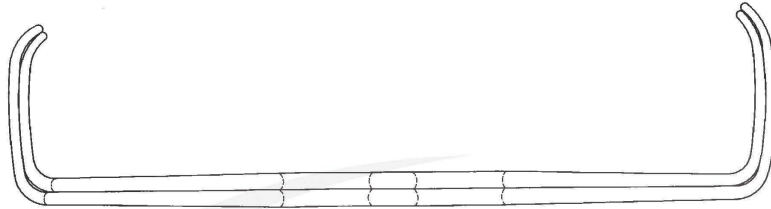

Mathieu

200 mm - 8"	Fig. 1	Fig. 2
	42 mm x 13 mm	47 mm x 13 mm
	42 mm x 26 mm	46 mm x 26 mm
RT 11-585-01	x	x

Set



Farabeuf

120 mm - 4 ³ / ₄ "	Fig. 1	Fig. 2
	26 mm x 10 mm	30 mm x 10 mm
	30 mm x 12 mm	34 mm x 12 mm
RT 11-590-01	x	x

Set



Farabeuf

150 mm - 6"	Fig. 1	Fig. 2
	23 mm x 16 mm	27 mm x 16 mm
	26 mm x 16 mm	30 mm x 16 mm
RT 11-595-01	x	x

Set



Alm

 70 mm - 2³/₄"

 100 mm - 4"

 RT 11-600-01

 RT 11-601-01

Sharp

 RT 11-600-02

 RT 11-601-02

Semi Sharp

 RT 11-600-03

 RT 11-601-03

Blunt



Holtzheimer

 100 mm - 4"

 RT 11-605-01

sharp

 RT 11-605-02

blunt



Bose 1:2

 70 mm - 2³/₄"

 RT 11-610-01



Jansen

 100 mm - 4"

 110 mm - 4¹/₄"

 RT 11-615-01

 RT 11-615-02

sharp

 RT 11-616-01

 RT 11-616-02

blunt



Cloward - Contour

 140 mm - 5¹/₂"

 RT 11-620-01

 3x4

sharp

 RT 11-620-02

 3x4

blunt

Wullstein

 100 mm - 4"

 RT 11-625-01

 3x3 *sharp*

 RT 11-625-02

 3x3 *blunt*



Weitlaner - Wullstein

 130 mm - 5"

 RT 11-630-01

 3x3 *sharp*

 RT 11-630-02

 3x3 *blunt*





Milligan	
130 mm - 5"	RT 11-635-01

3x3 blunt



Belucci		
110 mm - 4 1/4"	RT 11-640-01	RT 11-640-02
130 mm - 5"	RT 11-641-01	RT 11-641-02

1x2 left, blunt



1x2 right, blunt



Mollison	
150 mm - 6"	RT 11-645-01
4x4 sharp	

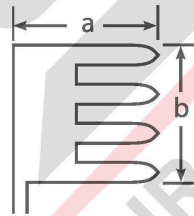

Weitlaner - Loktite

105 mm - 4 1/4"	a=17 mm - b=13 mm	RT 11-650-01	RT 11-651-01	RT 11-652-01	RT 11-653-01	RT 11-654-01	RT 11-655-01
130 mm - 5"	a=17 mm - b=17 mm	RT 11-650-02	RT 11-651-02	RT 11-652-02	RT 11-653-02	RT 11-654-02	RT 11-655-02
165 mm - 6 1/2"	a=17 mm - b=17 mm	RT 11-650-03	RT 11-651-03	RT 11-652-03	RT 11-653-03	RT 11-654-03	RT 11-655-03
200 mm - 8"	a=20 mm - b=19 mm	RT 11-650-04	RT 11-651-04	RT 11-652-04	RT 11-653-04	RT 11-654-04	RT 11-655-04
260 mm - 10 1/4"	a=26 mm - b=21 mm	RT 11-650-05	RT 11-651-05	RT 11-652-05	RT 11-653-05	RT 11-654-05	RT 11-655-05

2x3
sharp

2x3
semi sharp

2x3
blunt

3x4
sharp

3x4
semi sharp

3x4
blunt



1:2

Plester

 130 mm - 5"

 RT 11-660-01

 2x2
blunt

 RT 11-660-02

 2x2
sharp



1:2

Plester

 110 mm - 4 1/4"

 RT 11-665-01

 2x1
left, blunt



1:2

Plester

 RT 11-665-02

 1x2
right, blunt



1:2

Norfolk and Norwich

 220 mm - 8 3/4"

 RT 11-670-01

 4x5
blunt



1:2

Travers

 215 mm - 8 1/2"

 RT 11-676-01

 4x5
blunt

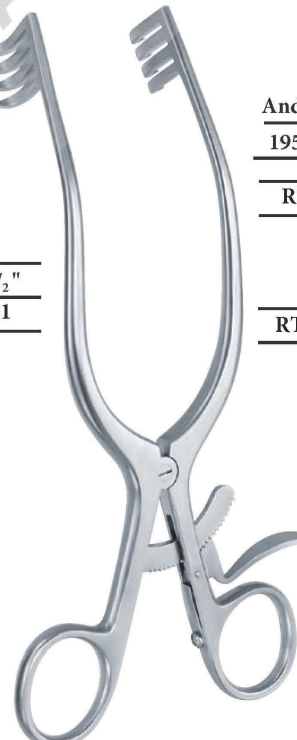

1:2

Anderson - Adson

 195 mm - 7 3/4"

 RT 11-675-01

 4x4
sharp

 RT 11-675-02

 4x4
blunt

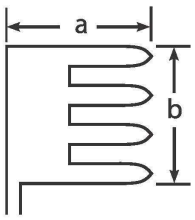

Adson (Cone)

130 mm - 5"	a = 17 mm - b = 19 mm	RT 11-680-01	RT 11-681-01
160 mm - 6 ¹ / ₄ "	a = 17 mm - b = 19 mm	RT 11-680-02	RT 11-681-02
200 mm - 8"	a = 20 mm - b = 20 mm	RT 11-680-03	RT 11-681-03
260 mm - 10 ¹ / ₄ "	a = 26 mm - b = 21 mm	RT 11-680-04	RT 11-681-04

3x4
sharp

3x4
blunt



Beckmann-Eaton

320mm-12¹/₂"
RT 11-685-01

7x7
sharp

1:2



Beckmann

 310 mm - 12¹/₄"

 RT 11-690-01

 4x4
sharp

 RT 11-690-02

 4x4
semi sharp

 RT 11-690-03

 4x4
blunt



Adson

		265 mm - 10 ¹ / ₂ "	265 mm - 10 ¹ / ₂ "
3x4	a = 24 mm - b = 24 mm	RT 11-695-01	RT 11-696-01
6x6	a = 40 mm - b = 40 mm	RT 11-695-02	RT 11-696-02
		<i>sharp</i>	<i>blunt</i>



Beckmann - Adson

310 mm - 12¹/₄"

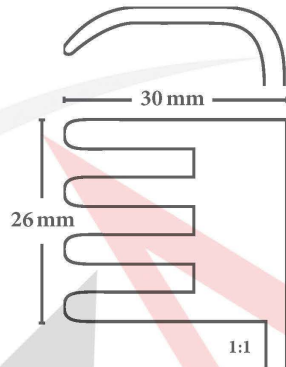

RT 11-700-01

blunt



RT 11-700-02

sharp

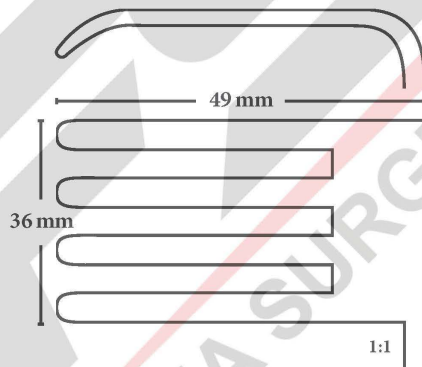

RT 11-705-01

blunt, with deep blades

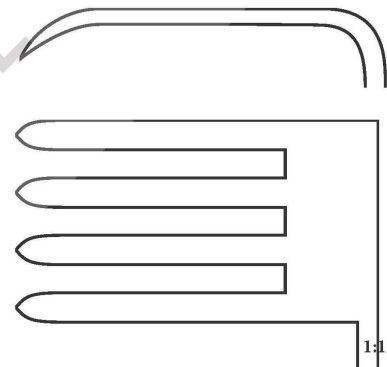

RT 11-705-02

sharp, with deep blades



MARKHAM-MEYERDING

RT 11-701-01

170 mm, 63/4^{cc}

rechts, right: 50 x 100 mm

RT 11-701-02

170 mm, 63/4^{cc}

links, left: 50 x 100 mm

1/2



MARKHAM-MEYERDING

RT 11-702-01

170 mm, 63/4^{cc}

rechts, right : 60 x 100 mm

170 mm, 63/4^{cc}

RT 11-702-02

links, left: 60 x 100 mm

1/2



Carotis

RT 11-703-01

180 mm, 7^{cc}

complete

1/2



MAYO Sperrer

RT 11-704-01

170 mm, 63/4^{cc}

1/2

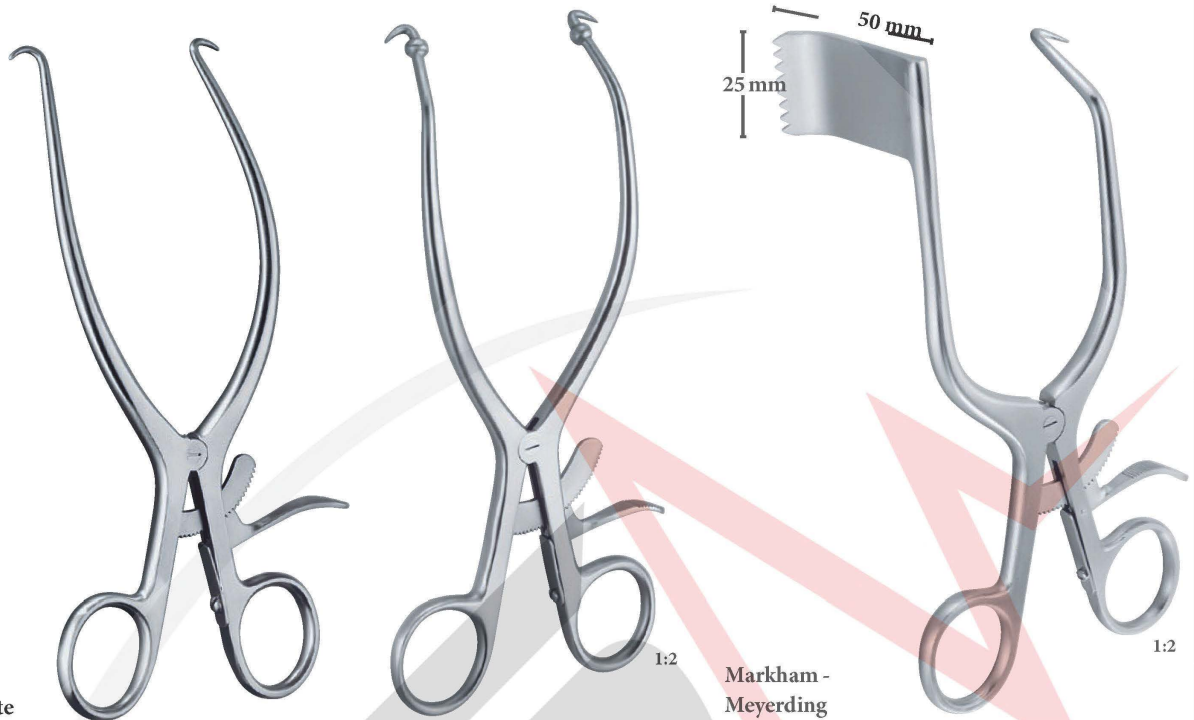

Gelpi - Loktite

Markham - Meyerding

90 mm - 3 1/2"	RT 11-710-01	
110 mm - 4 1/4"	RT 11-710-02	
130 mm - 5"	RT 11-710-03	
180 mm - 7"	RT 11-710-04	RT 11-710-05

180 mm - 7"	RT 11-715-01	RT 11-715-02
	<i>right</i>	<i>left</i>



Rigby

180 mm - 7"
RT 11-720-01



Henley

165 mm - 6 1/2"	RT 11-725-01
-----------------	--------------

3x4
sharp

RT 11-725-02

3x4
blunt

complete with 3 center blades

1:2



19 mm x 16 mm	25 mm x 16 mm	32 mm x 16 mm
RT 11-730-01	RT 11-730-02	RT 11-730-03

Center blades

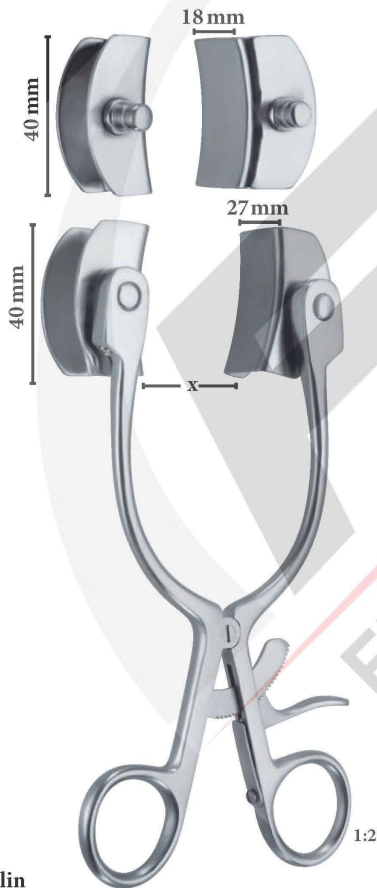

Baby - Collin

180 mm - 7"		
-------------	--	--

x = 80 mm		
-----------	--	--

RT 11-735-01	40 mm x 18 mm	40 mm x 27 mm
--------------	---------------	---------------

complete with 2 pairs of blades



Collin

220 mm - 8 3/4"

x = 100 mm

RT 11-740-01



1:2

Collin

225 mm - 8 ³ / ₄ "		
x = 100 mm		
RT 11-745-01	a = 38 mm - b = 60 mm	a = 38 mm - b = 55 mm
RT 11-745-02	a = 38 mm - b = 80 mm	a = 50 mm - b = 75 mm
RT 11-745-03	a = 37 mm - b = 98 mm	a = 53 mm - b = 76 mm
complete with	Lateral blades	Center blade



1:2

Collin

260 mm - 10 ¹ / ₄ "		
x = 100 mm		
RT 11-750-01	60 mm x 80 mm	60 mm x 75 mm
complete with	Lateral blades	Center blade



1:2

Holzbach

260 mm - 10 ¹ / ₄ "		
x = 100 mm		
RT 11-755-01	62 mm x 80 mm	80 mm x 80 mm
complete with	Lateral blades	Center blade

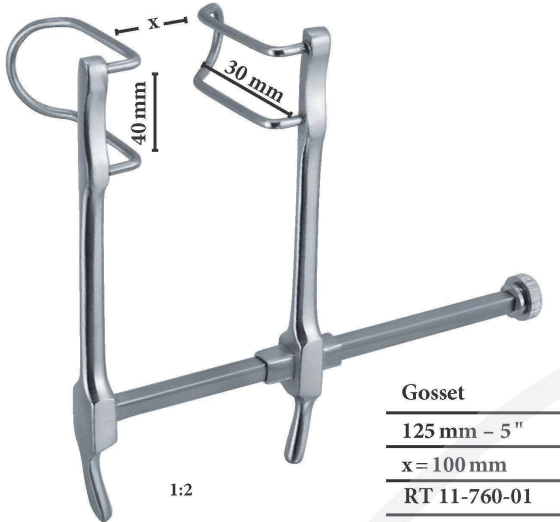

Gosset
125 mm - 5"
x = 100 mm
RT 11-760-01

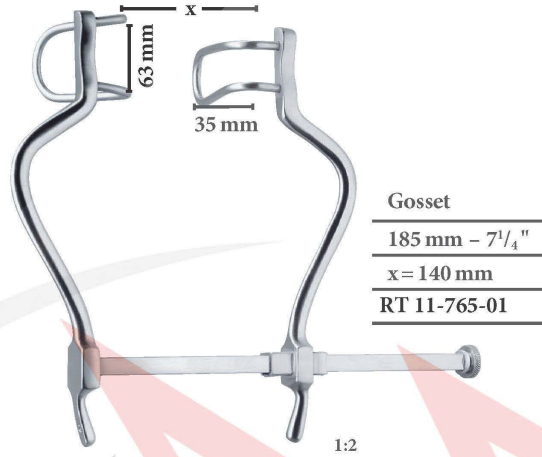

Gosset
185 mm - 7¹/₄"
x = 140 mm
RT 11-765-01

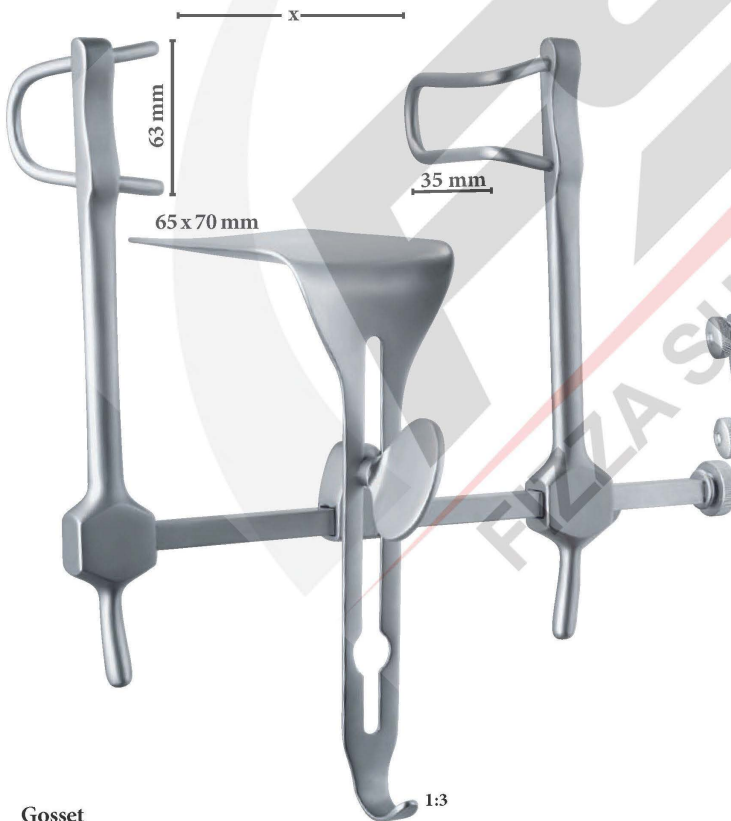

Gosset

x = 160 mm		
RT 11-765-02	35 mm x 63 mm	65 mm x 70 mm
complete with	Lateral blades	Center blade



Balfour

x = 200 mm		
RT 11-770-01	35 mm x 100 mm	70 mm x 100 mm
complete with	Lateral blades	Center blade

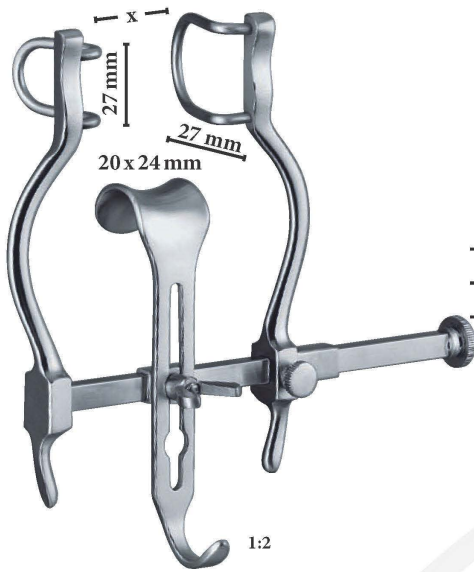

Balfour - Baby

x = 90 mm		
RT 11-775-01	27 mm x 27 mm	20 mm x 24 mm
complete with	Lateral blades	Center blade



Balfour

x = 180 mm		
RT 11-780-01	35 mm x 70 mm	45 mm x 80 mm
complete with	Lateral blades	Center blade
x = 250 mm		
RT 11-780-02	35 mm x 100 mm	70 mm x 85 mm
45 mm x 80 mm	RT 11-780-03	
70 mm x 85 mm	RT 11-780-04	
80 mm x 90 mm	RT 11-780-05	

Center blades, only



Ricard

RT 11-785-01	60 mm x 80 mm	55 mm x 70 mm
complete with	Lateral blades	Center blade
RT 11-785-02	70 mm x 85 mm	80 mm x 90 mm
complete with	Lateral blades	Center blade



O'Sullivan - O'Connor

RT 11-790-01	45 mm x 90 mm	70 mm x 100 mm
complete with	Lateral blades	Center blades

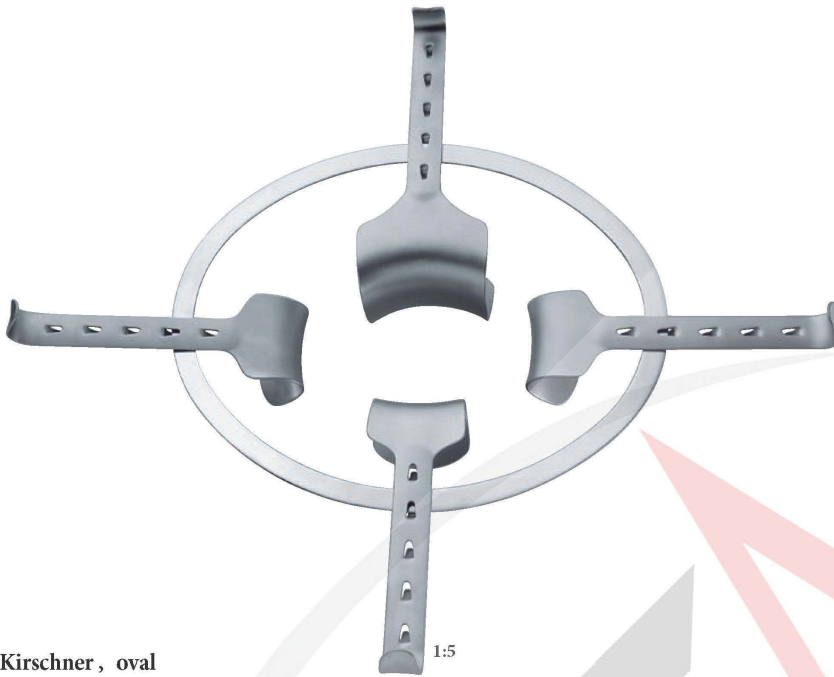

Kirschner , oval

	240 mm x 300 mm	50 mm x 65 mm	80 mm x 90 mm	50 mm x 98 mm	35 mm x 105 mm
	RT 11-791-01	RT 11-791-02	RT 11-791-03	RT 11-791-04	RT 11-791-05
	1 Frame	3 Blades	1 Blade	1 Blade	1 Blade
RT 11-790-00	x	x	x	x	x

Set

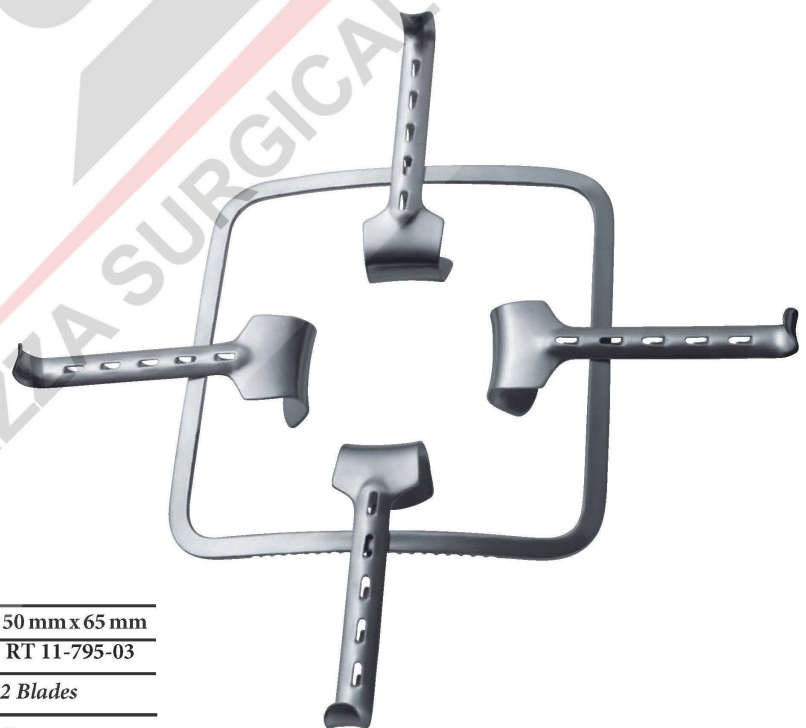

Kirschner

	240 mm x 240 mm	40 mm x 55 mm	50 mm x 65 mm
	RT 11-795-01	RT 11-795-02	RT 11-795-03
	1 Frame, rigid	2 Blades	2 Blades
RT 11-795-00	x	x	x

Set

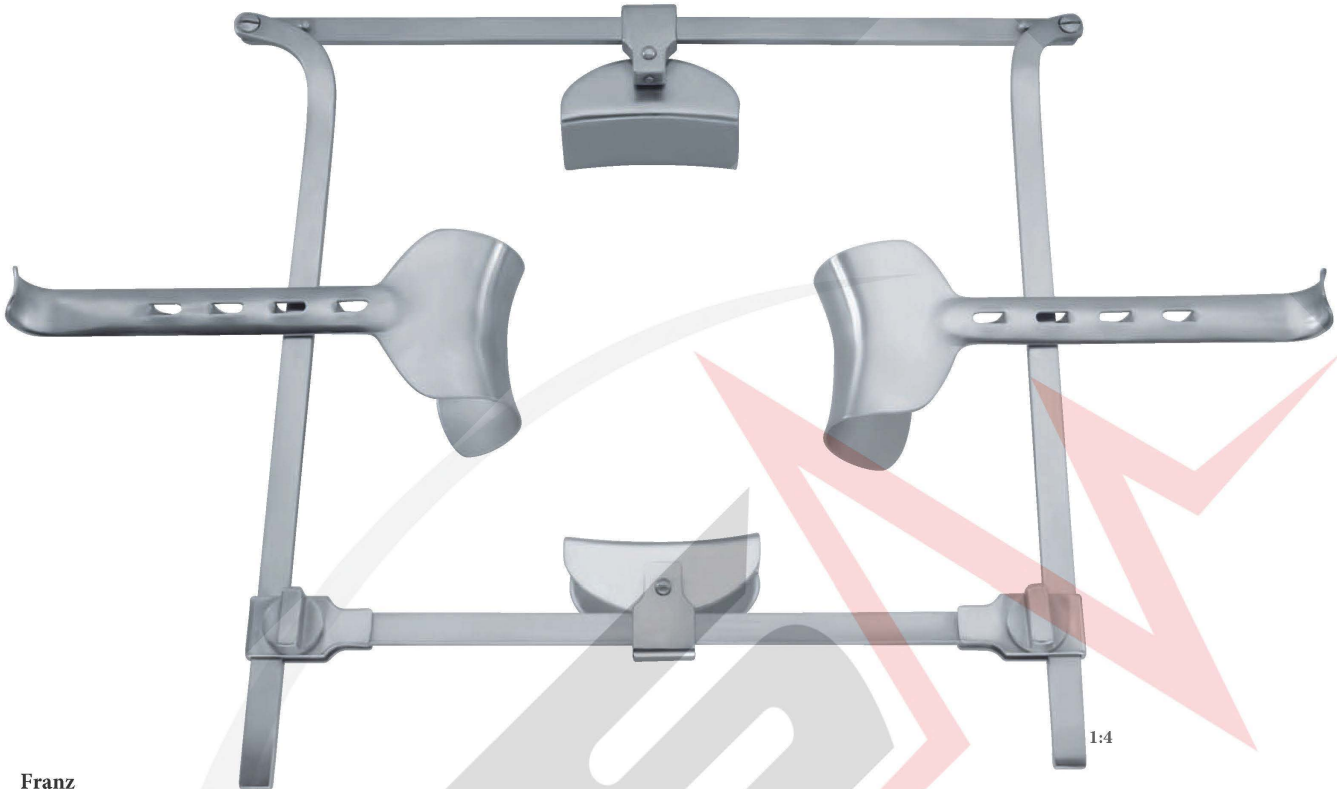

Franz

	300 mm x 300 mm	40 mm x 60 mm	45 mm x 80 mm	50 mm x 65 mm	60 mm x 85 mm
	RT 11-800-01	RT 11-800-02	RT 11-800-03	RT 11-800-04	RT 11-800-05
	1 Frame, foldable	2 Blades	2 Blades	2 Blades	2 Blades
RT 11-800-00	x	x		x	
RT 11-805-01	x	x	x	x	x

Set



Cadre Pliant

Blades for Kirschner- and Franz-frames



40 mm x 60 mm	45 mm x 80 mm	40 mm x 55 mm	50 mm x 65 mm
RT 11-810-01	RT 11-810-02	RT 11-810-02	RT 11-810-03

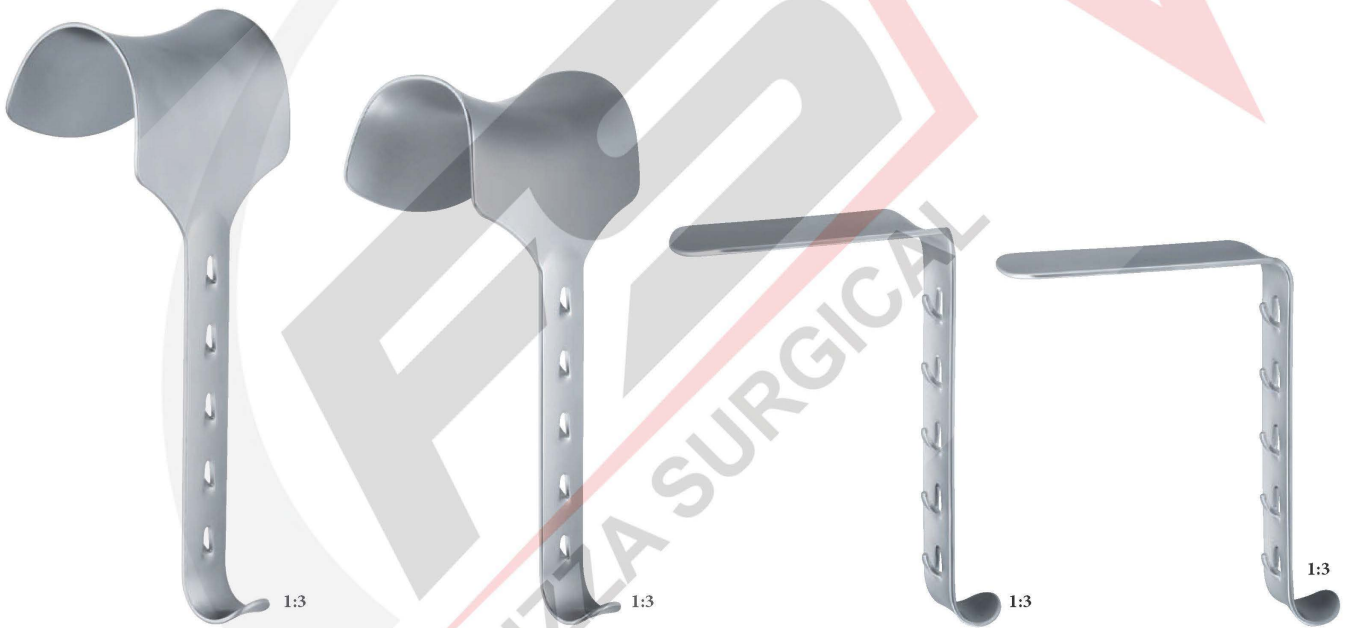

60 mm x 85 mm	80 mm x 90 mm	50 mm x 98 mm	35 mm x 105 mm
RT 11-810-04	RT 11-810-05	RT 11-810-06	RT 11-810-07





	30 mm	40 mm	50 mm
330 mm - 13"	RT 11-815-01	RT 11-815-02	RT 11-815-03

malleable



Martin

200 mm - 8"	200 mm - 8"	250 mm - 9 ³ / ₄ "
12 mm	17 mm	25 mm
RT 11-820-01	RT 11-820-02	RT 11-820-03

soft

	6,5 mm	9,5 mm	13 mm	16 mm	19 mm	25 mm
200 mm - 8"	RT 11-820-04	RT 11-820-05	RT 11-820-06	RT 11-820-07	RT 11-820-08	RT 11-820-09

malleable, very soft



Haberer

200 mm - 8"	280 mm - 11"	300 mm - 12"
17 mm / 25 mm	25 mm / 30 mm	37 mm / 45 mm
RT 11-825-01	RT 11-825-02	RT 11-825-03

malleable



1:2

Reverdin

280 mm - 11"
46 mm x 60 mm
RT 11-821-01



Spatula

145 mm, 5 3/4"
RT 11-831-01





1/2

Allison

255 mm, 10"

RT 11-836-01

Breite, width 40 mm



1/2

Allison

310 mm, 12 1/4"

RT 11-837-01

Breite, width 54 mm



1/2

Allison

300 mm, 12"

RT 11-838-01

Breite, width 130 mm

RT 11-839-01

300 mm, 12"

Breite, width 93 mm

Länge, length 130 mm



O'Sullivan - O'Connor

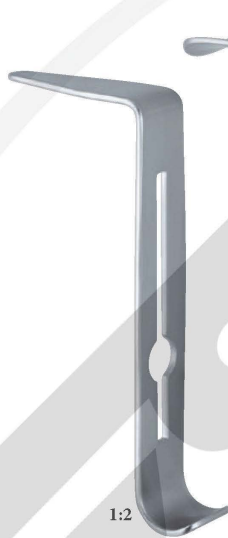
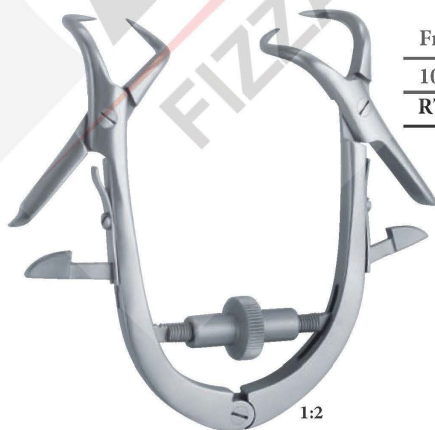

	Fig. 1	Fig. 2	Fig. 3
	45 mm x 17 mm	90 mm x 37 mm	90 mm x 45 mm
	RT 11-830-01	RT 11-830-02	RT 11-830-03
RT 11-830-00	x	x	x

complete



Friedmann

100 mm - 4"

RT 11-835-01



Cloward

160 mm - 6 ¹ / ₄ "	250 mm - 9 ³ / ₄ "
RT 11-840-00	RT 11-845-00

complete with 2 blades ea. Fig. 1 - Fig. 5

complete with 2 blades ea. Fig. 1 - Fig. 5

RT 11-840-01

RT 11-845-01

Retractor without blades

Retractor without blades

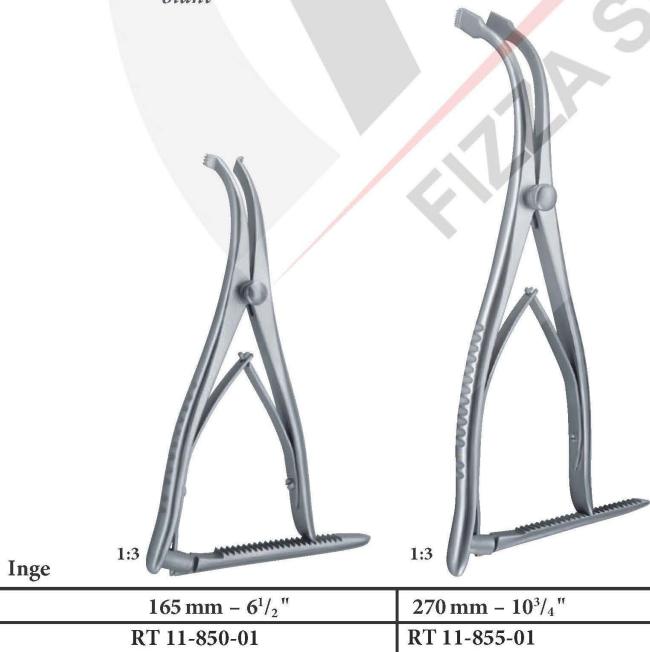

Fig. 1	x = 60 mm	RT 11-840-02
Fig. 2	x = 55 mm	RT 11-840-03
Fig. 3	x = 50 mm	RT 11-840-04
Fig. 4	x = 45 mm	RT 11-840-05
Fig. 5	x = 40 mm	RT 11-840-06

Fig. 1	x = 60 mm	RT 11-845-02
Fig. 2	x = 55 mm	RT 11-845-03
Fig. 3	x = 50 mm	RT 11-845-04
Fig. 4	x = 45 mm	RT 11-845-05
Fig. 5	x = 40 mm	RT 11-845-06

blunt

toothed



**Cloward -
Vertebra**

160 mm - 6 ¹ / ₄ "
RT 11-860-01

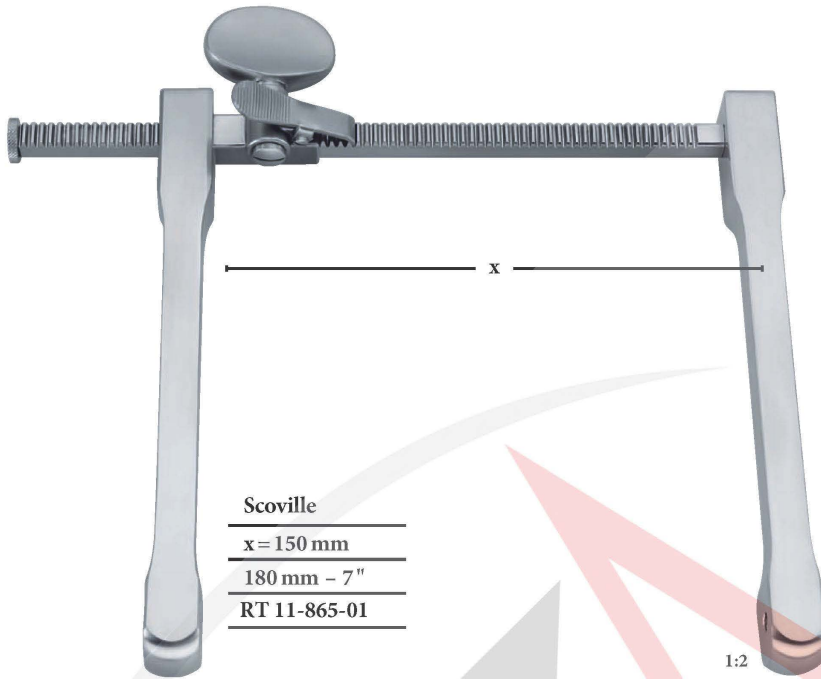

Scoville
 x = 150 mm
 180 mm - 7"
 RT 11-865-01

1:2

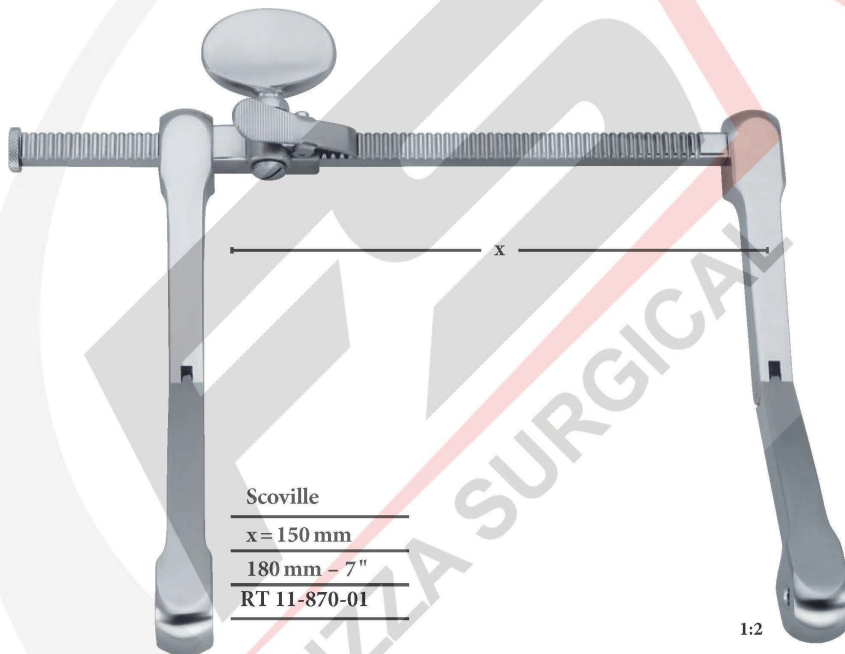

Scoville
 x = 150 mm
 180 mm - 7"
 RT 11-870-01

1:2

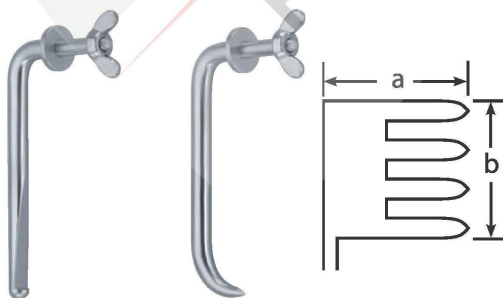

Scoville		
50 mm - 2"	RT 11-874-01	RT 11-873-01
70 mm - 2 ³ / ₄ "	RT 11-874-02	RT 11-873-02

blunt

sharp

Taylor	
a = 48 mm - b = 50 mm - 2" x 2"	RT 11-880-01
a = 63 mm - b = 50 mm - 2 ¹ / ₂ " x 2"	RT 11-880-02
a = 64 mm - b = 64 mm - 3 ¹ / ₄ " x 2 ¹ / ₄ "	RT 11-880-03

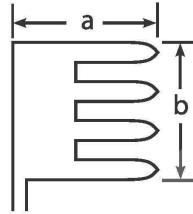

Scoville

a = 40 mm - b = 37 mm - 1 1/2" x 1 1/2"	RT 11-875-03
a = 65 mm - b = 44 mm - 2 1/2" x 1 3/4"	RT 11-875-04



Taylor

a = 100 mm - b = 42 mm - 4" x 1 6/8"	RT 11-880-04
--------------------------------------	--------------



Scoville

a = 57 mm - b = 25 mm - 2 1/4" x 1"	RT 11-875-05
a = 57 mm - b = 38 mm - 2 1/4" x 1 1/2"	RT 11-875-06
a = 64 mm - b = 50 mm - 2 1/2" x 2"	RT 11-875-07
a = 75 mm - b = 25 mm - 3" x 1"	RT 11-875-08



Meyerding

a = 57 mm - b = 25 mm - 2 1/4" x 1"	RT 11-877-01
a = 76 mm - b = 25 mm - 3" x 1"	RT 11-877-02
a = 88 mm - b = 51 mm - 3 1/2" x 2"	RT 11-877-03



Epstein

a = 56 mm - b = 25 mm - 2 1/4" x 1"	RT 11-879-01
-------------------------------------	--------------



Hibbs

a = 50 mm - b = 20 mm - 2" x 3/4"	RT 11-878-01
a = 50 mm - b = 25 mm - 2" x 1"	RT 11-878-02
a = 50 mm - b = 50 mm - 2" x 2"	RT 11-878-03
a = 63 mm - b = 25 mm - 2 1/2" x 1"	RT 11-878-04
a = 63 mm - b = 37 mm - 2 1/2" x 1 1/2"	RT 11-878-05
a = 76 mm - b = 25 mm - 3" x 1"	RT 11-878-06
a = 76 mm - b = 38 mm - 3" x 1 1/2"	RT 11-878-07
a = 76 mm - b = 50 mm - 3" x 2"	RT 11-878-08
a = 76 mm - b = 63 mm - 3" x 2 1/2"	RT 11-878-09
a = 90 mm - b = 25 mm - 3 1/2" x 1"	RT 11-878-10
a = 90 mm - b = 37 mm - 3 1/2" x 1 1/2"	RT 11-878-11
a = 102 mm - b = 25 mm - 4" x 1"	RT 11-878-12
a = 102 mm - b = 50 mm - 4" x 2"	RT 11-878-13

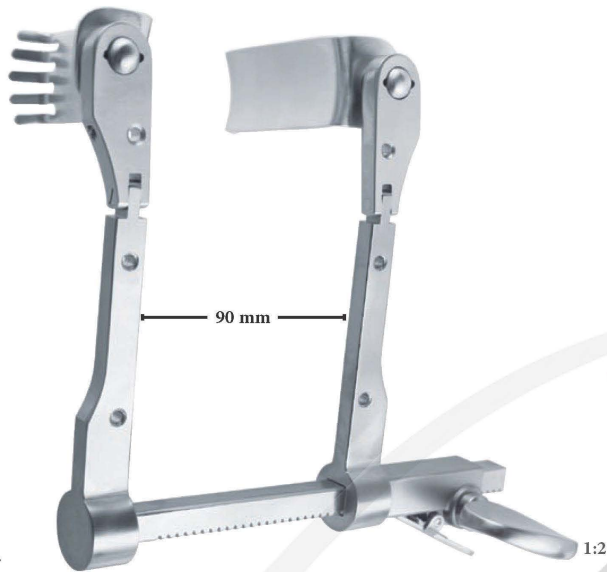

Caspar



1:2

RT11-890-00

RT 11-895-00

complete with 5 medial blades RT 11-890-00 To -05
and with 5 lateral blades RT 11-891-00 To -05

complete with 5 blades RT 11-895-00 To -05

RT 11-891-06

Retractor without blades

RT 11-895-06

Retractor without blades

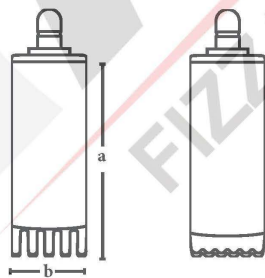

Caspar

Caspar

	medial	lateral
a= 40 mm - b= 23 mm	RT 11-890-01	RT 11-891-01
a= 45 mm - b= 23 mm	RT 11-890-02	RT 11-891-02
a= 50 mm - b= 23 mm	RT 11-890-03	RT 11-891-03
a= 55 mm - b= 23 mm	RT 11-890-04	RT 11-891-04
a= 60 mm - b= 23 mm	RT 11-890-05	RT 11-891-05

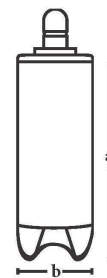

a= 45 mm - b= 23 mm	RT 11-895-01
a= 50 mm - b= 23 mm	RT 11-895-02
a= 55 mm - b= 23 mm	RT 11-895-03
a= 60 mm - b= 23 mm	RT 11-895-04
a= 65 mm - b= 23 mm	RT 11-895-05

blunt



Caspar

RT 11-900-01

complete with 6 blades RT 11-900-02 To -09

RT 11-900-00

Retractor without blades



RT 11-905-01

complete with 5 blades RT 11-905-02 To 09

RT 11-905-00

Retractor only, with key

RT 11-910-01

Key



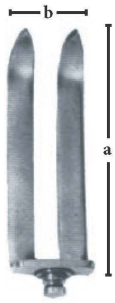

a= 35 mm - b= 22 mm	RT 11-900-02
a= 40 mm - b= 22 mm	RT 11-900-03
a= 45 mm - b= 22 mm	RT 11-900-04
a= 50 mm - b= 22 mm	RT 11-900-05
a= 55 mm - b= 22 mm	RT 11-900-06
a= 60 mm - b= 22 mm	RT 11-900-07
a= 65 mm - b= 22 mm	RT 11-900-08
a= 70 mm - b= 22 mm	RT 11-900-09

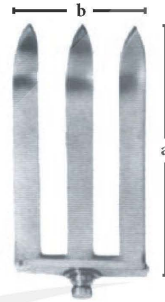

a= 35 mm - b= 37 mm	RT 11-901-02
a= 40 mm - b= 37 mm	RT 11-901-03
a= 45 mm - b= 37 mm	RT 11-901-04
a= 50 mm - b= 37 mm	RT 11-901-05
a= 55 mm - b= 37 mm	RT 11-901-06
a= 60 mm - b= 37 mm	RT 11-901-07
a= 65 mm - b= 37 mm	RT 11-901-08
a= 70 mm - b= 37 mm	RT 11-901-09

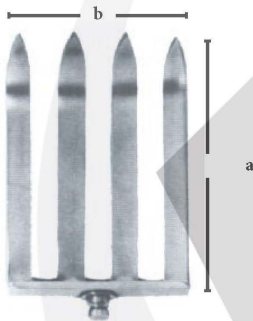

a= 35 mm - b= 52 mm	RT 11-902-02
a= 40 mm - b= 52 mm	RT 11-902-03
a= 45 mm - b= 52 mm	RT 11-902-04
a= 50 mm - b= 52 mm	RT 11-902-05
a= 55 mm - b= 52 mm	RT 11-902-06
a= 60 mm - b= 52 mm	RT 11-902-07
a= 65 mm - b= 52 mm	RT 11-902-08
a= 70 mm - b= 52 mm	RT 11-902-09



Caspar

38 mm	58 mm
RT 11-903-01	RT 11-903-02



Caspar

a = 40 mm	RT 11-915-01
a = 45 mm	RT 11-915-02
a = 50 mm	RT 11-915-03
a = 55 mm	RT 11-915-04
a = 60 mm	RT 11-915-05
a = 65 mm	RT 11-915-06
a = 75 mm	RT 11-915-07
a = 85 mm	



Caspar

RT 11-920-00



Caspar

a = 35 mm	RT 11-920-01	RT 11-921-01
a = 40 mm	RT 11-920-02	RT 11-921-02
a = 45 mm	RT 11-920-03	RT 11-921-03
a = 50 mm	RT 11-920-04	RT 11-921-04
a = 55 mm	RT 11-920-05	RT 11-921-05
a = 60 mm	RT 11-920-06	RT 11-921-06
a = 65 mm	RT 11-920-07	RT 11-921-07
a = 70 mm	RT 11-920-08	RT 11-921-08
a = 75 mm	RT 11-920-09	RT 11-921-09
a = 85 mm	RT 11-920-10	RT 11-921-10

Speculum for hypophysectomy



x = 70 mm	RT11-925-01
x = 90 mm	RT11-925-02
x = 110 mm	RT11-925-03

Speculum for trans-sphenoidal hypophysectomy