



# *SCHEREN – SCISSORS*

*By*

Fizza Surgical International





## COMPANY PROFILE

Company name : FIZZA SURGICAL INTERNATIONAL  
Company address : NARGATE STREET, JINNAH PARK , COLONY #2,,  
Sialkot – 51310 Pakistan  
PHONE : +92-52-460 4164  
FAX : +92-52-458 0014  
E-MAIL : info@fizzasurgical.com  
Web site : www.fizzasurgical.com

PERSON TO CONTACT : NAJAF ALI  
DESIGNATION : Managing Director  
info@fizzasurgical.com

PERSON TO CONTACT : NAJAM ALI  
DESIGNATION : Export  
Najam.Ali@fizzasurgical.com

PERSON TO CONTACT : ALI HASSAN  
DESIGNATION : Sales & Markeeting  
Ali.Hassan@fizzasurgical.com

Products manufacture: GYNECOLOGY INSTRUMENTS, ALL TYPE OF SCISSORS,  
RFORCEPS AND ETRACTORS etc.

O.E.M. We can produce any type of vaginal speculums, retractors, dilators  
Forceps, Scissors etc.  
Also on O.E.M. basis if the drawings or Master samples are  
provided To us by the customer.

Areas of Exports : Germany, France, Japan, U.K. etc.

CERTIFICATION : ISO 9001 : 2008  
ISO 13485 : 2003  
CE CERTIFICATION BY MHRA – UK  
EC DECLARATION OF CONFORMITY





QUALITY POLICY : CUSTOMER'S SATISFACTION

MISSION STATEMENT : TO BECOME TOP MOST MEDICAL COMPANY IN PAKISTAN

Brief History of the company: Fizza Surgical International has made revolutionary changes in its manufacturing procedures from hand-made to modern machinery during the last 3 decades. Highly skilled workers are Proficiently working on these machinery multiplying production figures on one hand and having improved the quality of products to entire satisfaction of the customers.

Materials used in production : The materials used in production of these medical instruments conform to internationally recognized standards; viz. Grade AISI-410, Grade AISI-420 and Grade AISI-304. We use Japanese, German and French stainless steels.



Standard	Blunt/Blunt	Sharp/Blunt	Sharp/Sharp
	Fig. 1	Fig. 2	Fig. 3
105 mm – 4 1/4"	SC02-10-01	SC02-11-01	SC02-12-01
115 mm – 4 1/2"	SC02-10-02	SC02-11-02	SC02-12-02
130 mm – 5"	SC02-10-03	SC02-11-03	SC02-12-03
145 mm – 5 3/4"	SC02-10-04	SC02-11-04	SC02-12-04
155 mm – 6"	SC02-10-05	SC02-11-05	SC02-12-05
165 mm – 6 1/2"	SC02-10-06	SC02-11-06	SC02-12-06
175 mm – 7"	SC02-10-07	SC02-11-07	SC02-12-07
185 mm – 7 1/4"	SC02-10-08	SC02-11-08	SC02-12-08
200 mm – 8"	SC02-10-09	SC02-11-09	SC02-12-09



Standard	Blunt/Blunt	Sharp/Blunt	Sharp/Sharp
	Fig. 1	Fig. 2	Fig. 3
115 mm – 4 1/2"	SC02-15-01	SC02-16-01	SC02-17-01
130 mm – 5"	SC02-15-02	SC02-16-02	SC02-17-02
145 mm – 5 3/4"	SC02-15-03	SC02-16-03	SC02-17-03
155 mm – 6"	SC02-15-04	SC02-16-04	SC02-17-04
165 mm – 6 1/2"	SC02-15-05	SC02-16-05	SC02-17-05
175 mm – 7"	SC02-15-06	SC02-16-06	SC02-17-06
185 mm – 7 1/4"	SC02-15-07	SC02-16-07	SC02-17-07
200 mm – 8"	SC02-15-08	SC02-16-08	SC02-17-08



Graziol	Blunt/Blunt	Sharp/Blunt	Sharp/Sharp
	Fig. 1	Fig. 2	Fig. 3
130 mm – 5"	SC02-20-01	SC02-21-01	SC02-22-01
145 mm – 5 3/4"	SC02-20-02	SC02-21-02	SC02-22-02



Graziol	Blunt/Blunt	Sharp/Blunt	Sharp/Sharp
	Fig. 1	Fig. 2	Fig. 3
130 mm - 5"	SC02-25-01	SC02-26-01	SC02-27-01
145 mm - 5 <sup>3</sup> / <sub>4</sub> "	SC02-25-02	SC02-26-02	SC02-27-02



Deaver	Sharp/Blunt	Sharp/Blunt	Sharp/Blunt	Sharp/Blunt
145 mm - 5 <sup>3</sup> / <sub>4</sub> "	SC02-30-01	SC02-31-01	SC02-32-01	SC02-33-01
	<i>straight</i>	<i>curved</i>	<i>straight, Serrated Blade</i>	<i>curved, Serrated Blade</i>



Lange	Sharp/Blunt	Sharp/Blunt	Sharp/Blunt	Sharp/Blunt
145 mm - 5 <sup>3</sup> / <sub>4</sub> "	SC02-35-01	SC02-36-01	SC02-37-01	SC02-38-01
	<i>straight</i>	<i>curved</i>	<i>straight, Serrated Blade</i>	<i>curved, Serrated Blade</i>



Mixer

155 mm - 6"



1:2

straight

SC02-40-01

straight, saw edge

SC02-40-02



1:2

curved

SC02-41-01

curved, Serrated Blade

SC02-41-02



Lexer

160 mm - 6<sup>1</sup>/<sub>4</sub>"

SC02-45-01

SC02-46-01

210 mm - 8<sup>1</sup>/<sub>4</sub>"

SC02-45-02

SC02-46-02



Fergusson

140 mm - 5<sup>1</sup>/<sub>2</sub>"

SC02-55-01

160 mm - 6<sup>1</sup>/<sub>4</sub>"

SC02-55-03

180 mm - 7"

SC02-55-03



Richter

140 mm - 5<sup>1</sup>/<sub>2</sub>"

SC02-50-01

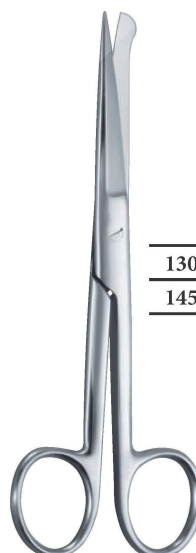

130 mm - 5"

SC02-60-01

145 mm - 5<sup>3</sup>/<sub>4</sub>"

SC02-60-02



Mayo

145 mm - 5 <sup>3</sup> / <sub>4</sub> "	SC02-65-01	SC02-66-01
150 mm - 6"	SC02-65-02	SC02-66-02
170 mm - 6 <sup>3</sup> / <sub>4</sub> "	SC02-65-03	SC02-66-03
230 mm - 9"	SC02-65-04	SC02-66-04



Mayo - Stille

150 mm - 6"	SC02-70-01	SC02-71-01
170 mm - 6 <sup>3</sup> / <sub>4</sub> "	SC02-70-02	SC02-71-02
195 mm - 7 <sup>3</sup> / <sub>4</sub> "	SC02-70-03	SC02-71-03
210 mm - 8 <sup>3</sup> / <sub>4</sub> "	SC02-70-04	SC02-71-04



Mayo - Harrington

220 mm - 8 <sup>3</sup> / <sub>4</sub> "	SC02-75-01	SC02-76-01
--	------------	------------



1:2



*Operating scissors – Dissecting scissors*



**Mayo - Noble**

170 mm – 6 <sup>3</sup> / <sub>4</sub> "	SC 02-80-01	SC 02-81-01
--	-------------	-------------

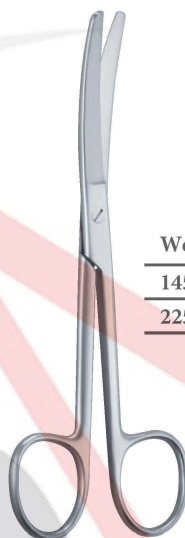

**Wertheim**

145 mm – 5 <sup>3</sup> / <sub>4</sub> "	SC 02-85-01
225 mm – 8 <sup>3</sup> / <sub>4</sub> "	SC 02-85-02



**Metzenbaum**



	Fig. 1	Fig. 2	Fig. 3
115 mm – 4 <sup>1</sup> / <sub>2</sub> "	SC 02-95-01	SC 02-96-01	SC 02-97-01
145 mm – 5 <sup>3</sup> / <sub>4</sub> "	SC 02-95-02	SC 02-96-02	SC 02-97-02

**Metzenbaum**



150 mm – 6"	SC 02-90-01	SC 02-91-01
-------------	-------------	-------------

**Operating scissors – Dissecting scissors**





Metzenbaum			
	Fig. 1	Fig. 2	Fig. 3
115 mm – 4 1/2"	SC 02-100-01	SC 02-101-01	SC 02-101-01
145 mm – 5 3/4"	SC 02-100-02	SC 02-101-02	SC 02-101-02



Metzenbaum-Nelson			
	Fig. 1	Fig. 2	Fig. 3
180 mm – 7"	SC 02-105-01	SC 02-106-01	SC 02-107-01
200 mm – 8"	SC 02-105-02	SC 02-106-02	SC 02-107-02
230 mm – 9"	SC 02-105-03	SC 02-106-03	SC 02-107-03
250 mm – 9 3/4"	SC 02-105-04	SC 02-106-04	SC 02-107-04
280 mm – 11"	SC 02-105-05	SC 02-106-05	SC 02-107-05
300 mm – 12"	SC 02-105-06	SC 02-106-06	SC 02-107-06







Metzenbaum-Nelson			
	Fig. 1	Fig. 2	Fig. 3
180 mm – 7"	SC 02-110-01	SC 02-111-01	SC 02-112-01
200 mm – 8"	SC 02-110-02	SC 02-111-02	SC 02-112-02
230 mm – 9"	SC 02-110-03	SC 02-111-03	SC 02-112-03
250 mm – 9 3/4"	SC 02-110-04	SC 02-111-04	SC 02-112-04
280 mm – 11"	SC 02-110-05	SC 02-111-05	SC 02-112-05
300 mm – 12"	SC 02-110-06	SC 02-111-06	SC 02-112-06



**Chirurgische Scheren – Präparierscheren**  
**Operating scissors – Dissecting scissors**



**Metzenbaum-Fino**

	 1:2	 1:2	 1:2	 1:2
	Fig. 1	Fig. 3	Fig. 1	Fig. 3
145 mm – 5 <sup>3</sup> / <sub>4</sub> "	SC 02-115-01	SC 02-116-01	SC 02-117-01	SC 02-118-01



**FOMON**

135 mm – 5<sup>1</sup>/<sub>4</sub>"  
SC 02-125-01



**Metzenbaum-Fino**

180 mm – 7"	SC 02-120-01	SC 02-121-01	SC 02-122-01
220 mm – 8"	SC 02-120-02	SC 02-121-02	SC 02-122-02
230 mm – 9"	SC 02-120-03	SC 02-121-03	SC 02-122-03

S-förmig gebogen  
S-curved



**Thorek**

190 mm – 7<sup>1</sup>/<sub>2</sub>"  
SC 02-130-01

**SCHEREN – SCISSORS**

*Gynaecological scissors*

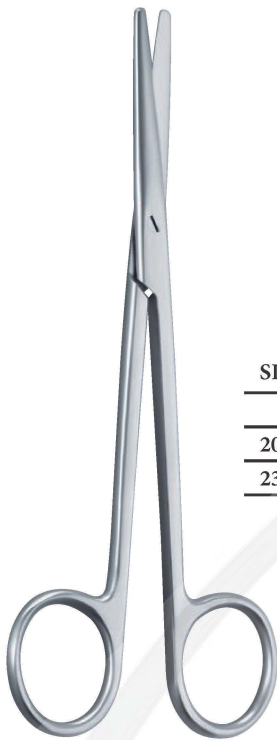

SIMS

	Fig. 1	Fig. 2	Fig. 1	Fig. 2
200 mm – 8"	SC 02-135-01	SC 02-136-01	SC 02-137-01	SC 02-138-01
230 mm – 9"	SC 02-135-02	SC 02-136-02	SC 02-137-02	SC 02-138-02



DUBOIS

270 mm – 10 <sup>3</sup> / <sub>4</sub> "	SC 02-140-01
---	--------------



SC 02-141-01



DOYEN

175 mm – 7"



SC 02-145-01

SC 02-146-01



SIEBOLD

240 mm – 9<sup>1</sup>/<sub>2</sub>"

SC 02-150-01

S-CURVED



1:2

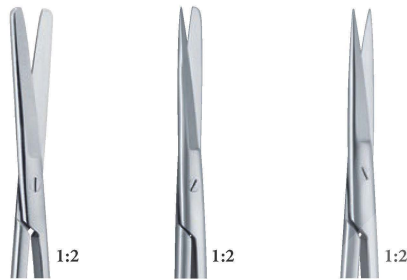

1:2

1:2

1:2

	Fig. 1	Fig. 2	Fig. 3
120 mm – 4 <sup>3</sup> / <sub>4</sub> "	SC 02-155-01	SC 02-156-01	SC 02-157-01



1:2



1:2

1:2

1:2

	Fig. 1	Fig. 2	Fig. 3
120 mm – 4 <sup>3</sup> / <sub>4</sub> "	SC 02-160-01	SC 02-161-01	SC 02-162-01



1:2



1:2

Brophy (Sullivan)	
145 mm – 5 <sup>3</sup> / <sub>4</sub> "	SC 02-175-01



1:2

SC 02-176-01
--------------



1:2

**Knapp**



1:2

1:2

105 mm – 4 <sup>1</sup> / <sub>4</sub> "	SC 02-165-01	SC 02-166-01
--	--------------	--------------

*blunt*



**Littler**



115 mm – 4 <sup>1</sup> / <sub>2</sub> "	SC 02-180-01
145 mm – 5 <sup>3</sup> / <sub>4</sub> "	SC 02-180-02



1:2

**Wagner**



1:2

1:2

120 mm – 4 <sup>3</sup> / <sub>4</sub> "	SC 02-170-01	SC 02-170-02	SC 02-171-01	SC 02-171-02
--	--------------	--------------	--------------	--------------

*straight*

*straight, Serrated Blade curved*

*curved, Serrated Blade*

*Fine scissors*



**Locklin**

165 mm - 6 1/2"

SC 02-185-01



SC 02-186-01



**Quinby**

125 mm - 5"

SC 02-190-01

*Serrated Blade,*



**Reynolds**

160 mm - 6 1/4"

SC 02-195-01

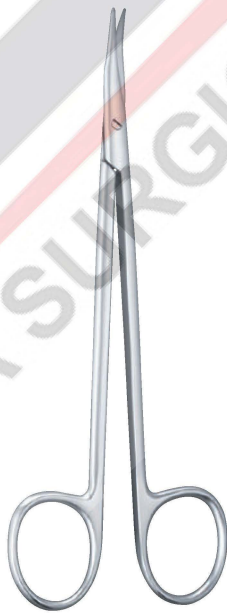

SC 02-196-01

180 mm - 7"

SC 02-195-02

SC 02-196-02



**Neumann**

120 mm - 4 3/4"

SC 02-200-01

*S-curved*

*Fine scissors*

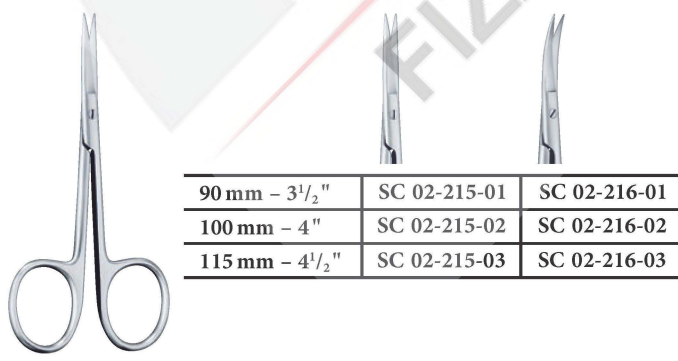
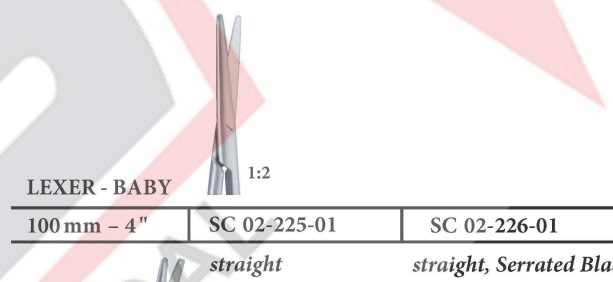
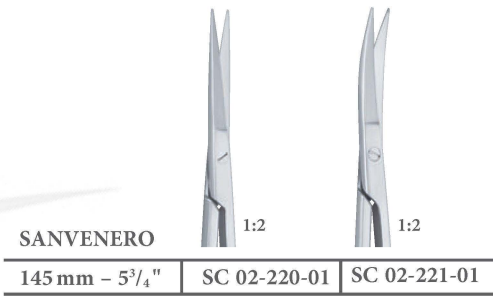
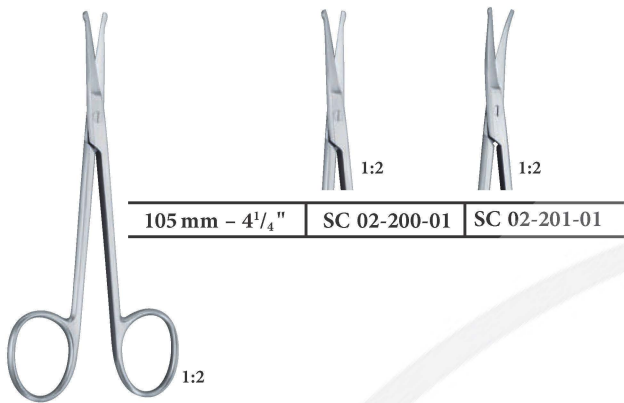



*Fistula scissors*

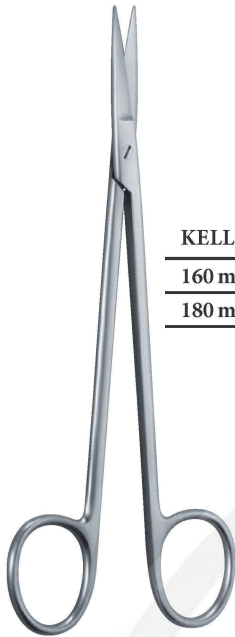

**KELLY**

160 mm - 6 <sup>1</sup> / <sub>4</sub> "	SC 02-235-01	SC 02-236-01
180 mm - 7"	SC 02-235-02	SC 02-236-02



**Enukleationsscheren Enucleation scissors**



**LANDOLDT**

125 mm - 5"	SC 02-240-01	SC 02-241-01
-------------	--------------	--------------

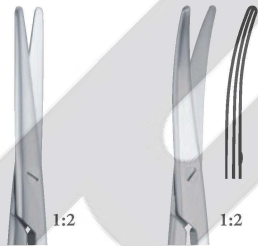

110 mm - 4 <sup>1</sup> / <sub>4</sub> "	SC 02-245-01
--	--------------

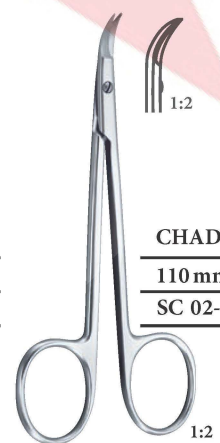

**CHADWICK**

110 mm - 4 <sup>1</sup> / <sub>4</sub> "	SC 02-250-01
--	--------------



**JOSEPH**

140 mm - 5 <sup>1</sup> / <sub>2</sub> "	SC 02-255-01	SC 02-256-01
--	--------------	--------------



**KILNER (Ragnell)**

120 mm - 4 <sup>3</sup> / <sub>4</sub> "	SC 02-260-01
150 mm - 6"	SC 02-260-02



*Plastic surgery scissors*



**Gorney**  

200 mm - 8"	SC 02-265-01	SC 02-266-01
-------------	--------------	--------------

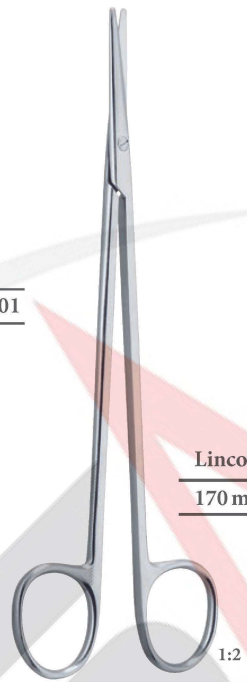
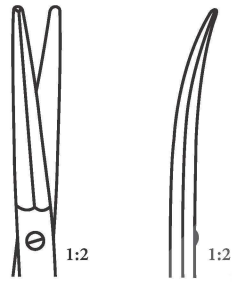

**Lincoln**  

170 mm - 6 <sup>3</sup> / <sub>4</sub> "	SC 02-275-01	SC 02-276-01
--	--------------	--------------



145 mm - 5<sup>3</sup>/<sub>4</sub>"  
 SC 02-270-01

*1 Blade with probe*



115 mm - 4<sup>1</sup>/<sub>2</sub>"  
 SC 02-280-01

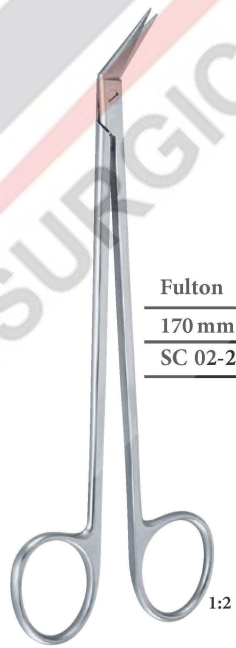

**Fulton**  

170 mm - 6 <sup>3</sup> / <sub>4</sub> "
SC 02-285-01

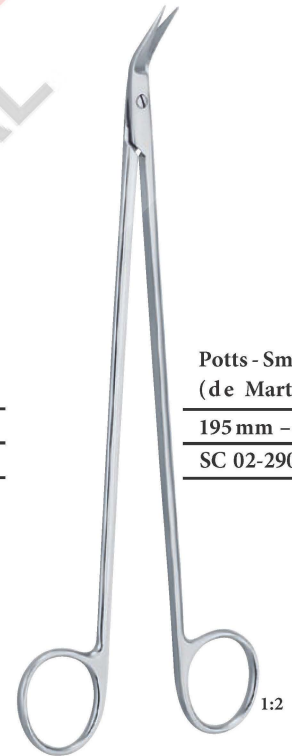

**Potts - Smith  
(de Martel)**  

195 mm - 7 <sup>3</sup> / <sub>4</sub> "
SC 02-290-01



*Artery scissors*



**Favaloro**  
150 mm – 6"  
SC 02-295-01



**De Bakey**  
155 mm – 6" SC 02-300-01 SC 02-301-01  
*Offset scissors, s-shaped*

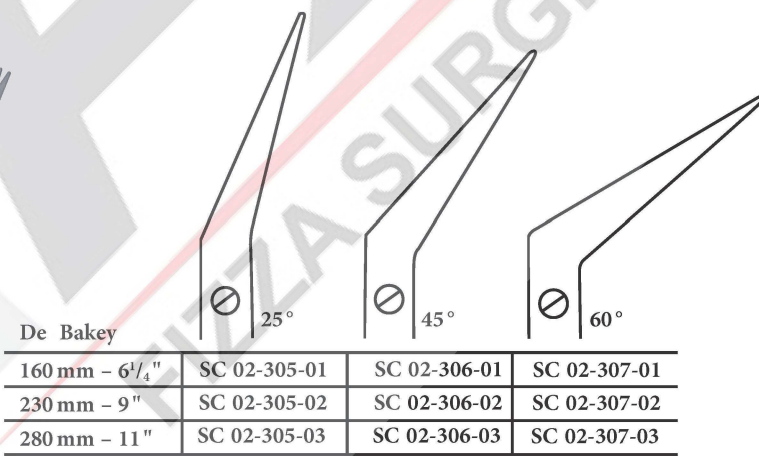
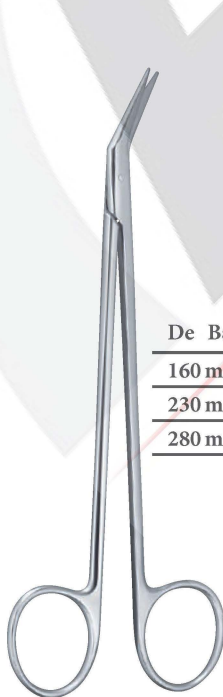
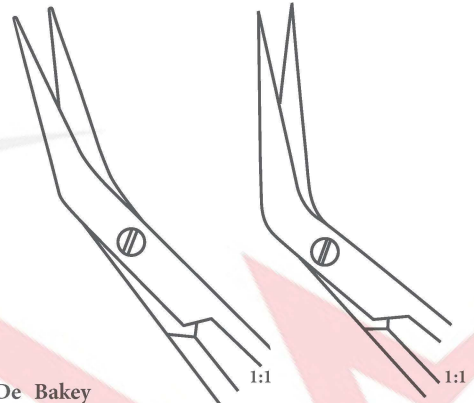

<b>De Bakey</b>			
160 mm – 6 <sup>1</sup> / <sub>4</sub> "	SC 02-305-01	SC 02-306-01	SC 02-307-01
230 mm – 9"	SC 02-305-02	SC 02-306-02	SC 02-307-02
280 mm – 11"	SC 02-305-03	SC 02-306-03	SC 02-307-03



**Mills**  
225 mm – 8<sup>3</sup>/<sub>4</sub>"  
SC 02-310-01

*Artery scissors*

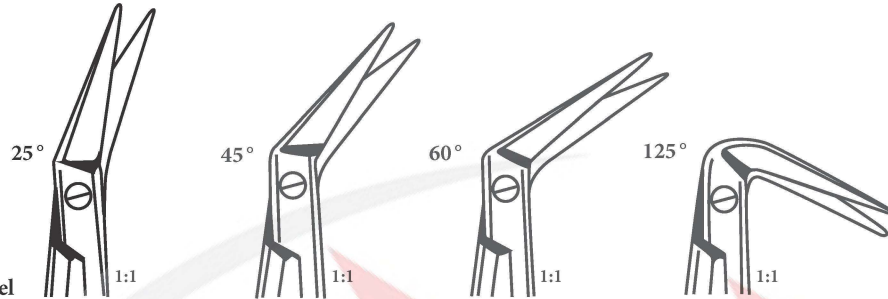
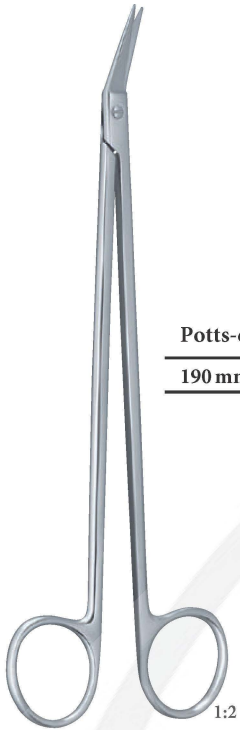

**Potts-de Martel**

190 mm - 7 1/2"	SC 02-315-01	SC 02-315-02	SC 02-315-03	SC 02-315-04
-----------------	--------------	--------------	--------------	--------------

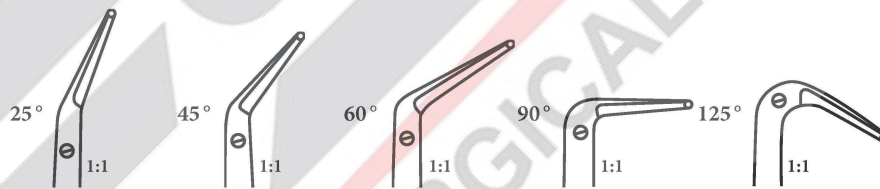

180 mm - 7"	SC 02-320-01	SC 02-320-02	SC 02-320-03	SC 02-320-04	SC 02-320-05
-------------	--------------	--------------	--------------	--------------	--------------

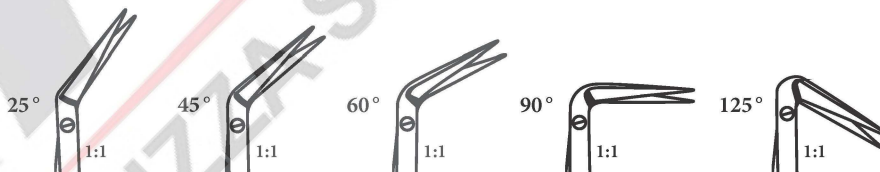

SC 02-320-07	SC 02-320-08	SC 02-320-09	SC 02-320-10	SC 02-320-11
--------------	--------------	--------------	--------------	--------------

*Artery scissors*

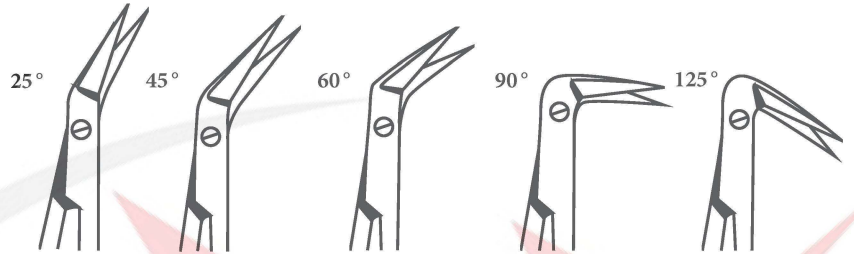

**Diethrich - Hegemann**

145 mm - 5 <sup>3</sup> / <sub>4</sub> "	SC 02-325-01	SC 02-326-01	SC 02-327-01	SC 02-328-01	SC 02-329-01
160 mm - 6 <sup>1</sup> / <sub>4</sub> "	SC 02-325-02	SC 02-326-02	SC 02-327-02	SC 02-328-02	SC 02-329-02
190 mm - 7 <sup>1</sup> / <sub>2</sub> "	SC 02-325-03	SC 02-326-03	SC 02-327-03	SC 02-328-03	SC 02-329-03



**Martin - Cartilage**  
190 mm - 7<sup>1</sup>/<sub>2</sub>" | SC 02-330-01  
*curved, Serrated Blade*



**Mc Indoe**  
190 mm - 7<sup>1</sup>/<sub>2</sub>" | SC 02-335-01

*Cartilage scissors*



**Potts - Smith**

190 mm - 7½"	SC 02-340-01
--------------	--------------



**Prince**

175 mm - 7"	SC 02-350-01
-------------	--------------



**Toennis**

180 mm - 7"
-------------



1:1

SC 02-360-01
--------------



1:1

SC 02-361-01
--------------



**Boettcher**

180 mm - 7"	SC 02-345-01
-------------	--------------



**Toennis - Adson**

170 mm - 6¾"	SC 02-355-01
--------------	--------------



**Dean**

170 cm - 6¾"
--------------

SC 02-365-01
--------------

*curved*

SC 02-366-01
--------------

*curved, Serrated Blade*

*Tonsil scissors*



<b>Wertheim</b>	
190 mm – 7½"	SC 02-370-01

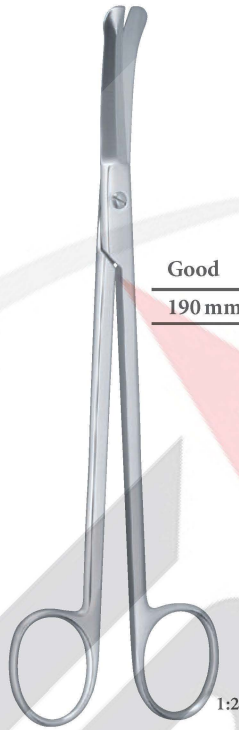

<b>Good</b>	
190 mm – 7½"	SC 02-380-01

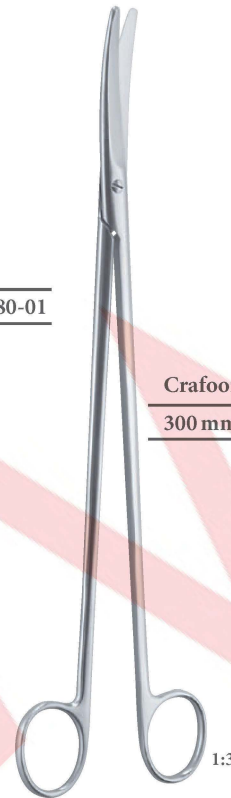

<b>Crafoord</b>	
300 mm – 12"	SC 02-385-01

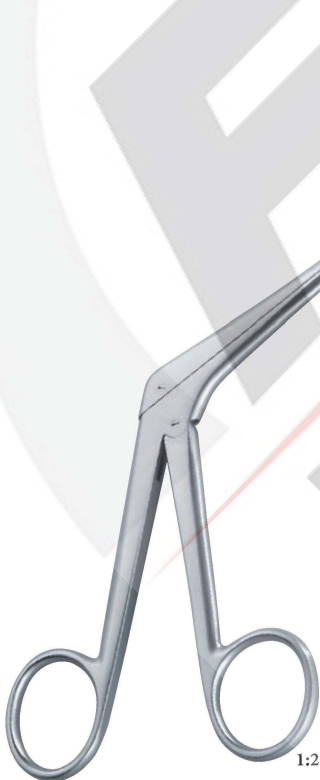

<b>Olivecrona</b>	
230 mm – 9"	SC 02-375-01

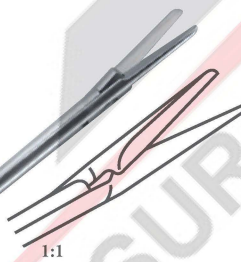

*Trigeminal scissors*



<b>Willauer</b>		
250 mm – 9¾"	SC 02-390-01	SC 02-391-01
280 mm – 11"	SC 02-390-02	SC 02-392-02
	<i>straight</i>	<i>curved</i>



*Lobectomy scissors*



**Finochietto**  
270 mm – 10<sup>3</sup>/<sub>4</sub>" | SC 02-400-01

1:3



**Resano**  
250 mm – 10" | SC 02-405-01

1:3



**Satinsky**  
245 mm – 9<sup>3</sup>/<sub>4</sub>" | SC 02-406-01

1:2

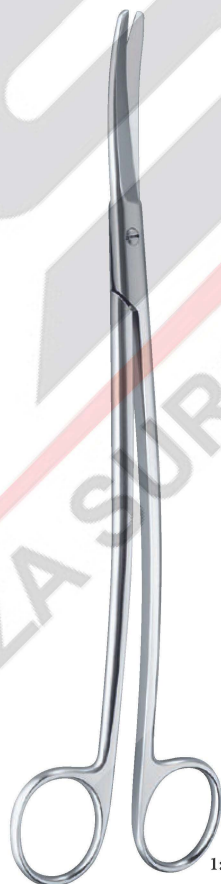

**Klinkenberg - Loth**  
230 mm – 9" | SC 02-410-01

1:2



**Jorgenson**  
220 mm – 8<sup>3</sup>/<sub>4</sub>" | SC 02-411-01

1:2

**Darmscheren *Enterotomy scissors***

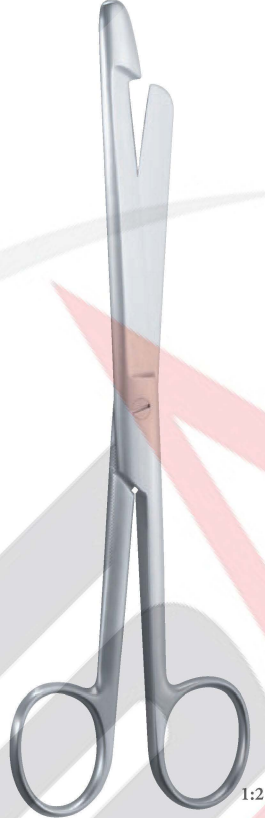

	<b>Fig. 1</b>	<b>Fig. 2</b>	<b>Fig. 3</b>
210 mm – 8 1/4"	SC 02-415-01	SC 02-420-01	SC 02-425-01

**Umbilical scissors**



**Busch**

130 mm – 5"	SC 02-426-01	SC 02-427-01
160 mm – 6 1/4"	SC 02-426-02	SC 02-427-02

**Schumacher**

160 mm – 6 1/4"	SC 02-430-01
-----------------	--------------

**Mod. USA**

105 mm – 4 1/4"	SC 02-435-01
-----------------	--------------

*Serrated Blade*



*Episiotomy scissors*

*Parametrium scissors*



**Braun - Stadler**

145 mm - 5 <sup>3</sup> / <sub>4</sub> "	SC 02-440-01
220 mm - 8 <sup>3</sup> / <sub>4</sub> "	SC 02-440-02

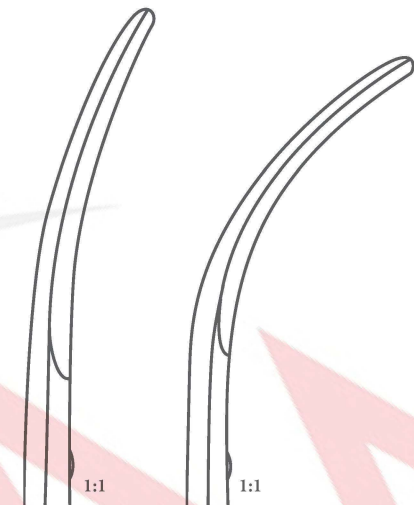
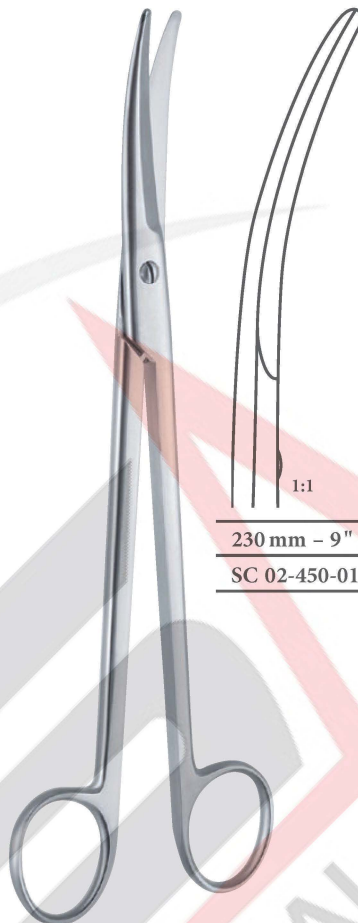

230 mm - 9"	225 mm - 8 <sup>3</sup> / <sub>4</sub> "
SC 02-450-01	SC 02-451-01



**Waldmann**

180 mm - 7"	SC 02-445-01
-------------	--------------

FIZZA SURGICAL

*Nasal scissors*



**Sailer**

170 mm - 6 <sup>3</sup> / <sub>4</sub> "	SC 02-455-01
--	--------------

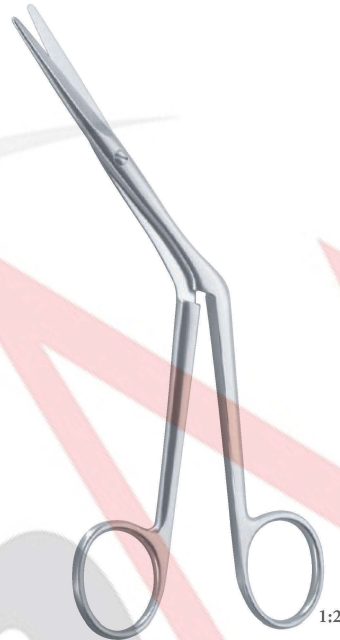

**Heymann**

180 mm - 7"	SC 02-460-01
-------------	--------------



**Fomon**

130 mm - 5"	SC 02-465-01
-------------	--------------

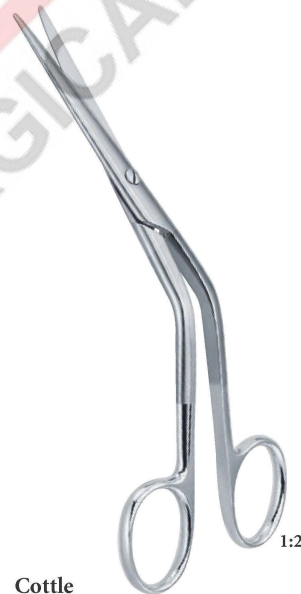



**Cottle**



160 mm - 6 <sup>1</sup> / <sub>4</sub> "	SC 02-470-01
--	--------------

*Micro scissors*



Noyes	 1:1	 1:1	 1:1
120 mm - 4 <sup>3</sup> / <sub>4</sub> "	SC 02-475-01	SC 02-476-01	SC 02-477-01
straight	sharp - sharp	sharp - blunt	blunt - blunt



Noyes	 1:1	 1:1	 1:1
120 mm - 4 <sup>3</sup> / <sub>4</sub> "	SC 02-480-01	SC 02-481-01	SC 02-482-01
angulated	sharp - sharp	sharp - blunt	blunt - blunt

*Micro scissors*



120 mm - 4 <sup>3</sup> / <sub>4</sub> "	SC 02-485-01
--	--------------

1:1

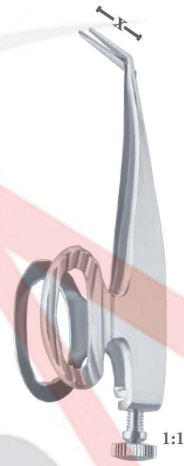

**Barraquer**

	55 mm - 2 <sup>1</sup> / <sub>4</sub> "
x = 7 mm	SC 02-490-01
x = 10 mm	SC 02-490-02

1:1



1:1

**Wecker**

110 mm - 4 <sup>1</sup> / <sub>4</sub> "	SC 02-495-01	SC 02-496-01	SC 02-497-01
	<i>sharp - blunt</i>	<i>blunt - blunt</i>	<i>sharp - sharp</i>



*Micro scissors*



Westcott

115 mm - 4 1/2"	SC 02-498-01	SC 02-499-01
-----------------	--------------	--------------



1:1



1:1



Castroviejo

90 mm - 3 1/2"	SC 02-500-01
----------------	--------------

1:1



Yasargil

185 mm - 7 1/4"	SC 02-501-01	SC 02-501-02	SC 02-501-03
-----------------	--------------	--------------	--------------



1:1



1:1



1:1

gerade  
straight

gebogen  
curved

kniegebogen  
angled on flat



**Micro scissors**



**Vannas**

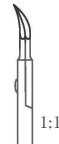
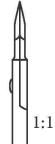

	7 mm Ø	7 mm Ø
120 mm – 5"	SC 02-502-01	SC 02-502-02

**Vannas**

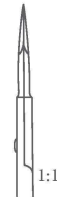

	8 mm Ø	8 mm Ø
150 mm – 6"	SC 02-503-01	SC 02-503-02

**Castroviejo**

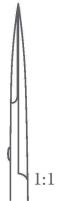

	8 mm Ø	8 mm Ø
150 mm – 6"	SC 02-504-01	SC 02-504-02



**Yasargil**

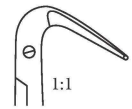
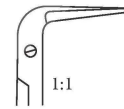
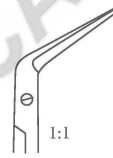

	25°	45°	60°	90°	125°
170 mm – 6 <sup>3</sup> / <sub>4</sub> "	SC 02-505-01	SC 02-505-01	SC 02-505-01	SC 02-505-01	SC 02-505-01

**mit Knopf  
with ball**

**Yasargil**

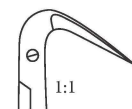
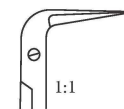
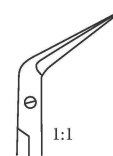
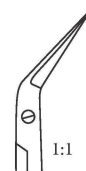

	25°	45°	60°	90°	125°
170 mm – 6 <sup>3</sup> / <sub>4</sub> "	SC 02-506-01	SC 02-506-01	SC 02-506-01	SC 02-506-01	SC 02-506-01

**ohne Knopf  
without ball**

1:1

*Micro scissors*



**Jacobson**



160 mm - 6 1/4"	SC 02-507-01	SC 02-507-02	SC 02-507-03
180 mm - 7"	SC 02-508-01	SC 02-508-02	SC 02-508-03

gerade  
straight

gebogen  
curved

abgewinkelt, 45°  
angled, 45°

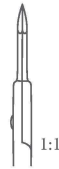

160 mm - 6 1/4"	SC 02-509-01	SC 02-512-01
180 mm - 7"	SC 02-509-02	SC 02-512-02

**Vannas**  
Schneide  
Vannas blade



<b>Vannas</b>		
80 mm - 3 1/4"	SC 02-510-01	SC 02-511-01



**Castroviejo**

100 mm - 4"	SC 02-515-01	SC 02-516-01
-------------	--------------	--------------

sharp - sharp

blunt - blunt



*Tenotomy scissors*



1:1

**Westcott**

110 mm – 4<sup>1</sup>/<sub>4</sub>"



1:1

SC 02-520-01

*sharp – sharp*



1:1

SC 02-521-01

*blunt – blunt*

*Irisscheren Iris scissors*



1:2

120 mm – 4<sup>3</sup>/<sub>4</sub>"



1:2

SC 02-525-01



1:2

SC 02-526-01



1:2

115 mm – 4<sup>1</sup>/<sub>2</sub>"



1:2

SC 02-530-01

*straight*



1:2

SC 02-531-01

*curved*



1:2

SC 02-532-01

*angular*



1:2

SC 02-533-01

*laterally curved*

*Tenotomy scissors*

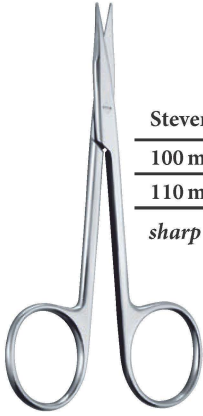
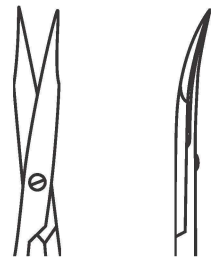
**Stevens**

100 mm – 4"	SC 02-535-01	SC 02-536-01
110 mm – 4 1/4"	SC 02-535-02	SC 02-536-02

*sharp – sharp*



**Graefe**

105 mm – 4 1/4"	SC 02-550-01
-----------------	--------------

1:2

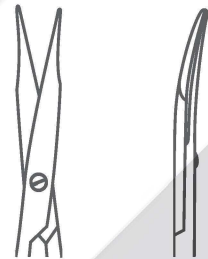
**Stevens**

100 mm – 4"	SC 02-540-01	SC 02-541-01
110 mm – 4 1/4"	SC 02-540-02	SC 02-541-02

*blunt – blunt*

115 mm – 4 1/2"	SC 02-555-01	SC 02-556-01
-----------------	--------------	--------------

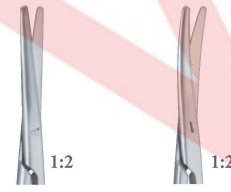
1:2



**Walton**

100 mm – 4"	SC 02-545-01
-------------	--------------

1:2

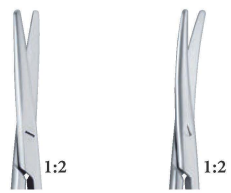
115 mm – 4 1/2"	SC 02-560-01	SC 02-561-01
-----------------	--------------	--------------

1:2

**Anatomische Scheren *Anatomy scissors***



115 mm – 4½"	SC 02-565-01	SC 02-566-01
130 mm – 5"	SC 02-565-02	SC 02-566-02
140 mm – 5½"	SC 02-565-03	SC 02-566-03

**Dura scissors**



**Taylor**

145 mm – 5¾"  
SC 02-570-01



**Dandy**

170 mm – 6¾"  
SC 02-580-01



**Schmieden**

170 mm – 6¾"  
SC 02-575-01



**Strully**

220 mm – 8¾"



SC 02-585-01



SC 02-586-01

*Ligature scissors*



**Littauer**  

140 mm - 5½"
SC 02-590-01

1:2



**O' Brien**  

90 mm - 3½"
SC 02-595-01

1:2



**Spencer**  

90 mm - 3½"	SC 02-600-01
105 mm - 4¼"	SC 02-600-02
130 mm - 5"	SC 02-600-03



**Northbent**  

115 mm - 4½"
SC 02-605-01

1:2



**Northbent**  

90 mm - 3½"	SC 02-615-01
125 mm - 5"	SC 02-615-02

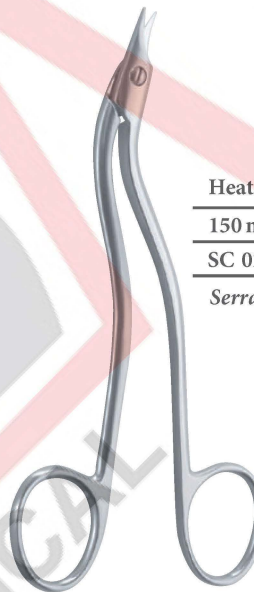

**Heath**  

150 mm - 6"
SC 02-620-01

  
*Serrated Blade*

1:2



**Buck**  

145 mm - 5¾"	SC 02-610-01
180 mm - 7"	SC 02-610-02

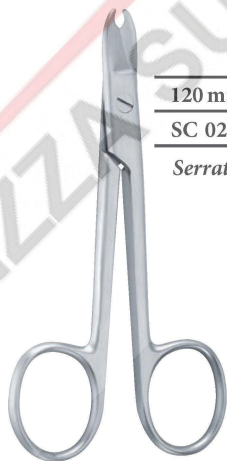

**Buck**  

120 mm - 4¾"
SC 02-625-01

  
*Serrated Blade*

1:2

*Ligature scissors*

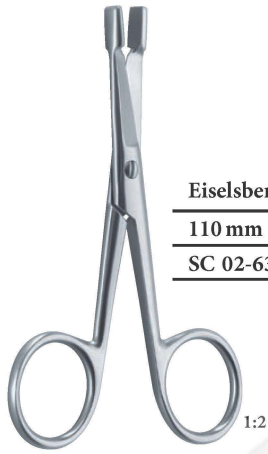

**Eiselsberg**  
 110 mm - 4<sup>1</sup>/<sub>4</sub>"  
 SC 02-630-01



105 mm - 4<sup>1</sup>/<sub>4</sub>"  
 SC 02-635-01

*Wire cutting scissors*



**Universal**  
 120 mm - 4<sup>3</sup>/<sub>4</sub>"  
 SC 02-640-01  
 Serrated Blade







**Harvey**  
 125 mm - 5"  
 SC 02-645-01  
 Serrated Blade



**Schuhknecht**  
 125 mm - 5"  
 SC 02-650-01  
 Serrated Blade



<b>Beebe</b>	 1:2	 1:2	 1:2	 1:2
100 mm - 4"	SC 02-655-01	SC 02-655-02	SC 02-655-03	SC 02-655-04
120 mm - 4 <sup>3</sup> / <sub>4</sub> "	SC 02-656-01	SC 02-656-02	SC 02-655-03	SC 02-656-04

*straight      blunt - blunt      sharp - sharp      blunt - blunt, Serrated Blade      sharp - sharp, Serrated Blade*



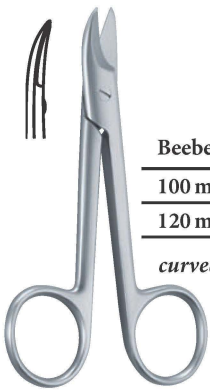

**Beebee**

100 mm – 4"	SC 02-670-01	SC 02-671-01	SC 02-672-01	SC 02-673-01
120 mm – 4 <sup>3</sup> / <sub>4</sub> "	SC 02-670-01	SC 02-671-02	SC 02-672-02	SC 02-673-02

*curved*

*blunt – blunt*

*sharp – sharp*

*blunt – blunt, Serrated Blade*

*sharp – sharp, Serrated Blade*



**Bandage scissors**



**Universal**

150 mm – 6"	SC 02-675-01
180 mm – 7"	SC 02-675-02

- Autoclavable
- Colour coated plastic handles & tips
- Note colours may vary from those pictured.

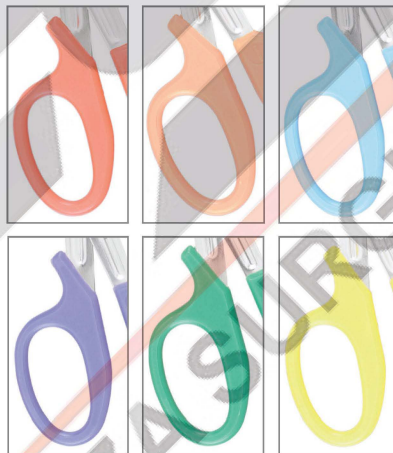

**Lister Bandage**

90 mm – 3 <sup>1</sup> / <sub>2</sub> "	SC 02-680-01
110 mm – 4 <sup>1</sup> / <sub>4</sub> "	SC 02-680-02
140 mm – 5 <sup>1</sup> / <sub>2</sub> "	SC 02-680-03
180 mm – 7"	SC 02-680-04
200 mm – 8"	SC 02-680-05



**Esmarch**

180 mm - 7"	SC 02-685-01
200 mm - 8"	SC 02-685-02

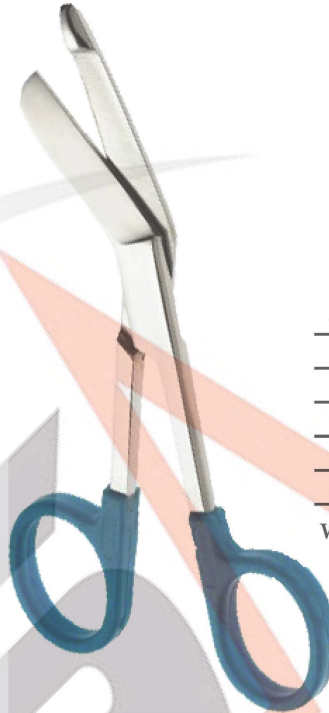

**Lister Bandage**

90 mm - 3 1/2"	SC 02-681-01
110 mm - 4 1/4"	SC 02-681-02
140 mm - 5 1/2"	SC 02-681-03
180 mm - 7"	SC 02-681-04
200 mm - 8"	SC 02-681-05

**With Plastic Handle**



**Gripmate Lister Bandage**

55 mm - 3 1/2"	SC 02-682-01
110 mm - 4 1/4"	SC 02-682-02
140 mm - 5 1/2"	SC 02-682-03
180 mm - 7"	SC 02-682-04
200 mm - 8"	SC 02-682-05



**Lister Bandage**

140 mm - 5 1/2"	SC 02-681-03
180 mm - 7"	SC 02-681-04
200 mm - 8"	SC 02-681-05

**Gold Plated**

*Bandage scissors*



<b>Lange</b>
180 mm - 7"
SC 02-690-01



<b>Knowles</b>
140 mm - 5 1/2"
SC 02-695-01

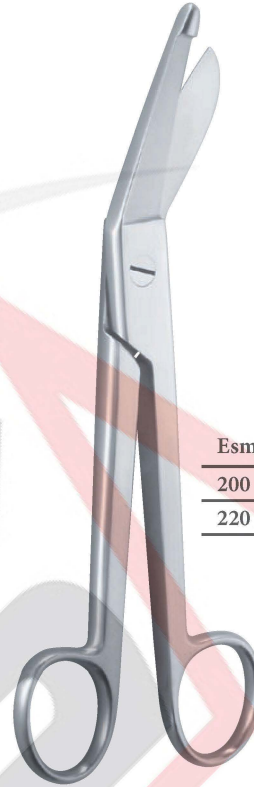

<b>Esmarch</b>	
200 mm - 8"	SC 02-710-01
220 mm - 8 3/4"	SC 02-710-02



160 mm - 6 1/4"
SC 02-700-01



<b>Smith (Mod. USA)</b>	
160 mm - 6 1/4"	SC 02-705-01
180 mm - 7"	SC 02-705-02
200 mm - 8"	SC 02-705-03
230 mm - 9"	SC 02-705-04



<b>Excentric</b>	
160 mm - 6 1/4"	SC 02-715-01
190 mm - 7 1/2"	SC 02-715-02

gezahnt  
Serrated Blade

*Bandage scissors – Plaster shears*



<b>Bergmann</b>	
230 mm – 9"	SC 02-720-01

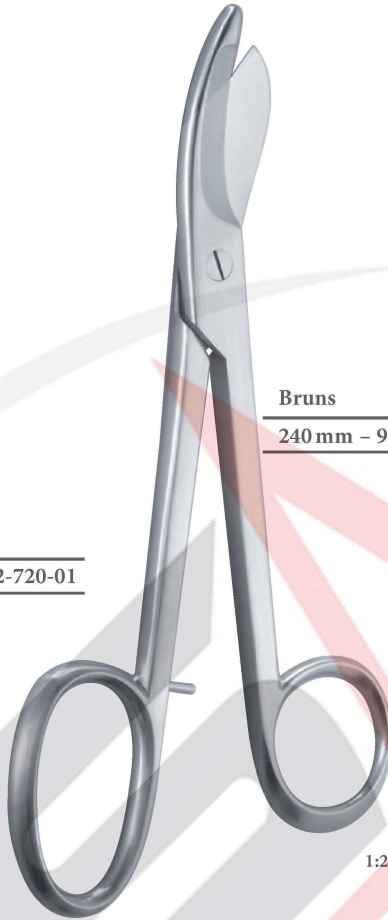

<b>Bruns</b>		
240 mm – 9½"	SC 02-725-01	SC 02-726-01
		<i>Serrated Blade</i>



<b>Lorenz</b>	
230 mm – 9"	SC 02-727-01



<b>First Aid Shear</b>	
200 mm – 8"	SC 02-730-01



<b>Seutin Plaster Shear</b>	
230 mm – 9"	SC 02-735-01



*Cuticle scissors – Nail scissors*

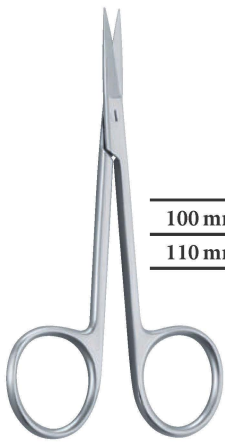

100 mm – 4"	SC 02-740-01	SC 02-741-01
110 mm – 4 <sup>1</sup> / <sub>4</sub> "	SC 02-740-02	SC 02-741-02



90 mm – 3 <sup>1</sup> / <sub>2</sub> "	SC 02-745-01	SC 02-746-01
100 mm – 4"	SC 02-745-02	SC 02-746-02
110 mm – 4 <sup>1</sup> / <sub>4</sub> "	SC 02-745-03	SC 02-746-03





*Nail splitting scissors*



130 mm – 5"	SC 02-750-01
150 mm – 6"	SC 02-750-02



Systrunk	 1:2	 1:2
130 mm – 5"	SC 02-755-01	SC 02-756-01



*Operating scissors*

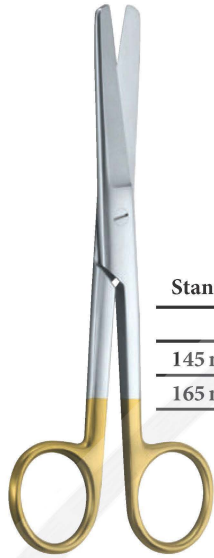

**Standard**

	Fig. 1	Fig. 2	Fig. 3
145 mm - 5 <sup>3</sup> / <sub>4</sub> "	SC 02-790-01	SC 02-791-01	SC 02-792-01
165 mm - 6 <sup>1</sup> / <sub>2</sub> "	SC 02-790-02	SC 02-791-02	SC 02-792-02

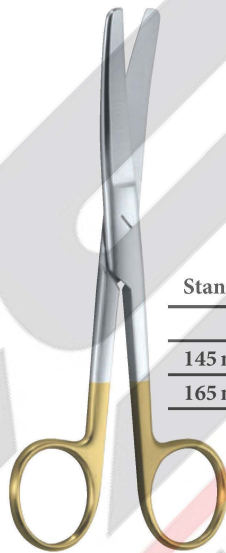

**Standard**

	Fig. 1	Fig. 2	Fig. 3
145 mm - 5 <sup>3</sup> / <sub>4</sub> "	SC 02-795-01	SC 02-796-01	SC 02-797-01
165 mm - 6 <sup>1</sup> / <sub>2</sub> "	SC 02-795-02	SC 02-796-02	SC 02-797-02



**Lexer**

165 mm - 6 <sup>1</sup> / <sub>4</sub> "	SC 02-800-01	SC 02-801-01
210 mm - 8 <sup>1</sup> / <sub>4</sub> "	SC 02-800-02	SC 02-801-02



*Operating scissors – Dissecting scissors*

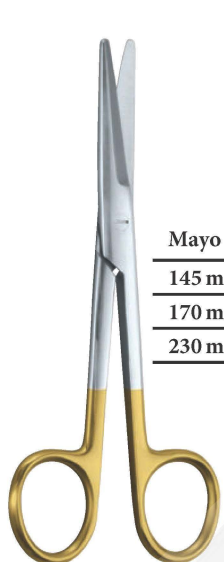

Mayo

145 mm – 5 <sup>3</sup> / <sub>4</sub> "	SC 02-805-01	SC 02-806-01
170 mm – 6 <sup>3</sup> / <sub>4</sub> "	SC 02-805-02	SC 02-806-02
230 mm – 9"	SC 02-805-03	SC 02-806-03



Mayo - Stille

150 mm – 6"	SC 02-810-01	SC 02-811-01
170 mm – 6 <sup>3</sup> / <sub>4</sub> "	SC 02-810-02	SC 02-811-02



Metzenbaum

	Fig. 1	Fig. 2	Fig. 3
115 mm – 4 <sup>1</sup> / <sub>2</sub> "	SC 02-815-01	SC 02-816-01	SC 02-817-01
145 mm – 5 <sup>3</sup> / <sub>4</sub> "	SC 02-815-02	SC 02-816-02	SC 02-817-02
180 mm – 7"	SC 02-815-03	SC 02-816-03	SC 02-817-03
200 mm – 8"	SC 02-815-04	SC 02-816-04	SC 02-817-04
230 mm – 9"	SC 02-815-05	SC 02-816-05	SC 02-817-05
250 mm – 10"	SC 02-815-06	SC 02-816-06	SC 02-817-06
280 mm – 11"	SC 02-815-07	SC 02-816-07	SC 02-817-07
300 mm – 12"	SC 02-815-08	SC 02-816-08	SC 02-817-08



Metzenbaum

	Fig. 1	Fig. 2	Fig. 3
115 mm – 4 <sup>1</sup> / <sub>2</sub> "	SC 02-827-01	SC 02-828-01	SC 02-829-01
145 mm – 5 <sup>3</sup> / <sub>4</sub> "	SC 02-827-02	SC 02-828-02	SC 02-829-02
180 mm – 7"	SC 02-827-03	SC 02-828-03	SC 02-829-03
200 mm – 8"	SC 02-827-04	SC 02-828-04	SC 02-829-04
230 mm – 9"	SC 02-827-05	SC 02-828-05	SC 02-829-05
250 mm – 10"	SC 02-827-06	SC 02-828-06	SC 02-829-06
280 mm – 11"	SC 02-827-07	SC 02-828-07	SC 02-829-07
300 mm – 12"	SC 02-827-08	SC 02-828-08	SC 02-829-08



**Operating scissors – Dissecting scissors**

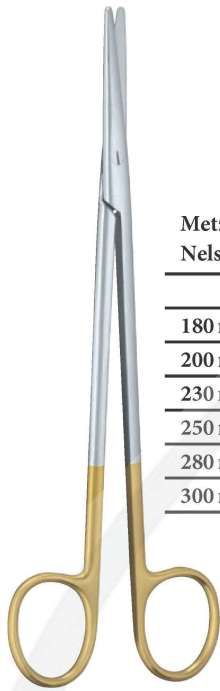

**Metzenbaum - Nelson**

	Fig. 1	Fig. 2	Fig. 3
180 mm – 7"	SC 02-825-01	SC 02-826-01	SC 02-827-01
200 mm – 8"	SC 02-825-02	SC 02-826-02	SC 02-827-02
230 mm – 9"	SC 02-825-03	SC 02-826-03	SC 02-827-03
250 mm – 10"	SC 02-825-04	SC 02-826-04	SC 02-827-05
280 mm – 11"	SC 02-825-05	SC 02-826-05	SC 02-827-06
300 mm – 12"	SC 02-835-06	SC 02-836-06	SC 02-837-07



**Metzenbaum - Fino**

	Fig. 1
145 mm – 5 <sup>3</sup> / <sub>4</sub> "	SC 02-840-01



**Metzenbaum - Nelson**

	Fig. 1	Fig. 2	Fig. 3
180 mm – 7"	SC 02-831-01	SC 02-832-01	SC 02-833-01
200 mm – 8"	SC 02-831-02	SC 02-832-02	SC 02-833-02
230 mm – 9"	SC 02-831-03	SC 02-832-03	SC 02-833-03
250 mm – 10"	SC 02-831-04	SC 02-832-04	SC 02-833-04
280 mm – 11"	SC 02-831-05	SC 02-832-05	SC 02-833-05
300 mm – 12"	SC 02-831-06	SC 02-832-06	SC 02-833-06
350 mm – 14"	SC 02-831-07	SC 02-832-07	SC 02-833-07

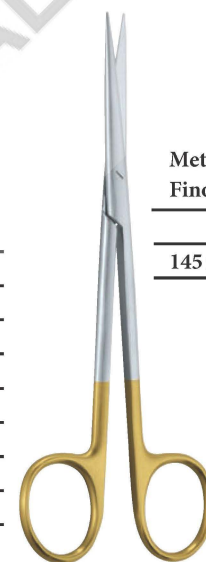

**Metzenbaum - Fino**

	Fig. 3
145 mm – 5 <sup>3</sup> / <sub>4</sub> "	SC 02-845-01



*Dissecting scissors*

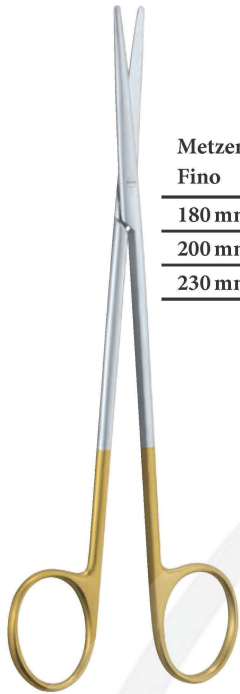

**Metzenbaum -  
Fino**

180 mm - 7"	SC 02-850-01	SC 02-851-01
200 mm - 8"	SC 02-850-02	SC 02-851-02
230 mm - 9"	SC 02-850-03	SC 02-851-03

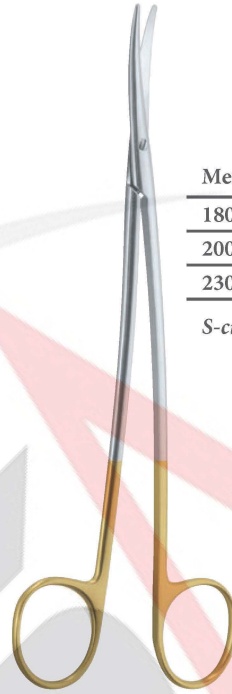

**Metzenbaum - Fino**

180 mm - 7"	SC 02-855-01
200 mm - 8"	SC 02-855-02
230 mm - 9"	SC 02-855-03

*S-curved*

**Feine Scheren  
Fine scissors**

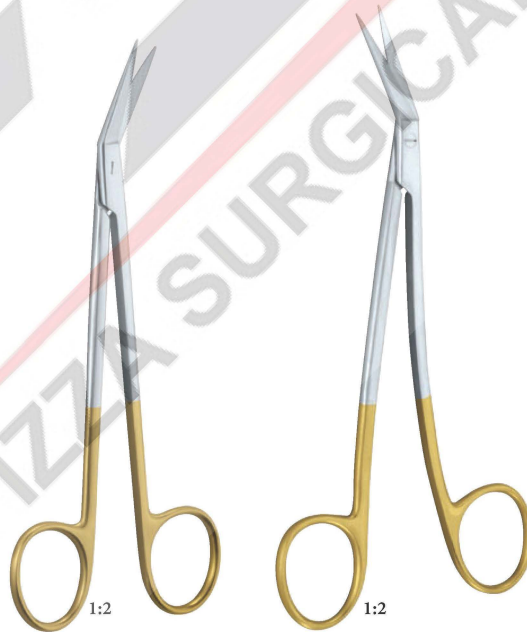

**Locklin**

165 mm - 6 1/2"	SC 02-860-01	SC 02-861-01
-----------------	--------------	--------------

*straight, Serrated Blade*

*curved, Serrated Blade*

*Plastic surgery scissors*



**Gorney**

200 mm - 8"



**Gorney**

SC 02-865-01



**Gorney**

SC 02-866-01



**Kaye**

115 mm - 4 1/2"

SC 02-870-01



*Artery scissors*

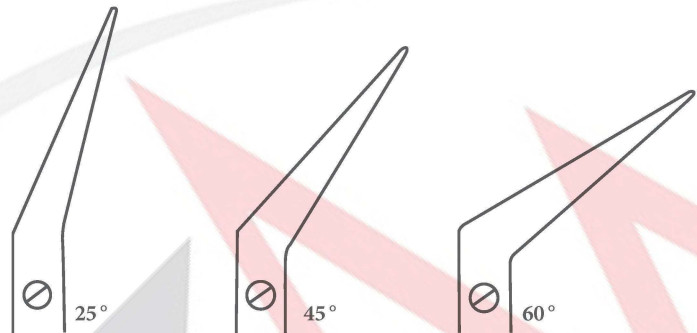

De Bakey	25°	45°	60°
160 mm – 6 1/4"	SC 02-875-01	SC 02-876-02	SC 02-877-03
230 mm – 9"	SC 02-875-02	SC 02-876-02	SC 02-877-02
280 mm – 11"	SC 02-875-03	SC 02-876-03	SC 02-877-03

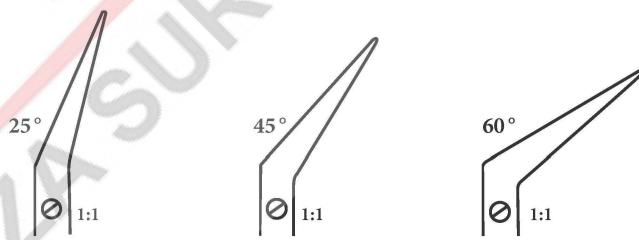

Potts - de Martel	25°	45°	60°
190 mm – 7 1/2"	SC 02-880-01	SC 02-881-01	SC 02-882-01

*Tonsil scissors*



**Toennis -  
Adson**

170 mm - 6 <sup>3</sup> / <sub>4</sub> "
SC 02-885-01

1:2



**Dean**

170 mm - 6 <sup>3</sup> / <sub>4</sub> "
SC 02-890-01

*curved, Serrated Blade*

1:2

*Parametrium scissors*



1:2



1:1

230 mm - 9"	225 mm - 8 <sup>3</sup> / <sub>4</sub> "
SC 02-895-01	SC 02-896-01



1:1

*Iris scissors*

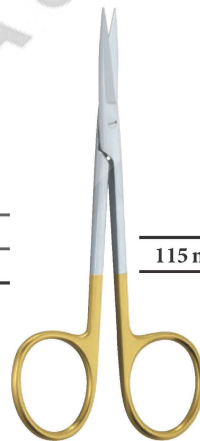

1:2



1:2



1:2



1:2

115 mm - 4 <sup>1</sup> / <sub>2</sub> "	SC 02-900-01	SC 02-901-01	SC 02-902-01
--	--------------	--------------	--------------

*straight*

*curved*

*angular*

*Bandage scissors*

*Wire cutting scissors*

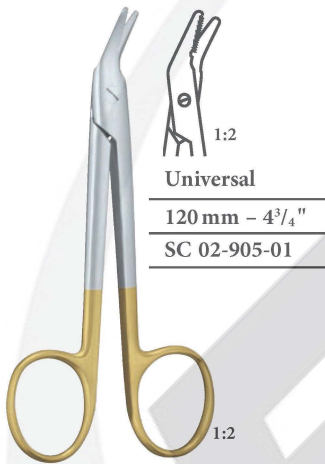

**Universal**  
120 mm - 4<sup>3</sup>/<sub>4</sub>"  
SC 02-905-01



**Lister**  
180 mm - 7"  
SC 02-910-01

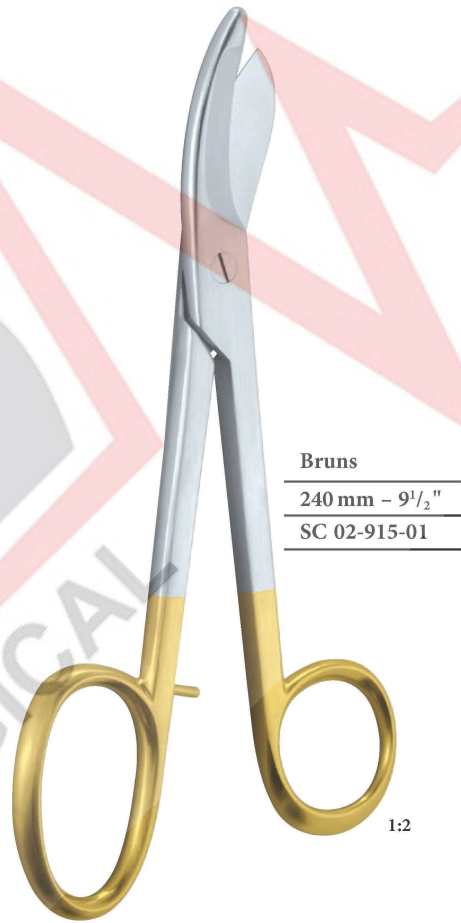

**Bruns**  
240 mm - 9<sup>1</sup>/<sub>2</sub>"  
SC 02-915-01

**Operating scissors**



1:2

**Lexer**

160 mm - 6 <sup>1</sup> / <sub>4</sub> "	SC 02-915-01	SC 02-916-01
--	--------------	--------------



1:2

**Metzenbaum**

145 mm - 5 <sup>3</sup> / <sub>4</sub> "	SC 02-930-01	SC 02-931-01
--	--------------	--------------



1:2

**Mayo**

150 mm - 6 <sup>3</sup> / <sub>4</sub> "	SC 02-920-01	SC 02-921-01
170 mm - 6 <sup>3</sup> / <sub>4</sub> "	SC 02-920-02	SC 02-921-02
230 mm - 9"	SC 02-902-03	SC 02-921-03



1:2

**Metzenbaum - Nelson**

	Fig. 1	Fig. 1
180 mm - 7"	SC 02-935-01	SC 02-936-01
200 mm - 8"	SC 02-935-02	SC 02-936-02
230 mm - 9"	SC 02-935-03	SC 02-936-03



1:2

**Mayo - Stille**

150 mm - 6"	SC 02-925-01	SC 02-921-01
170 mm - 6 <sup>3</sup> / <sub>4</sub> "	SC 02-925-02	SC 02-926-02



1:2

115 mm - 4 <sup>1</sup> / <sub>2</sub> "	SC 02-940-01	SC 02-941-01
--	--------------	--------------

*Operating scissors*

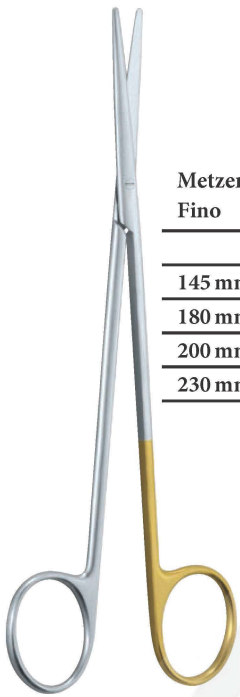

**Metzenbaum -  
Fino**

	Fig. 1	Fig. 2
145 mm - 5 <sup>3</sup> / <sub>4</sub> "	SC 02-945-01	SC 02-946-01
180 mm - 7"	SC 02-945-01	SC 02-946-02
200 mm - 8"	SC 02-945-01	SC 02-946-03
230 mm - 9"	SC 02-945-01	SC 02-946-03

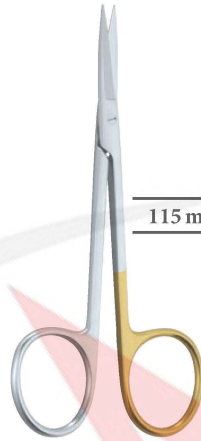

115 mm - 4<sup>1</sup>/<sub>2</sub>"



1:2

1:2

SC 02-950-01

SC 02-951-01

1:2



**Goldmann -  
Fox**

130 mm - 5"



1:2

SC 02-955-01



1:2

SC 02-956-01

1:2

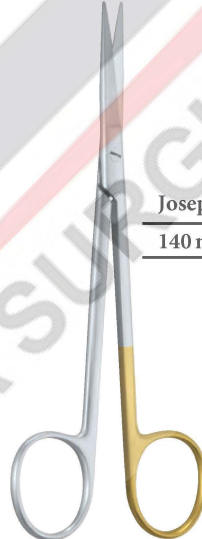

**Joseph**

140 mm - 5<sup>1</sup>/<sub>2</sub>"



1:2



1:2

SC 02-960-01

SC 02-961-01

1:2



*Operating scissors*



**Reynolds**

160 mm - 6 <sup>1</sup> / <sub>4</sub> "	SC 02-965-01	SC 02-966-01
180 mm - 7"	SC 02-965-02	SC 02-966-02



**Fomon**

130 mm - 5"
SC 02-970-01

1:2

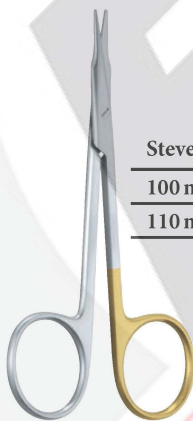

**Stevens**

100 mm - 4"	SC 02-975-01	SC 02-976-01
110 mm - 4 <sup>1</sup> / <sub>4</sub> "	SC 02-975-02	SC 02-976-02



**Kelly-Gubisch**

160 mm - 6 <sup>1</sup> / <sub>4</sub> "
SC 02-977-01





**LaGrange**  
110 mm - 4<sup>1</sup>/<sub>4</sub>"    SC 02-1000-01



**Standard**  
145 mm 5<sup>6</sup>/<sub>8</sub>"    SC 02-1005-01



**Mayo**

145 mm - 5 <sup>6</sup> / <sub>8</sub> "	SC 02-1010-01
170 mm - 6 <sup>6</sup> / <sub>8</sub> "	SC 02-1010-02
230 mm - 9 <sup>2</sup> / <sub>8</sub> "	SC 02-1010-03



**Mayo**

145 mm - 5 <sup>6</sup> / <sub>8</sub> "	SC 02-1011-01
170 mm - 6 <sup>6</sup> / <sub>8</sub> "	SC 02-1011-02
230 mm - 9 <sup>2</sup> / <sub>8</sub> "	SC 02-1011-03

Curved



Mayo-Style

180 mm - 7"	SC 02-1015-01	SC 02-1016-01
200 mm - 8"	SC 02-1015-02	SC 02-1016-02

Straight

Curved

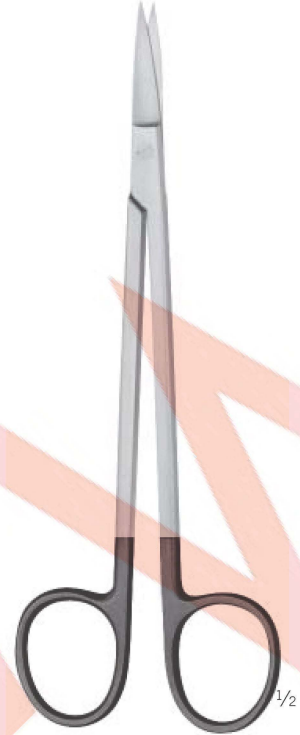

Kelly

160 mm 6 2/8"	SC 02-1020-01
---------------	---------------



Metzenbaum

115 mm 4 4/8"	SC 02-1025-01	SC 02-1026-01
145 mm 5 4/8"	SC 02-1025-02	SC 02-1026-02

Straight

Curved



Metzenbaum

115 mm 4 4/8"	SC 02-1030-01	SC 02-1031-01
---------------	---------------	---------------

Straight

Curved



TCC BlackLine



Metzenbaum

180 mm - 7 1/8"	SC 02-1035-01	SC 02-1036-01
205 mm - 8 1/8"	SC 02-1035-02	SC 02-1036-02
230 mm - 9"	SC 02-1035-03	SC 02-1036-03
260 mm 10 2/8"	SC 02-1035-04	SC 02-1036-04
285 mm 11 2/8"	SC 02-1035-05	SC 02-1036-05
310 mm / 12 2/8"	SC 02-1035-06	SC 02-1036-06



TCC BlackLine

Metzenbaum

180 mm - 7 1/8"	SC 02-1040-01	SC 02-1041-01
205 mm - 8 1/8"	SC 02-1040-02	SC 02-1041-02
230 mm - 9"	SC 02-1040-03	SC 02-1041-03
260 mm 10 2/8"	SC 02-1040-04	SC 02-1041-04
285 mm 11 2/8"	SC 02-1040-05	SC 02-1041-05
310 mm / 12 2/8"	SC 02-1040-06	SC 02-1041-06



Lexer

160 mm 6 2/8"	SC 02-1045-01	SC 02-1046-01
	Straight	Curved



TCC BlackLine

Lexer

160 mm 6 2/8"	SC 02-1050-01
---------------	---------------



Lexer-Baby

100 mm	3 7/8"	SC 02-1055-01	SC 02-1056-01
		Straight	Curved

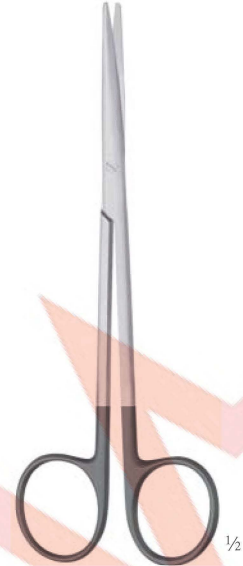

Metzenbaum-Fino

145 mm	5 6/8"	SC 02-1060-01	SC 02-1061-01
180 mm	7 1/8"	SC 02-1060-02	SC 02-1061-02
205 mm	8 1/8"	SC 02-1060-03	SC 02-1061-03
230 mm	9"	SC 02-1060-04	SC 02-1061-04



Lexer-Baby

100 mm	3 7/8"	SC 02-1065-01	SC 02-1066-01
		Straight	Curved



Kilner

120 mm	4 6/8"	SC 02-1070-01
150 mm	5 7/8"	SC 02-1070-02



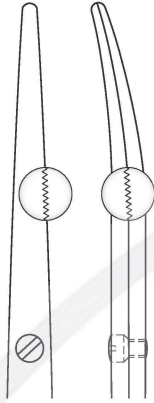
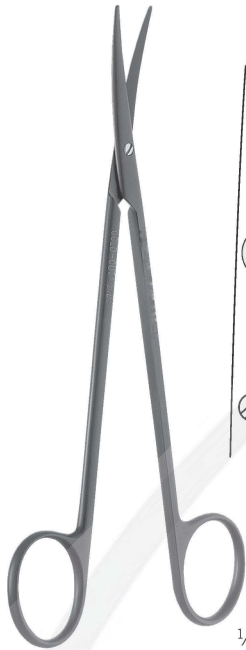

**TOENNIS-ADSON**

170 mm 6 3/4" SC 02-1075-01



**REYNOLDS**

160 mm 6 3/4" SC 02-1080-01



Micro 2000		
150 mm - 6"	SC 02-1200-01	SC 02-1201-01
	Straight	Curved