

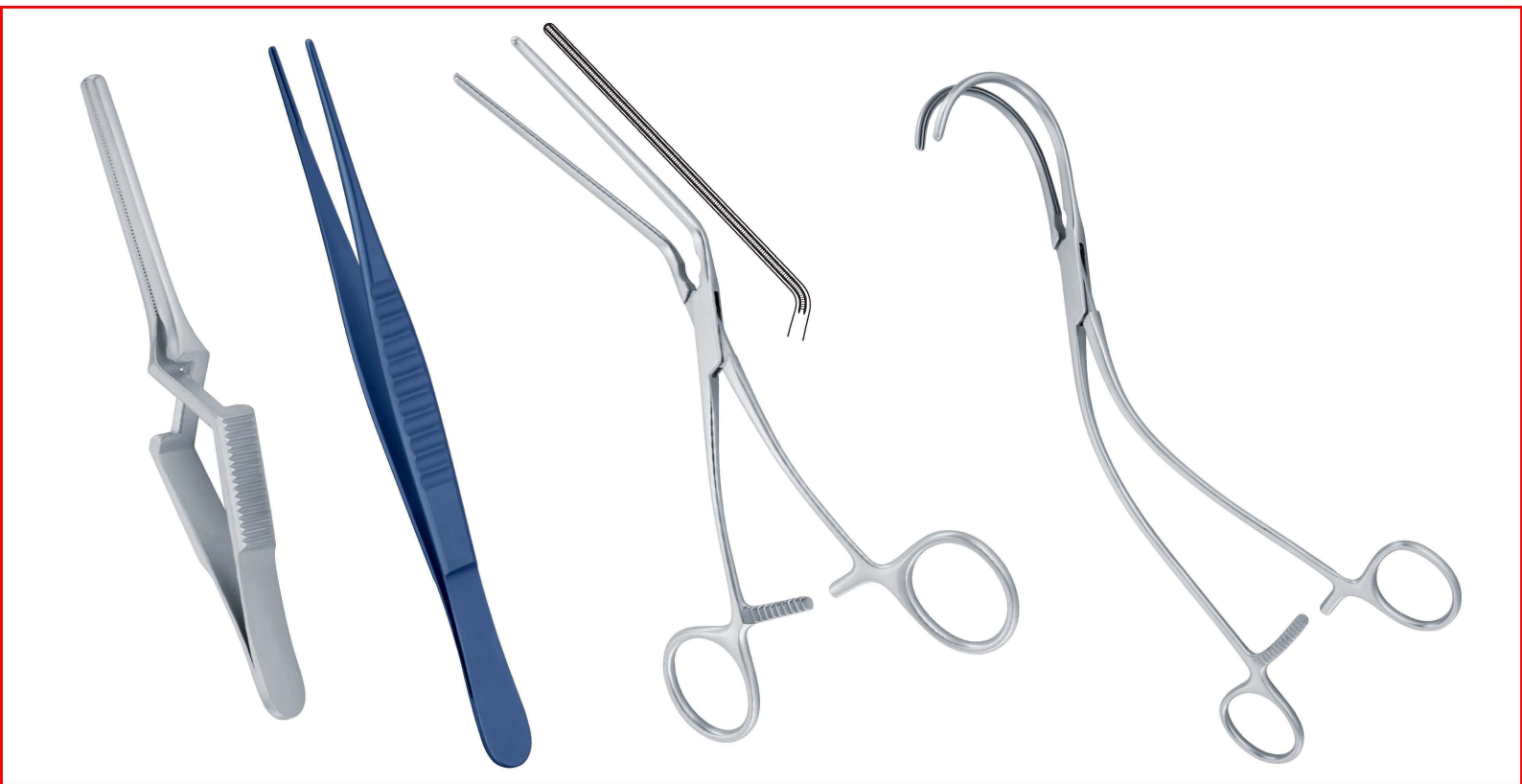

GEFÄSSCHIRURGIE – VASCULAR SURGERY

By

Fizza Surgical International



Bulldogklemmen
Bulldog clamps
Clamps Bulldog
Clamps Bulldog
Pinze Bulldog

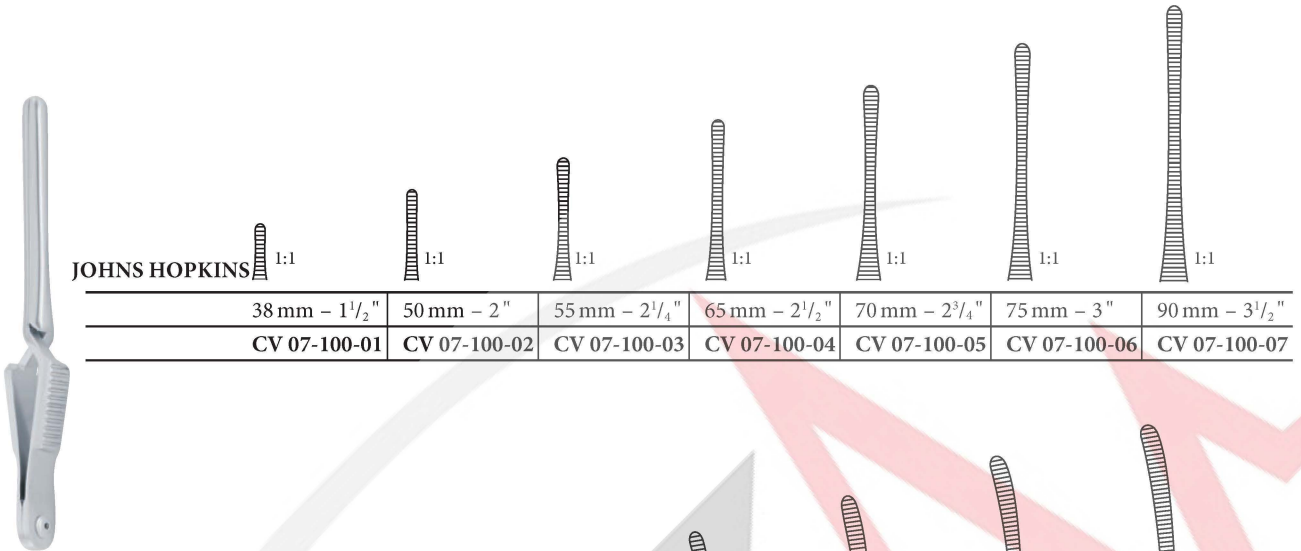

JOHNS HOPKINS	1:1	1:1	1:1	1:1	1:1	1:1	1:1
	38 mm – 1½"	50 mm – 2"	55 mm – 2¼"	65 mm – 2½"	70 mm – 2¾"	75 mm – 3"	90 mm – 3½"
	CV 07-100-01	CV 07-100-02	CV 07-100-03	CV 07-100-04	CV 07-100-05	CV 07-100-06	CV 07-100-07

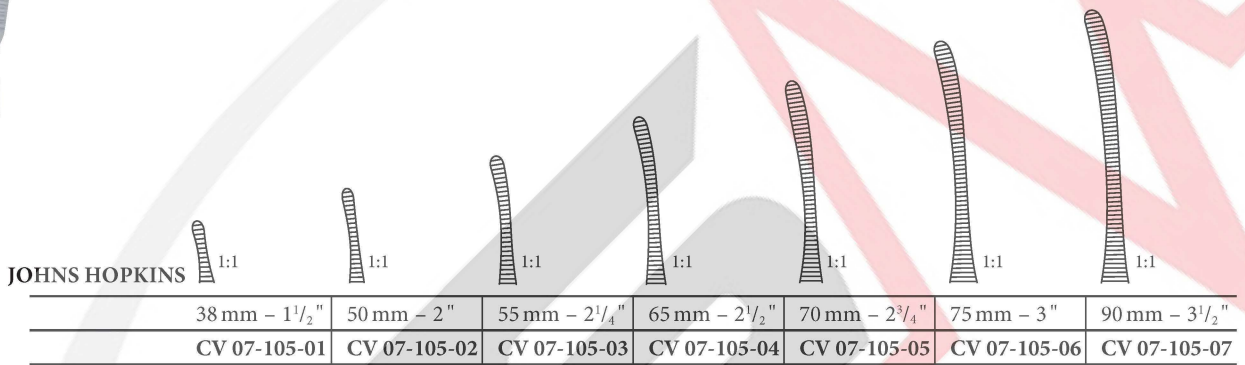

JOHNS HOPKINS	1:1	1:1	1:1	1:1	1:1	1:1	1:1
	38 mm – 1½"	50 mm – 2"	55 mm – 2¼"	65 mm – 2½"	70 mm – 2¾"	75 mm – 3"	90 mm – 3½"
	CV 07-105-01	CV 07-105-02	CV 07-105-03	CV 07-105-04	CV 07-105-05	CV 07-105-06	CV 07-105-07



CV 07-111-01
Bulldog clamps Holder



235 mm – 9¼"
CV 07-110-01

Applying forceps for Bulldog clamps

1:2

**Bulldogklemmen
Clamps Bulldog
Clamps Bulldog
Pinze Bulldog**



1:1

DIETRICH

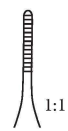

1:1

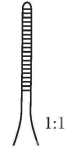

1:1

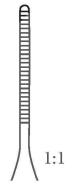

1:1

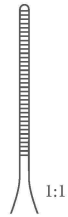

1:1

8 mm	12 mm	16 mm	20 mm
CV 07-115-01	CV 07-115-02	CV 07-115-03	CV 07-115-04



1:1

DIETRICH



1:1

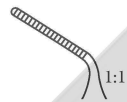

1:1

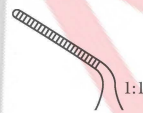

1:1

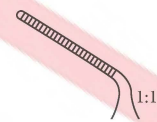

1:1

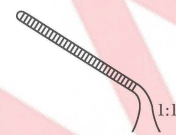

1:1

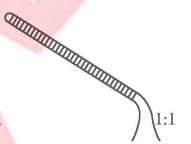

1:1

8 mm	12 mm	13 mm	16 mm	18 mm	20 mm
CV 07-120-01	CV 07-120-02	CV 07-120-03	CV 07-120-04	CV 07-120-05	CV 07-120-06



COOLEY

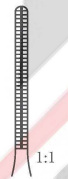

1:1



1:1

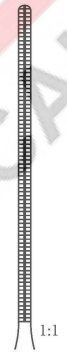

1:1

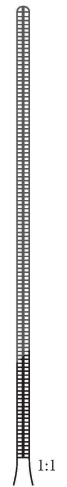

1:1

80 mm – 3 ¹ / ₄ "	90 mm – 3 ¹ / ₂ "	105 mm – 4 ¹ / ₄ "	125 mm – 5 "
CV 07-125-01	CV 07-125-02	CV 07-125-03	CV 07-125-04

COOLEY

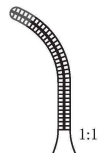

1:1

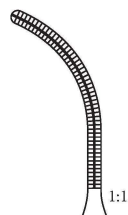

1:1

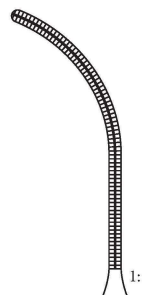

1:1

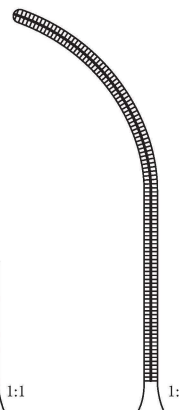



1:1



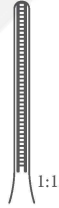
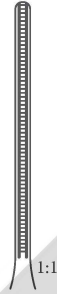

75 mm – 3 "	85 mm – 3 ¹ / ₄ "	95 mm – 3 ³ / ₄ "	115 mm – 4 ¹ / ₂ "
CV 07-130-01	CV 07-130-02	CV 07-130-03	CV 07-130-04

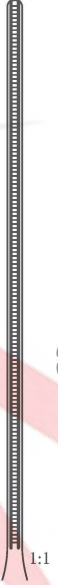
Bulldogklemmen
Bulldog clamps
Clamps Bulldog
Pinze Bulldog



DE BAKEY				
	75 mm – 3"	85 mm – 3 ¹ / ₄ "	105 mm – 4 ¹ / ₄ "	120 mm – 4 ³ / ₄ "
	CV 07-135-01	CV 07-135-02	CV 07-135-03	CV 07-135-04

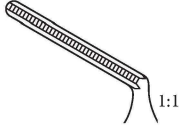

DE BAKEY					
	70 mm – 2 ³ / ₄ "	80 mm – 3 ¹ / ₄ "	100 mm – 4"	115 mm – 4 ¹ / ₂ "	55 mm – 2 ¹ / ₄ "
	CV 07-140-01	CV 07-140-02	CV 07-140-03	CV 07-140-04	CV 07-140-05

Angled on flat

Bulldogklemmen
Bulldog clamps
Clamps Bulldog
Pinze Bulldog



GLOVER	1:1	1:1	1:1	1:1
	60 mm – 2 1/2"	70 mm – 2 3/4"	90 mm – 3 1/2"	110 mm – 4 1/4"
	CV 07-145-01	CV 07-145-02	CV 07-145-03	CV 07-145-04



GLOVER	1:1	1:1	1:1	1:1	1:1
	55 mm – 2 1/4"	65 mm – 2 1/2"	85 mm – 3 1/4"	105 mm – 4 1/4"	50 mm – 2"
	CV 07-150-01	CV 07-150-02	CV 07-150-03	CV 07-150-04	CV 07-150-05

Angled on flat

Bulldogklemmen
Bulldog clamps
Clamps Bulldog
Pinze Bulldog

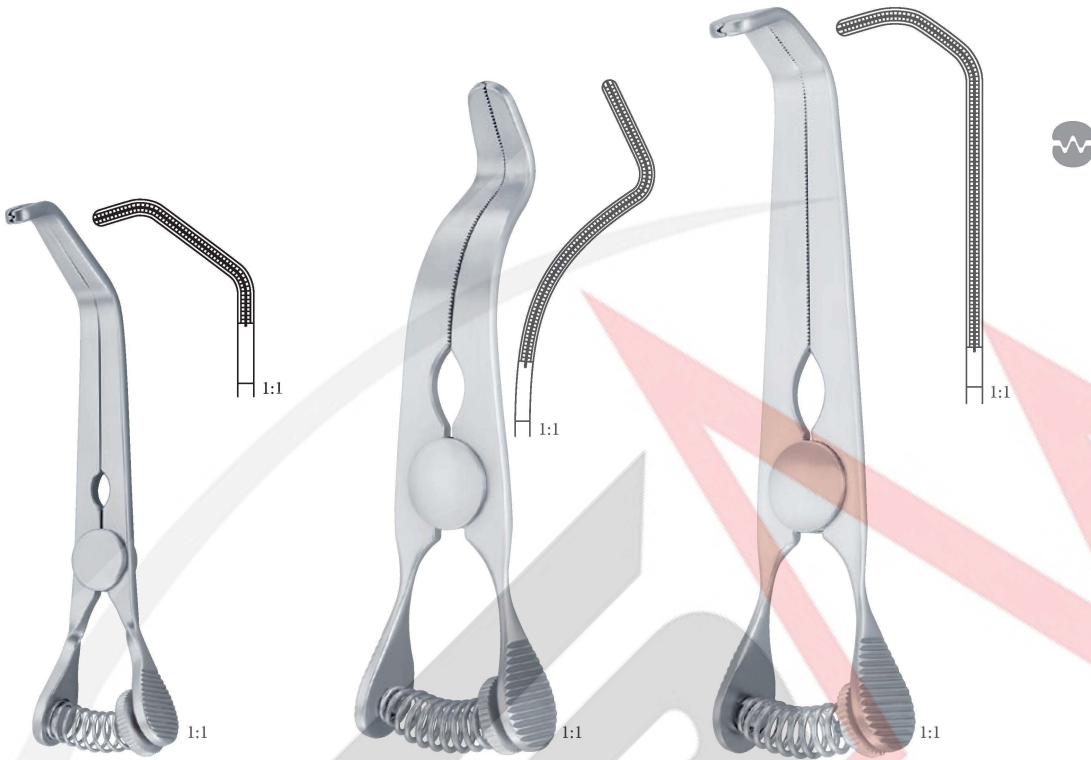

DE BAKEY-SATINSKY

70 mm – 2³/₄ "

CV 07-155-01

DE BAKEY- CAROTIS

90 mm – 3¹/₂ "

CV 07-160-01

DE BAKEY-SATINSKY

100 mm – 4 "

CV 07-165-01

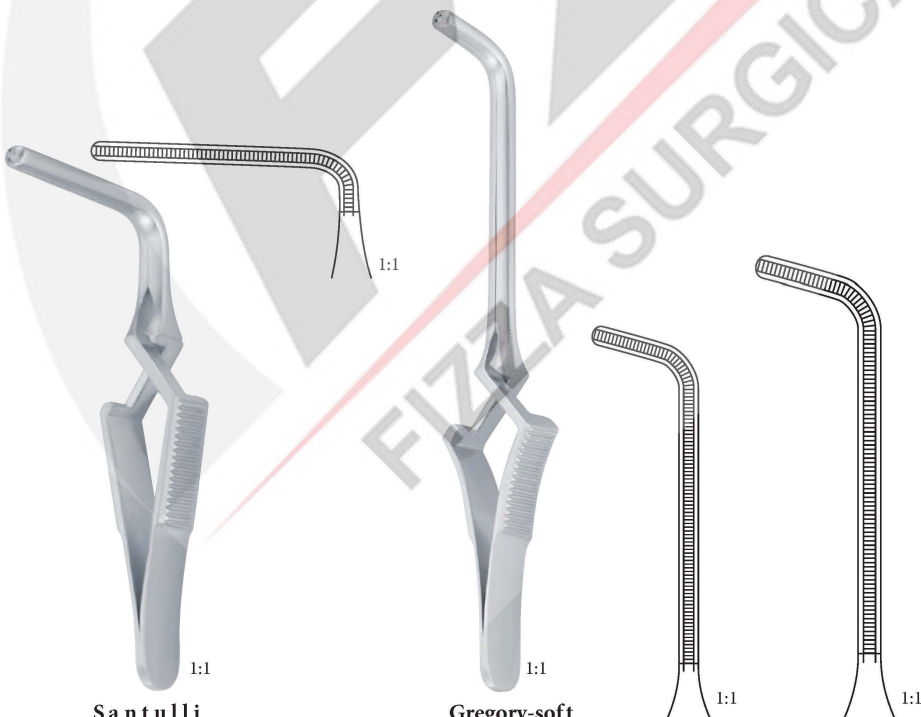

Santulli

70 mm – 2³/₄ "

CV 07-170-01

Gregory-soft

90 mm – 3¹/₂ "

CV 07-175-01

110 mm – 4¹/₄ "

CV 07-175-02

Atraumatische Pinzetten
Atraumatic tissue forceps
Pinces atraumatiques
Pinzas atraumáticas de disección
Pinze atraumatiche per dissezione

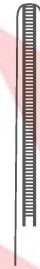

DE BAKEY	x = 1.5 mm	x = 2.0 mm	x = 2.7 mm	x = 3.5 mm
120 mm – 4 ³ / ₄ "	CV 07-180-01			
145 mm – 5 ³ / ₄ "	CV 07-180-02	CV 07-181-01		
160 mm – 6 ¹ / ₄ "	CV 07-180-03	CV 07-181-02	CV 07-182-01	CV 07-183-01
200 mm – 8"	CV 07-180-04	CV 07-181-03	CV 07-182-02	CV 07-183-02
240 mm – 9 ¹ / ₂ "	CV 07-180-05	CV 07-181-04	CV 07-182-03	CV 07-183-03
300 mm – 12"		CV 07-181-05	CV 07-182-04	CV 07-183-04
350 mm – 14"				CV 07-183-05

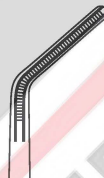

	x = 2.0 mm
145 mm – 5 ³ / ₄ "	
160 mm – 6 ¹ / ₄ "	CV 07-184-01
200 mm – 8"	CV 07-184-01
240 mm – 9 ¹ / ₂ "	CV 07-184-01
300 mm – 12"	CV 07-184-01

Atraumatische Pinzetten
Atraumatic tissue forceps
Pinces atraumatiques
Pinzas atraumáticas de disección
Pinze atraumatiche per dissezione



x



1:1



1:1



1:1



1:1



1:1

DE BAKEY

	x = 1.2 mm	x = 1.5 mm	x = 1.8 mm	x = 2.0 mm	x = 2.8 mm
160 mm – 6 ¹ / ₄ "	CV 07-185-01	CV 07-186-01	CV 07-187-01	CV 07-188-01	CV 07-189-01
200 mm – 8"	CV 07-185-02	CV 07-186-02	CV 07-187-02	CV 07-188-02	CV 07-189-02
240 mm – 9 ¹ / ₂ "	CV 07-185-03	CV 07-186-03	CV 07-187-03	CV 07-188-03	CV 07-189-03

FIZZA SURGICAL

Atraumatische Pinzetten
Atraumatic tissue forceps
Pinces atraumatiques
Pinzas atraumáticas de disección
Pinze atraumatiche per dissezione

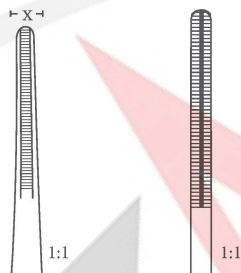

	x = 2.5 mm	x = 3.0 mm
150 mm – 6"	CV 07-190-01	CV 07-191-01
200 mm – 8"	CV 07-190-02	CV 07-191-02
240 mm – 9½"	CV 07-190-03	CV 07-191-03

Stainless



	x = 2.5 mm	x = 2.8 mm
150 mm – 6"	CV 07-195-01	CV 07-196-01
200 mm – 8"	CV 07-195-02	CV 07-196-02
240 mm – 9½"	CV 07-195-03	CV 07-196-03

Titanium



Bulldogklemmen mit Ringgriff Ring
handle Bulldog clamps
Clamps Bulldog, manches à anneaux
Clamps Bulldog, mangos con anillos
Pinze Bulldog con manici ad anelli



POTTS

200 mm – 8"	220 mm – 8 ³ / ₄ "	200 mm – 8"	220 mm – 8 ³ / ₄ "
CV 07-200-01	CV 07-200-02	CV 07-201-01	CV 07-201-02

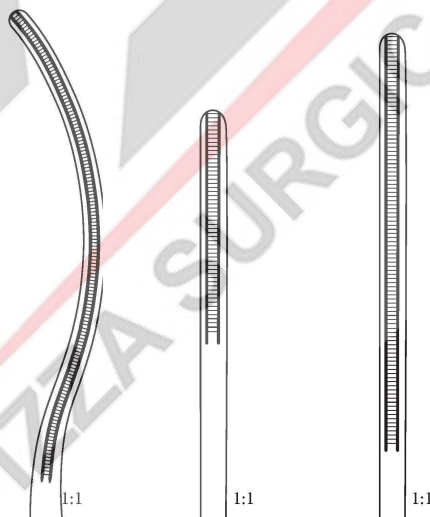
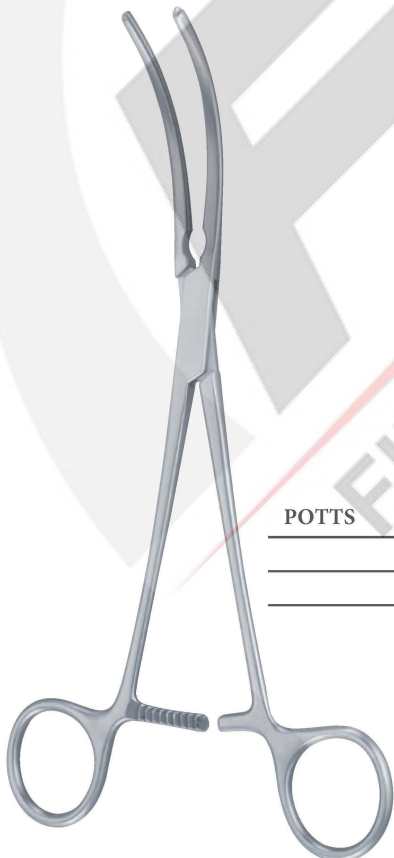

POTTS

220 mm – 8 ³ / ₄ "	210 mm – 8 ¹ / ₄ "	220 mm – 8 ³ / ₄ "
CV 07-202-01	CV 07-202-02	CV 07-202-03

Gefäßklemmen
Vascular forceps
Pinces vasculaires
Pinzas vasculares
Pinze vascolari

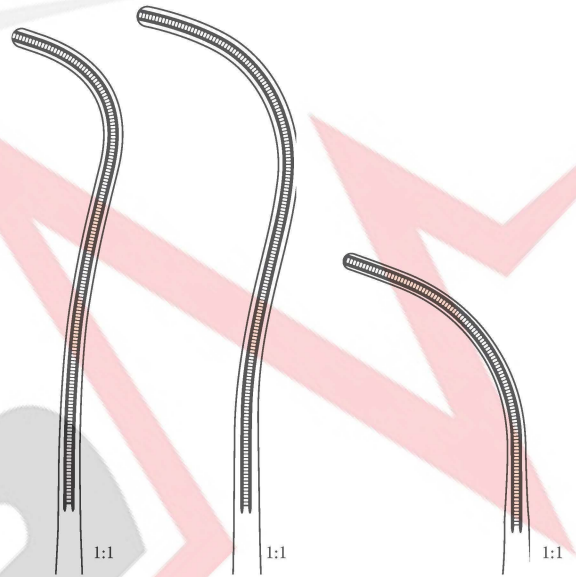
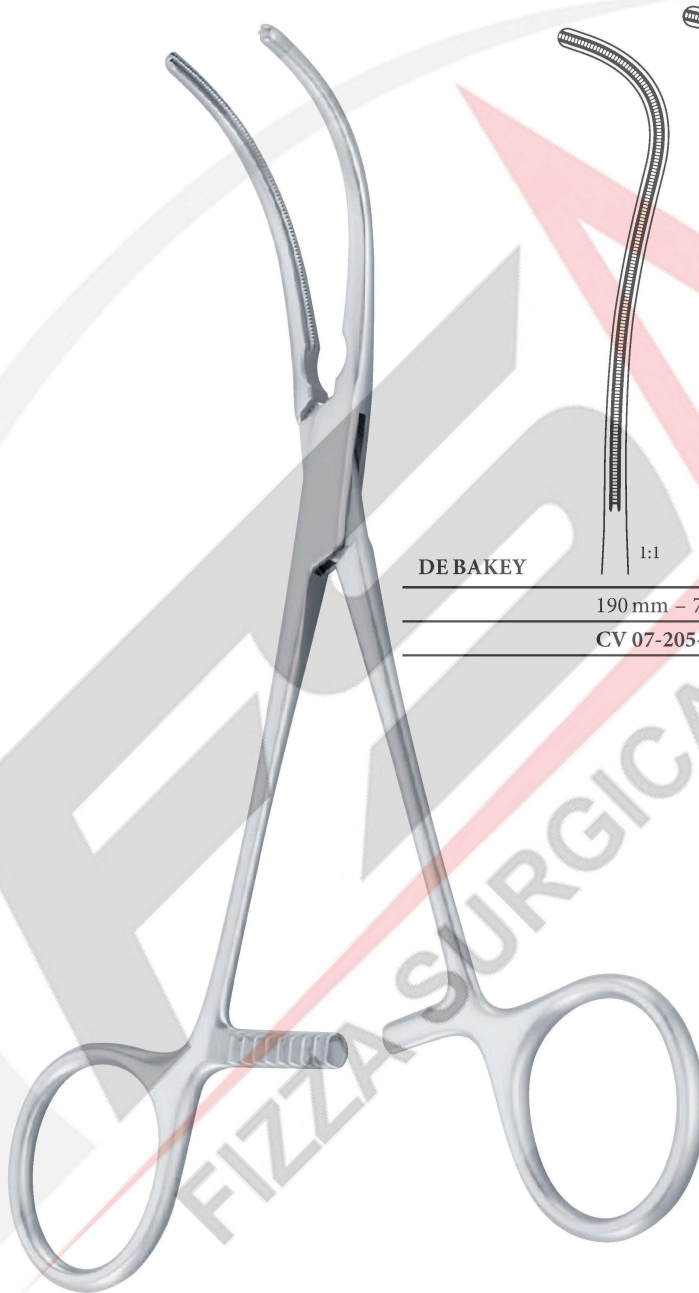

DEBAKEY

190 mm – 7½"	230 mm – 9"	160 mm – 6¼"
CV 07-205-01	CV 07-205-02	CV 07-205-03

Gefäßklemmen
Vascular forceps
Pinces vasculaires
Pinzas vasculares
Pinze vascolari

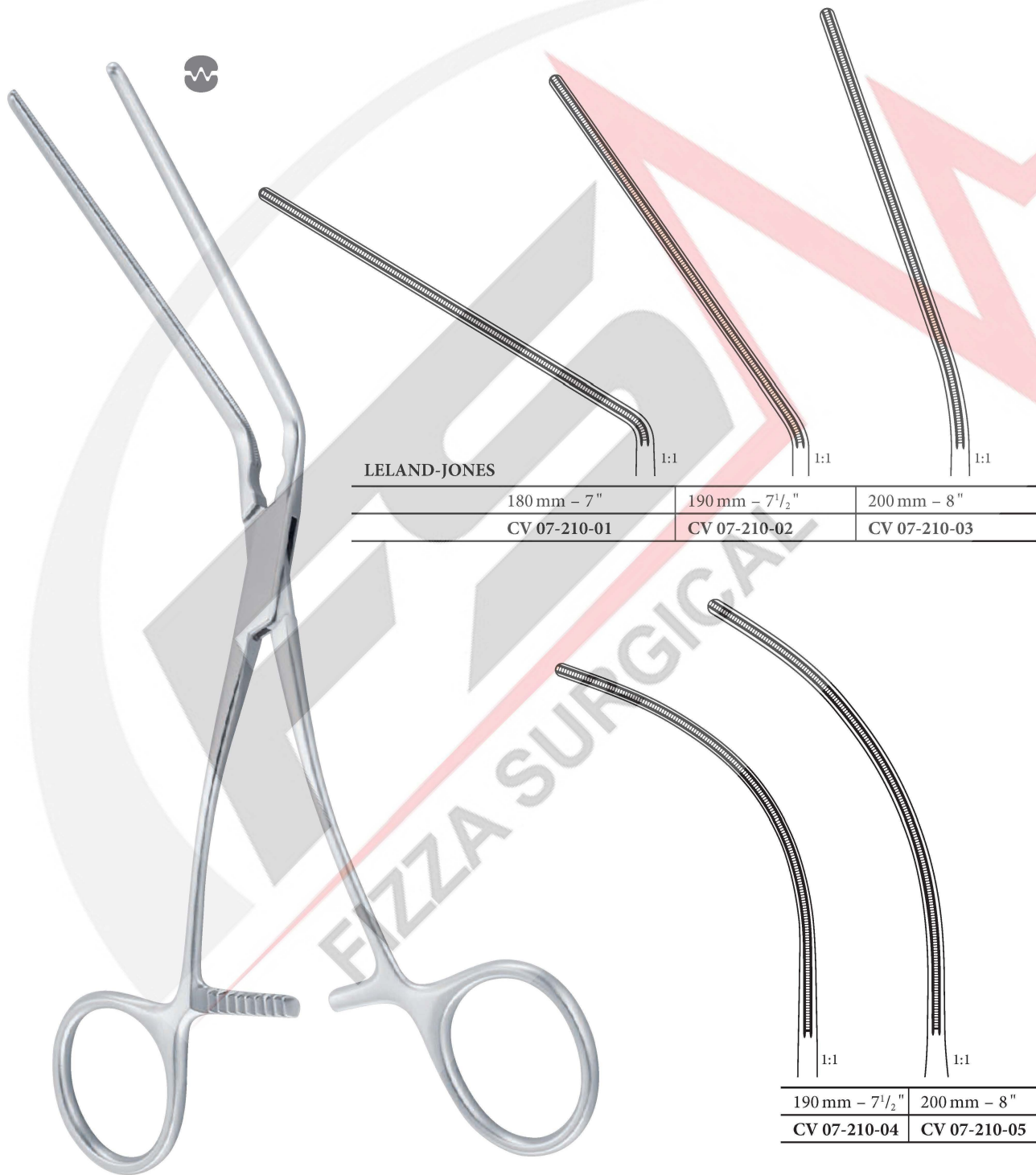

LELAND-JONES

180 mm – 7"	190 mm – 7½"	200 mm – 8"
CV 07-210-01	CV 07-210-02	CV 07-210-03

190 mm – 7½"	200 mm – 8"
CV 07-210-04	CV 07-210-05

Gefäßklemmen
Vascular forceps
Pinces vasculaires
Pinzas vasculares
Pinze vascolari

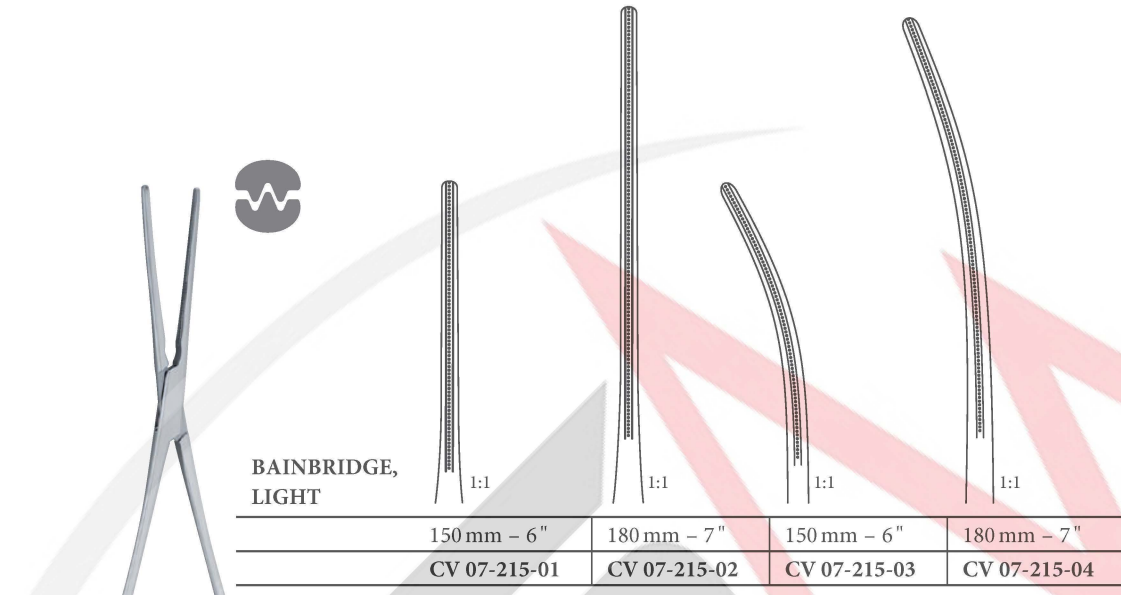

**BAINBRIDGE,
LIGHT**

150 mm – 6"	180 mm – 7"	150 mm – 6"	180 mm – 7"
CV 07-215-01	CV 07-215-02	CV 07-215-03	CV 07-215-04

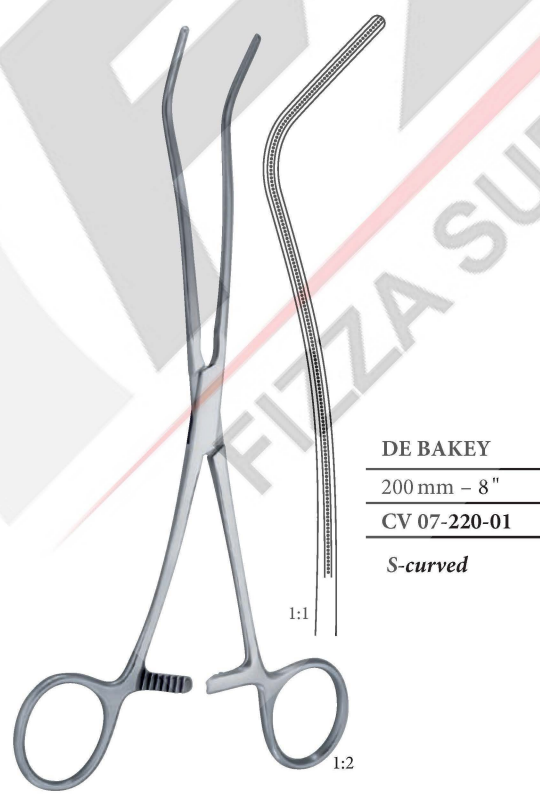

DE BAKEY
200 mm – 8"
CV 07-220-01
S-curved



OVUM
250 mm – 9"
CV 07-221-01

Gefäßklemmen
Vascular forceps
Pinces vasculaires
Pinzas vasculares
Pinze vascolari

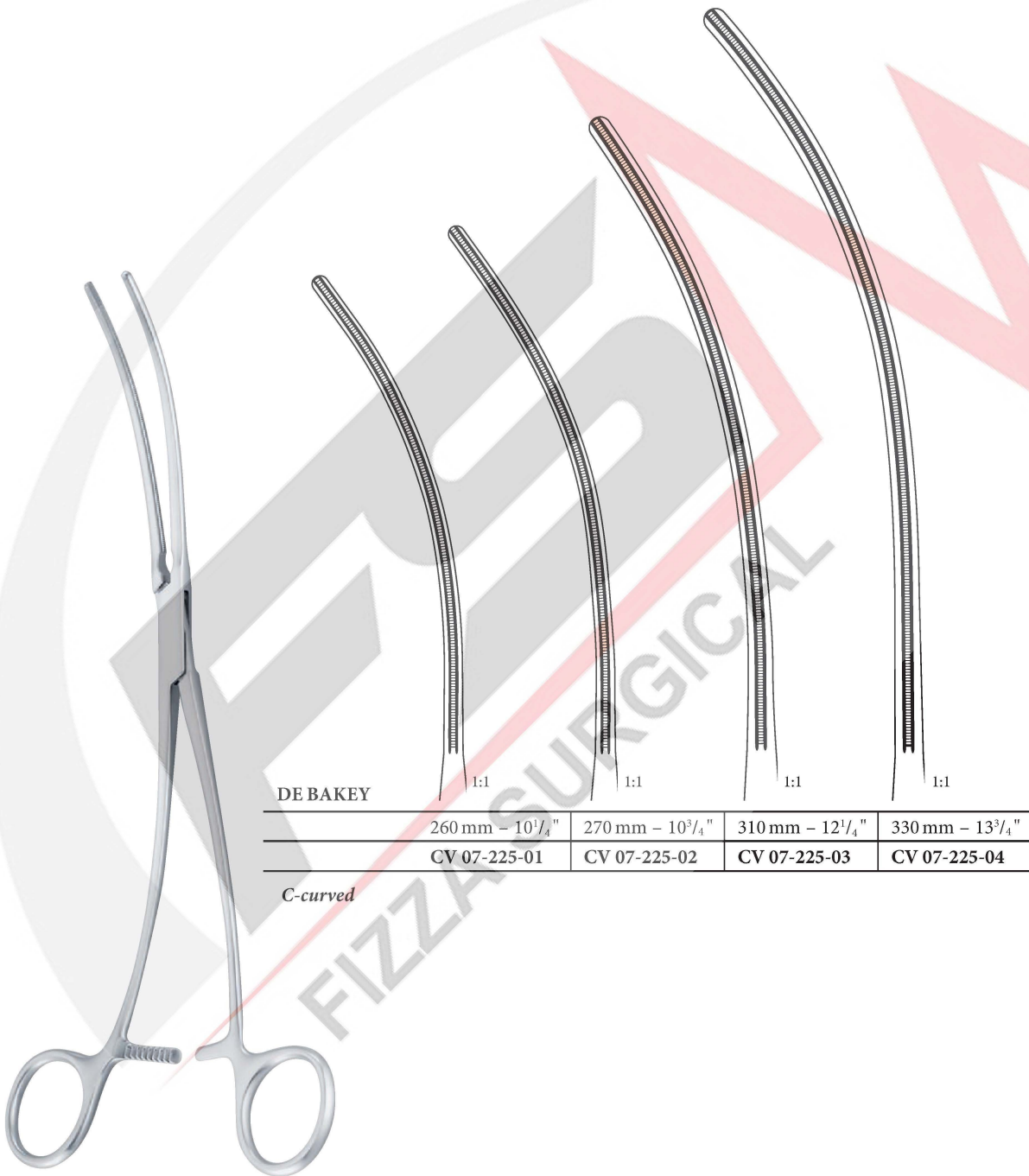

DE BAKKEY

260 mm – 10 ¹ / ₄ "	270 mm – 10 ³ / ₄ "	310 mm – 12 ¹ / ₄ "	330 mm – 13 ³ / ₄ "
CV 07-225-01	CV 07-225-02	CV 07-225-03	CV 07-225-04

C-curved

Gefäßklemmen
Vascular forceps
Pinces vasculaires
Pinzas vasculares
Pinze vascolari



DE BAKKEY	
280 mm – 11"	300 mm – 11 ³ / ₄ "
CV 07-230-01	CV 07-231-01

S-curved

Gefäßklemmen
Vascular forceps
Pinces vasculaires
Pinzas vasculares
Pinze vascolari

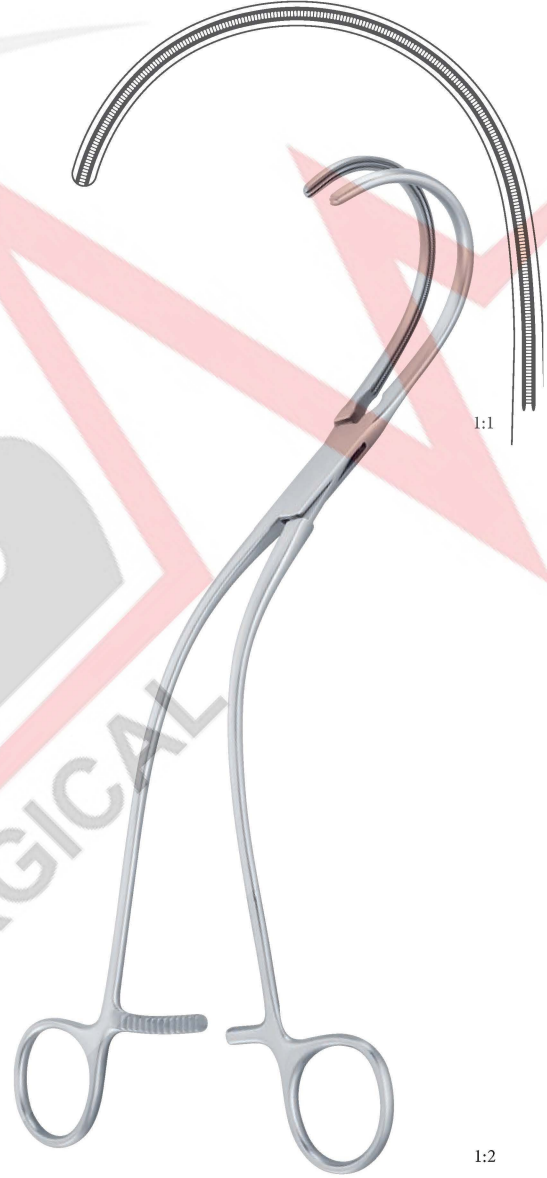

Weber

260 mm – 10¹/₄"

CV 07-235-01

curved left

1:2

260 mm – 10¹/₄"

CV 07-236-01

curved right

1:2

Gefäßklemmen
Vascular forceps
Pinces vasculaires
Pinzas vasculares
Pinze vascolari

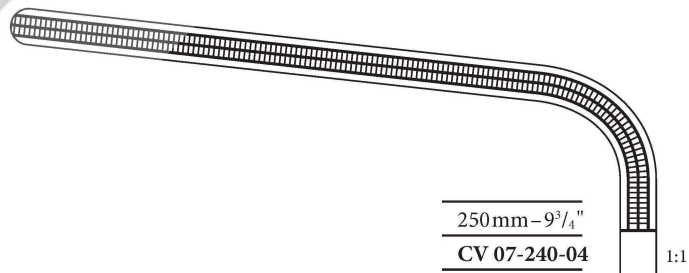
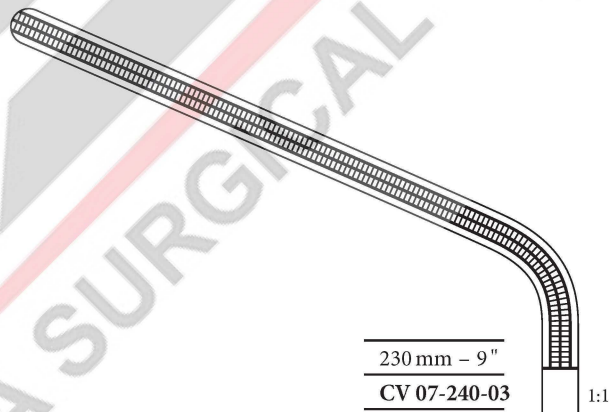
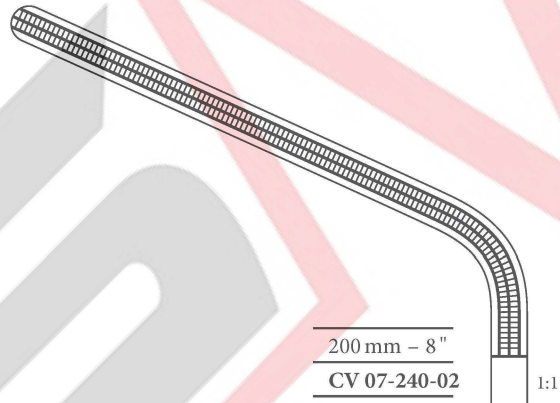
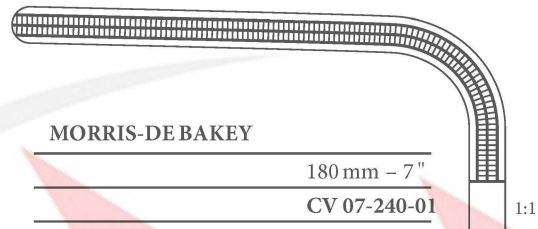

Gefäßklemmen
Vascular forceps
Pinces vasculaires
Pinzas vasculares
Pinze vascolari

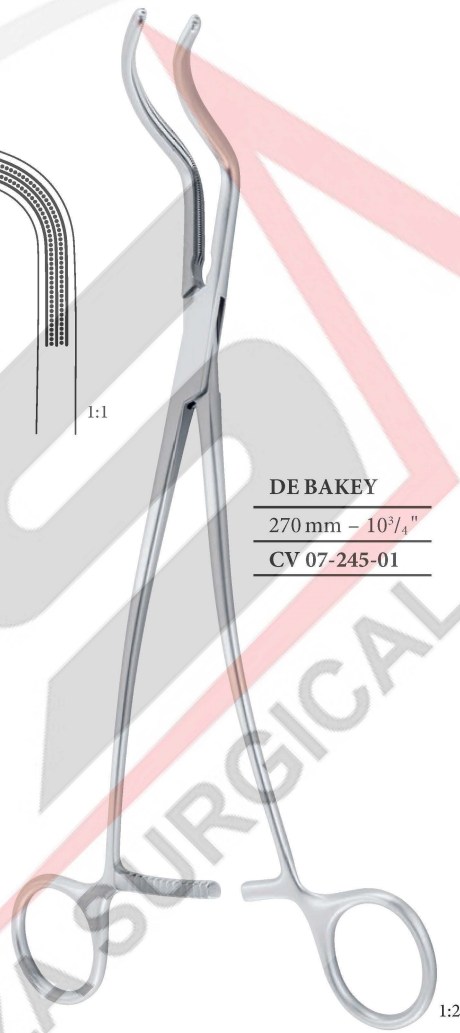
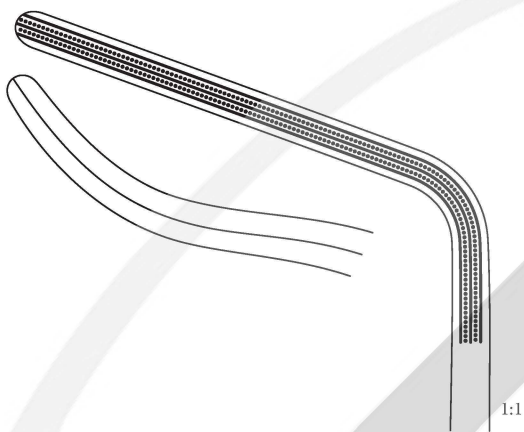

DE BAKKEY

270 mm – 10³/₄"

CV 07-245-01

Gefäßklemmen
Vascular forceps
Pinces vasculaires
Pinzas vasculares
Pinze vascolari

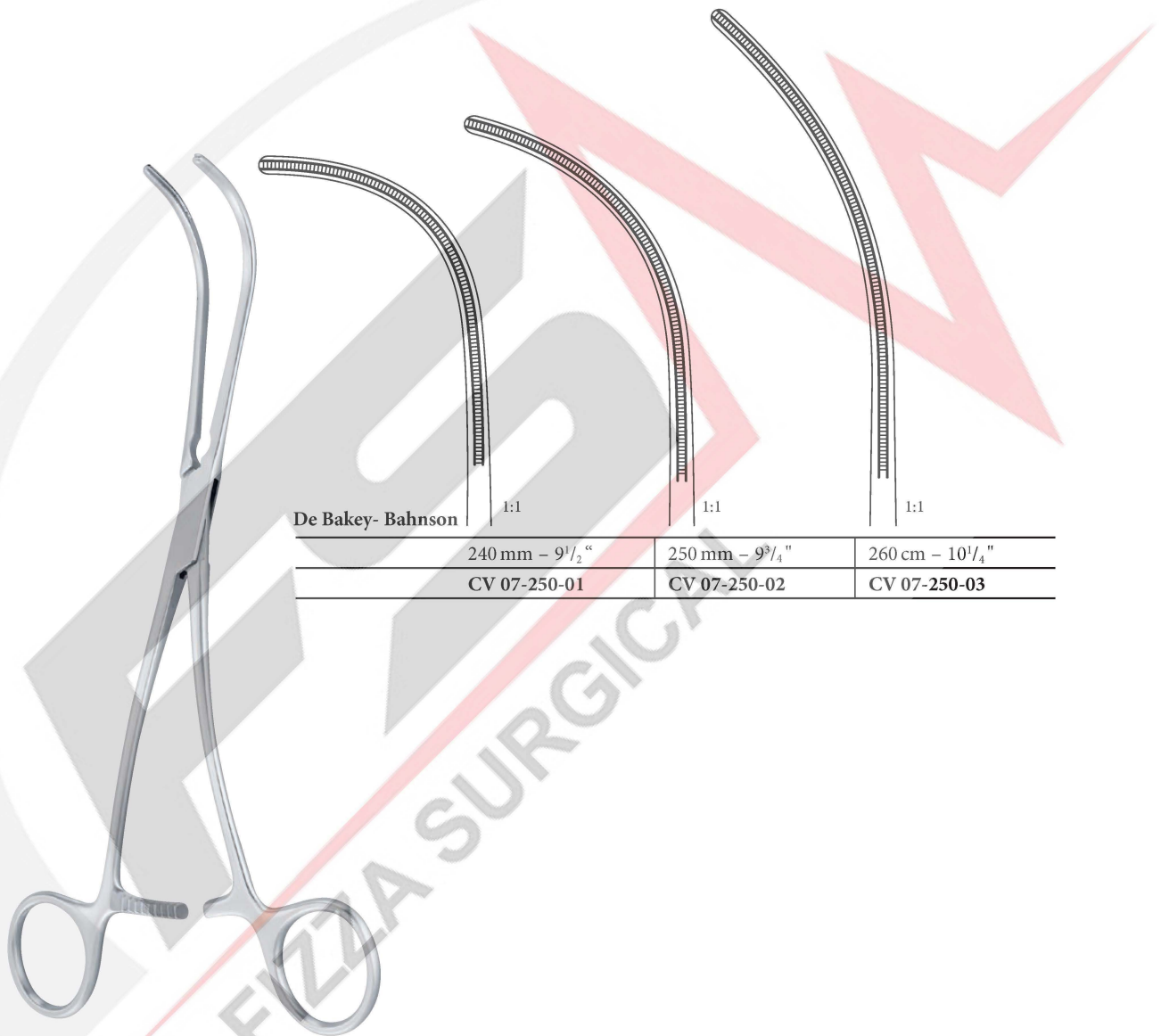

De Bakey- Bahnsen

1:1

1:1

1:1

240 mm – 9¹/₂“

250 mm – 9³/₄“

260 cm – 10¹/₄“

CV 07-250-01

CV 07-250-02

CV 07-250-03

Gefäßklemmen
Vascular forceps
Pinces vasculaires
Pinzas vasculares
Pinze vascolari



DE BAKEY-SEMB

240 mm – 9¹/₂"

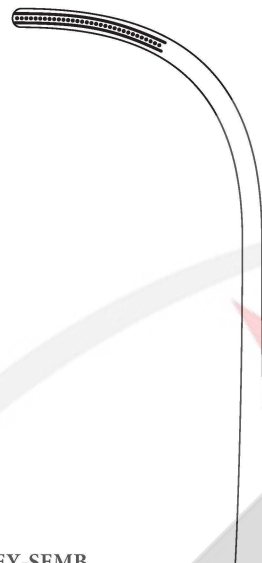

1:1

CV 07-255-01

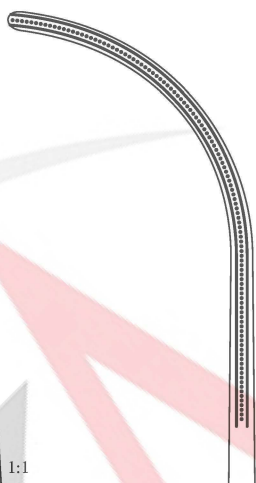

1:1

CV 07-255-02

1:2



DE BAKEY

250 mm – 10"

CV 07-260-01

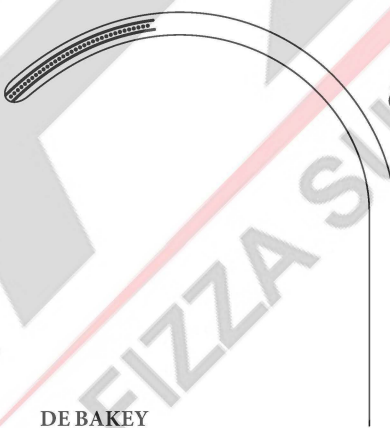

1:1

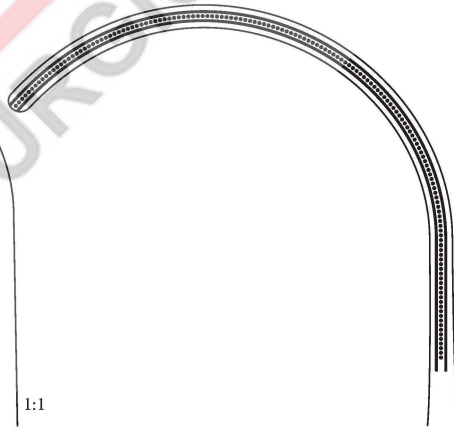

1:1

260 mm – 10¹/₄"

CV 07-260-02

Gefäßklemmen
Vascular forceps
Pinces vasculaires
Pinzas vasculares
Pinze vascolari

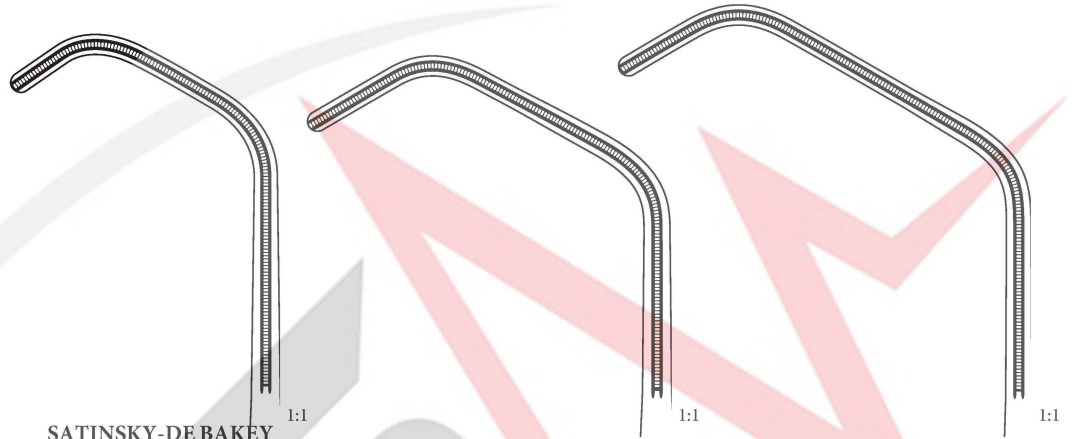

SATINSKY-DE BAKEY

205 mm – 8"	240 mm – 9 ³ / ₄ "	250 mm – 10"
CV 07-265-01	CV 07-265-02	CV 07-265-03

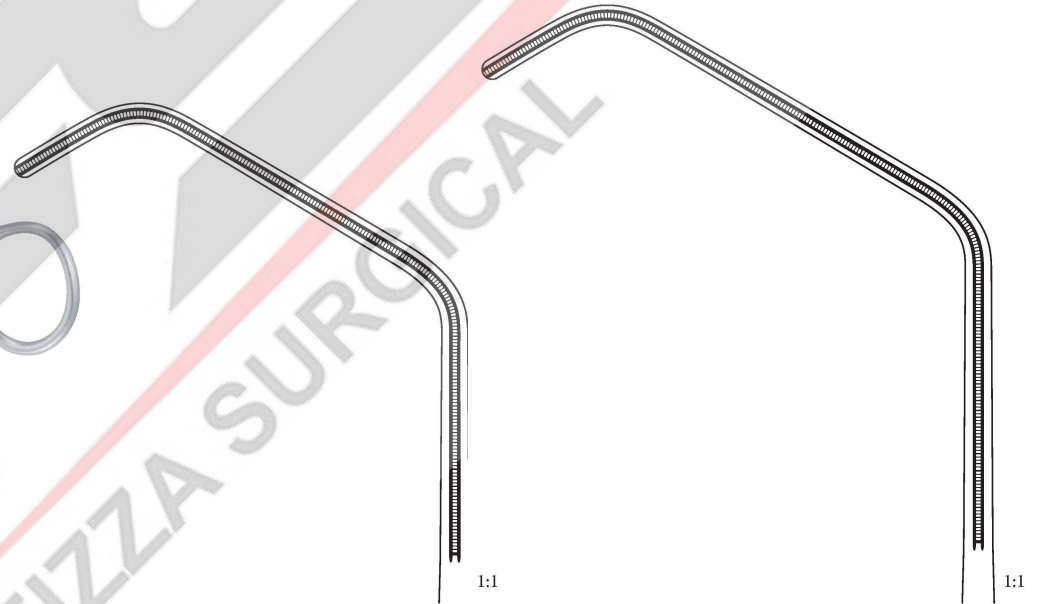

265 mm – 10 ¹ / ₂ "	275 mm – 10 ³ / ₄ "
CV 07-265-04	CV 07-265-05

Gefäßklemmen
Vascular forceps
Pinces vasculaires
Pinzas vasculares
Pinze vascolari

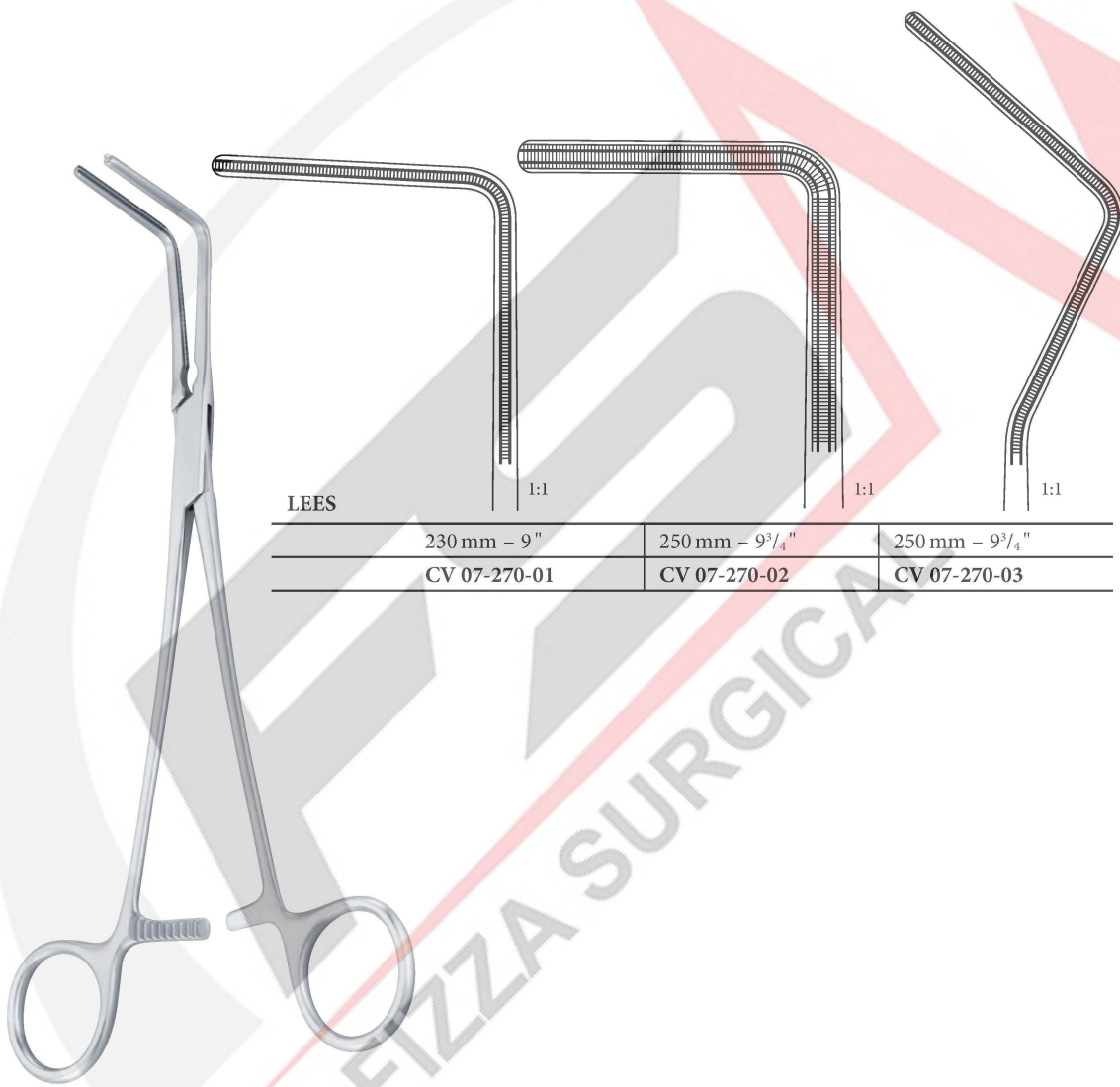

LEES	230 mm – 9"	250 mm – 9 ³ / ₄ "	250 mm – 9 ³ / ₄ "
	CV 07-270-01	CV 07-270-02	CV 07-270-03

Gefäßklemmen
Vascular forceps
Pinces vasculaires
Pinzas vasculares
Pinze vascolari

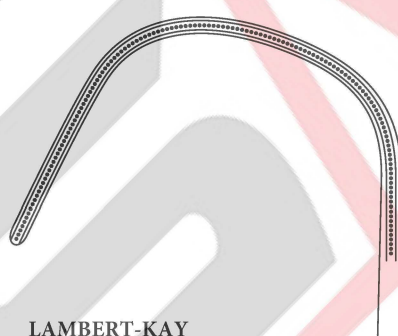

1:1

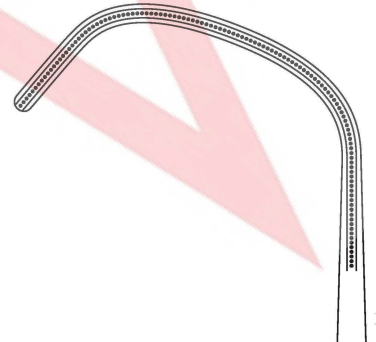

1:1

LAMBERT-KAY

200 mm – 8"

CV 07-275-01

CV 07-275-02

Gefäßklemmen
Vascular forceps
Pinces vasculaires
Pinzas vasculares
Pinze vascolari



DE BAKY

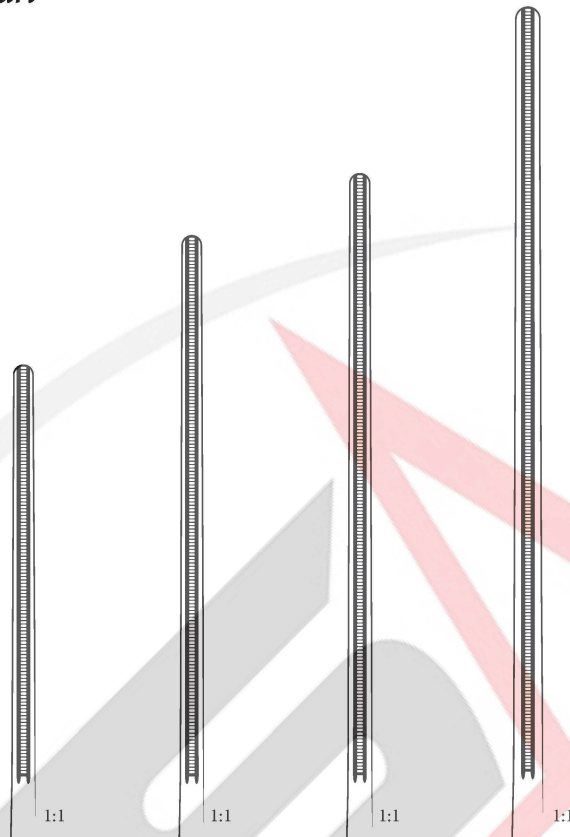

215 mm – 8½"	230 mm – 9"	270 mm – 10¾"	315 mm – 12½"
CV 07-280-01	CV 07-280-02	CV 07-280-03	CV 07-280-04

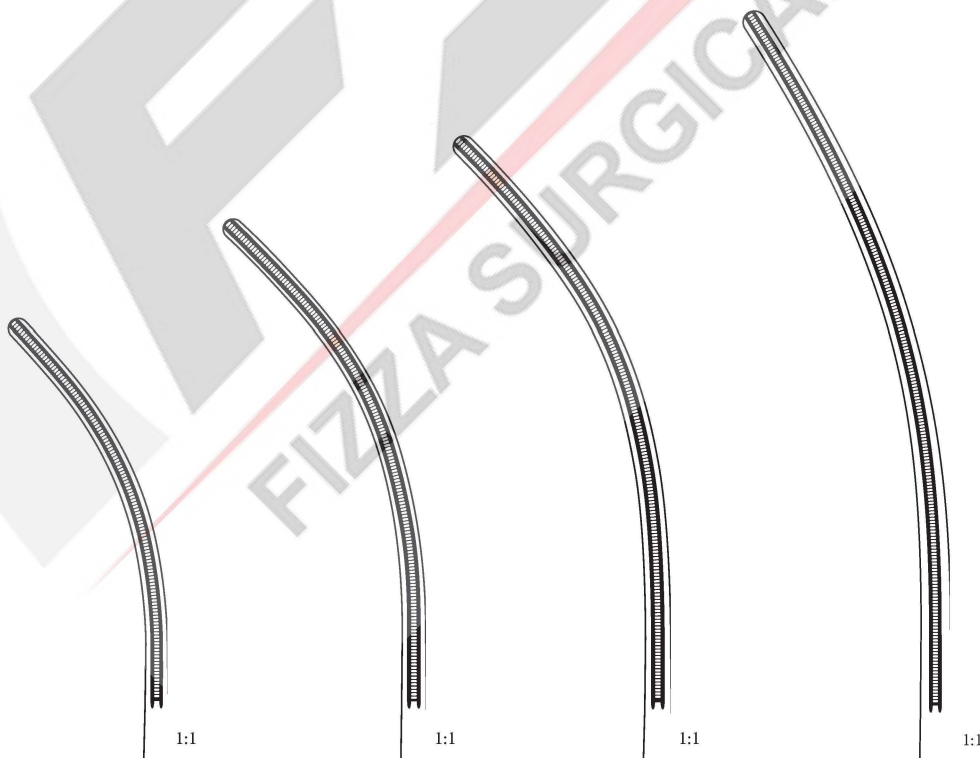

215 mm – 8½"	230 mm – 9"	270 mm – 10¾"	315 mm – 12½"
CV 07-281-01	CV 07-281-02	CV 07-281-03	CV 07-281-04

Gefäßklemmen
Vascular forceps
Pinces vasculaires
Pinzas vasculares
Pinze vascolari

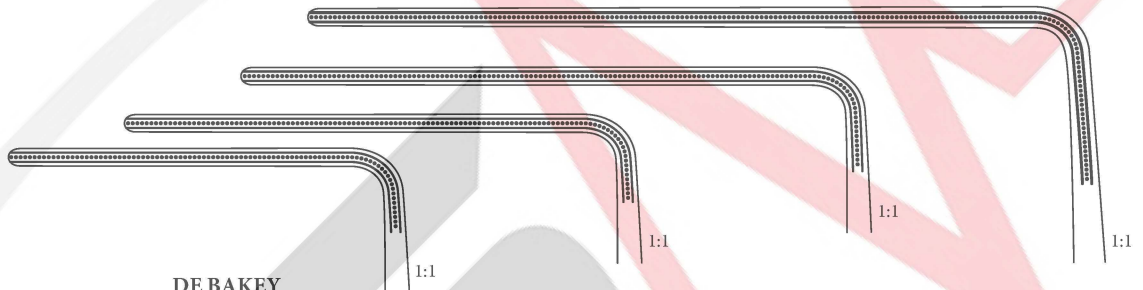

DE BAKKEY

180 mm – 7"	190 mm – 7½"	230 mm – 9"	270 mm – 10¾"
CV 07-285-01	CV 07-285-02	CV 07-285-03	CV 07-285-04

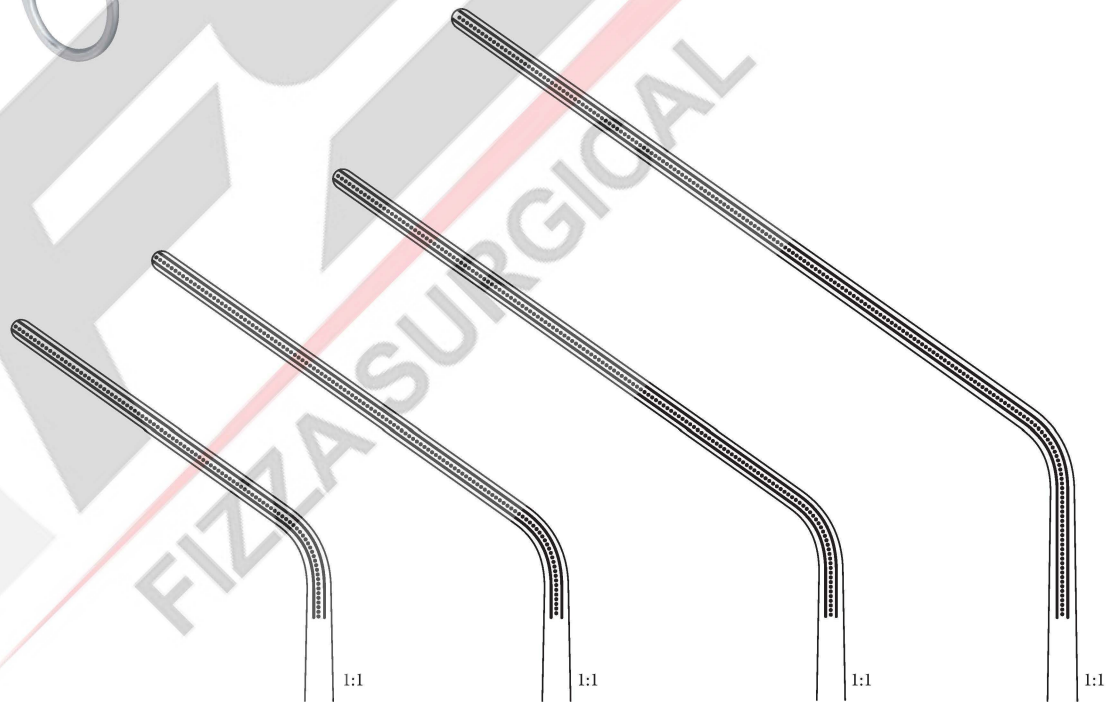

200 mm – 8"	210 mm – 8¼"	250 mm – 9¾"	300 mm – 12"
CV 07-286-01	CV 07-286-02	CV 07-286-03	CV 07-286-04

Gefäßklemmen
Vascular forceps
Pinces vasculaires
Pinzas vasculares
Pinze vascolari

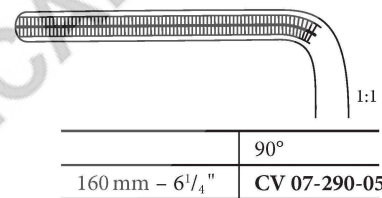
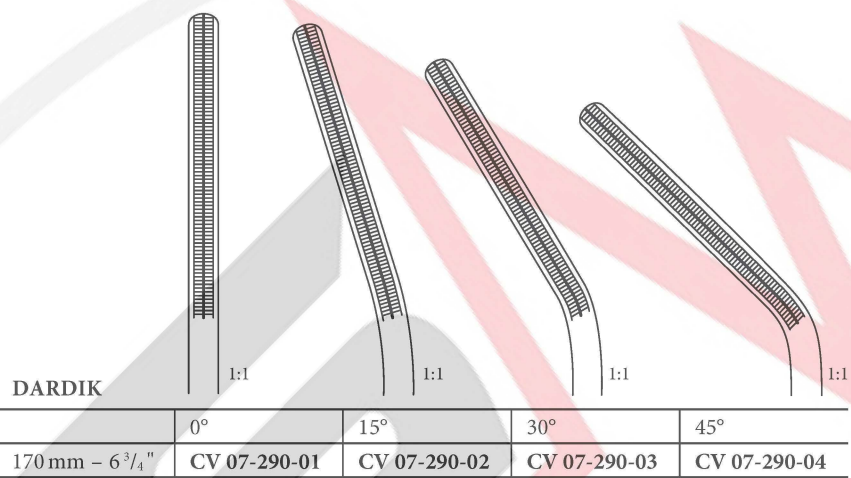

Gefäßklemmen
Vascular forceps
Pinces vasculaires
Pinzas vasculares
Pinze vascolari

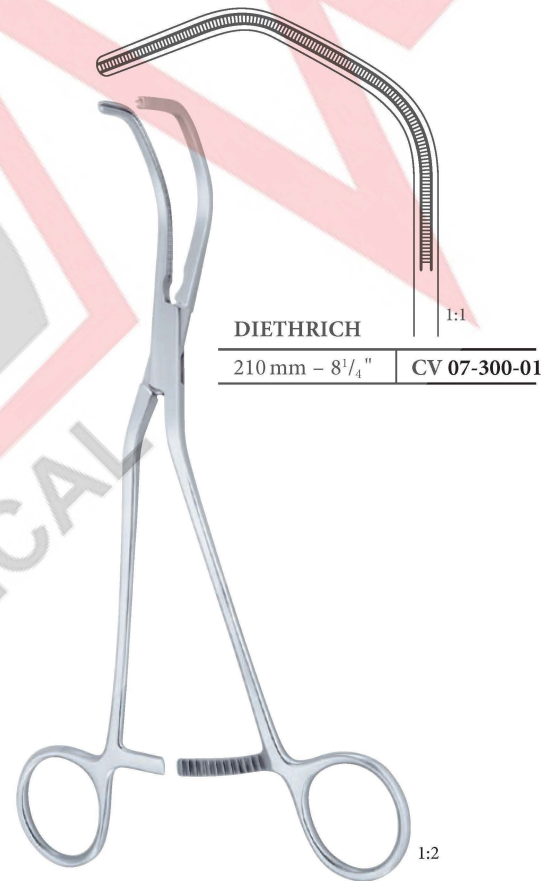
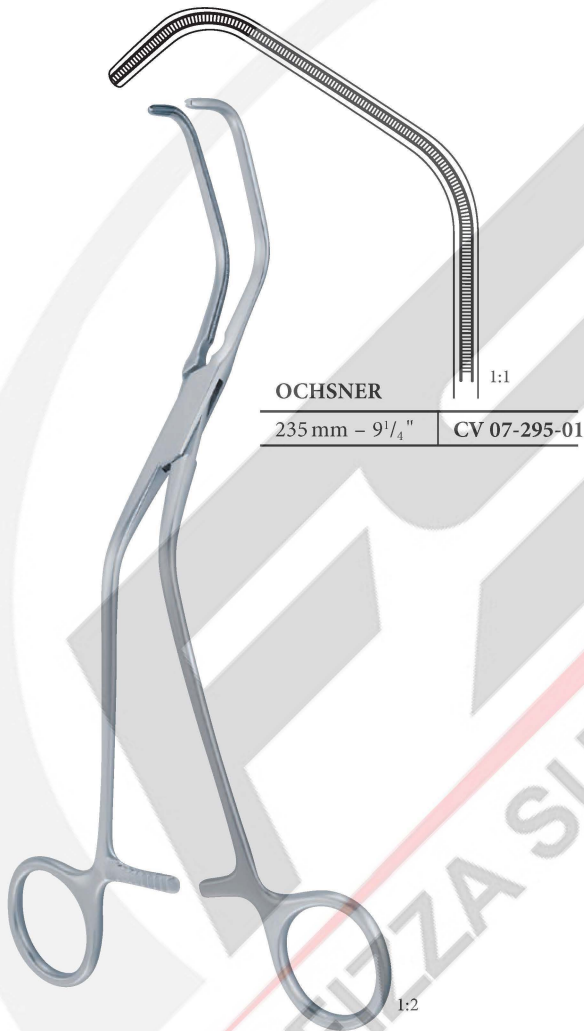

Gefäßklemmen
Vascular forceps
Pinces vasculaires
Pinzas vasculares
Pinze vascolari

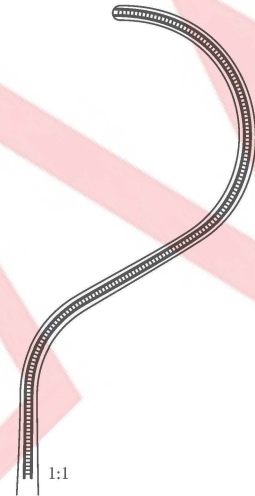
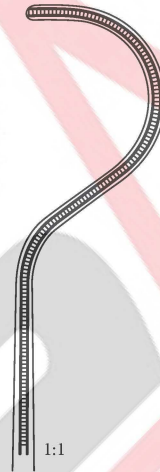
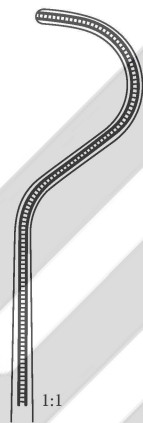
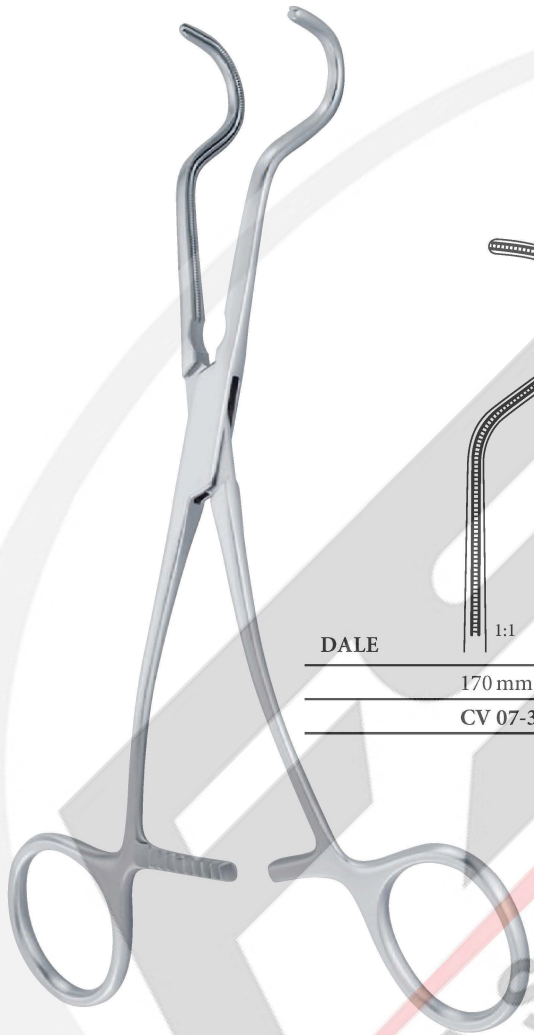

DALE

170 mm - 6 ³ / ₄ "	175 mm - 7"	185 mm - 7 ¹ / ₄ "
CV 07-305-01	CV 07-305-02	CV 07-305-03

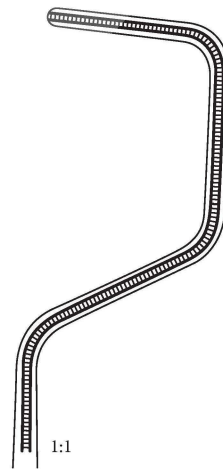

185 mm - 7 ¹ / ₄ "
CV 07-305-04

Gefäßklemmen
Vascular forceps
Pinces vasculaires
Pinzas vasculares
Pinze vascolari

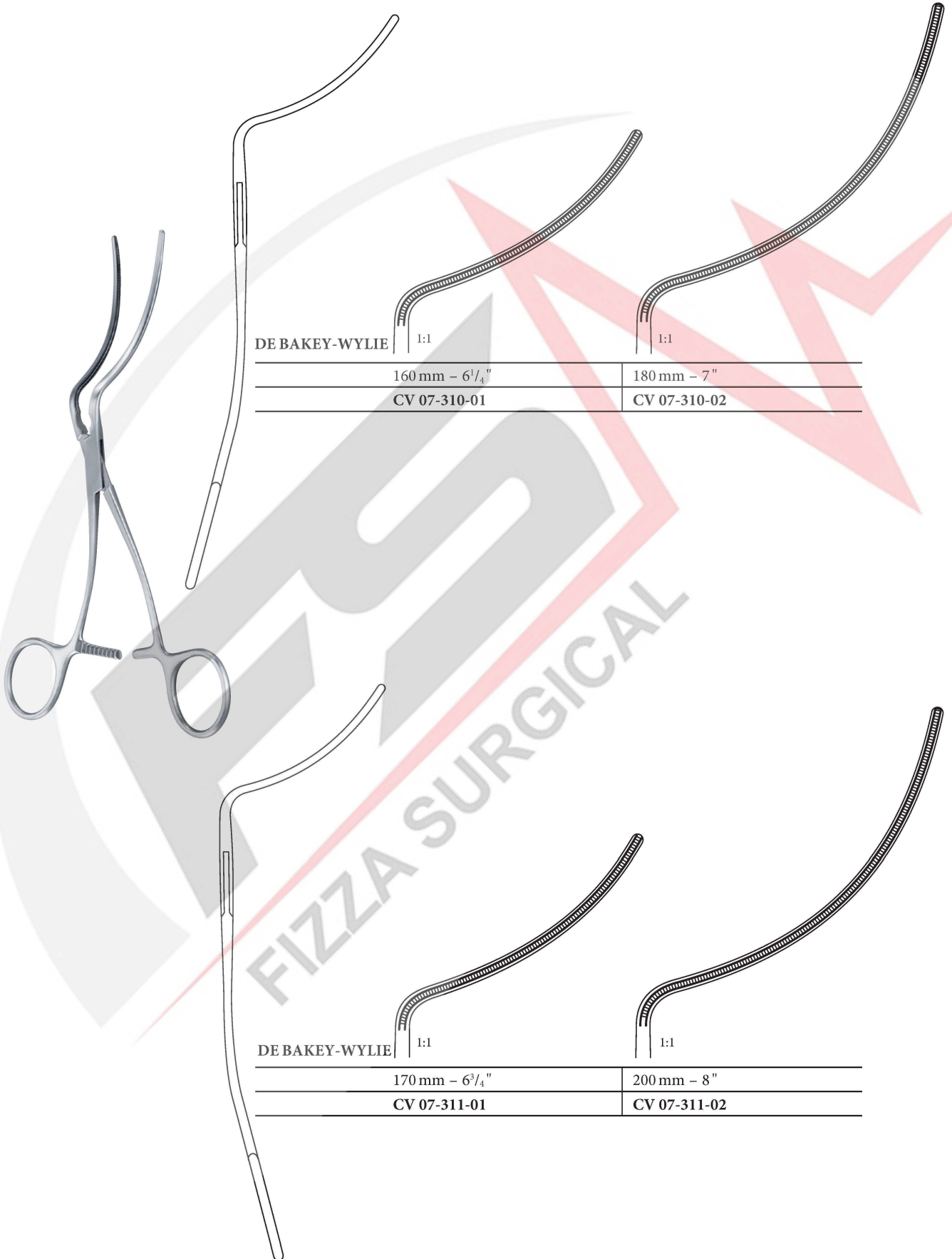

DE BAKEY-WYLIE

1:1

160 mm – 6¹/₄"

CV 07-310-01

1:1

180 mm – 7"

CV 07-310-02

DE BAKEY-WYLIE

1:1

170 mm – 6³/₄"

CV 07-311-01

1:1

200 mm – 8"

CV 07-311-02

Gefäßklemmen
Vascular forceps
Pinces vasculaires
Pinzas vasculares
Pinze vascolari



GREGORY

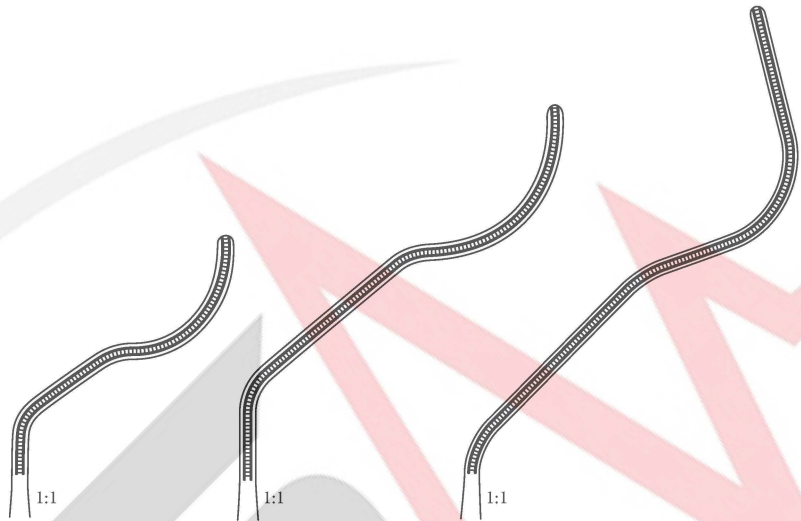

140 mm – 5 1/2"	160 mm – 6 1/4"	180 mm – 7"
CV 07-315-01	CV 07-315-02	CV 07-315-03



JAVID

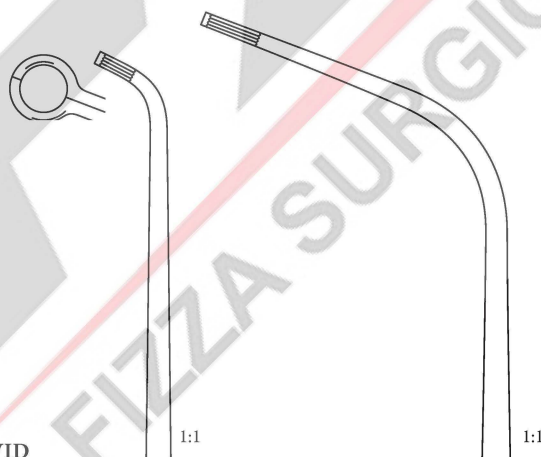

160 mm – 6 1/4"	190 mm – 7 1/2"
CV 07-320-01	CV 07-320-02

Gefäßklemmen
Vascular forceps
Pinces vasculaires
Pinzas vasculares
Pinze vascolari

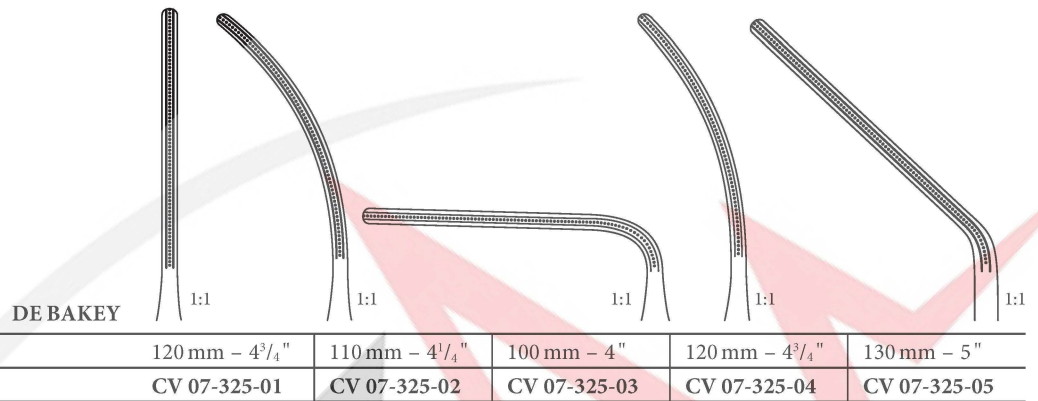

DE BAKEY	120 mm – 4 ³ / ₄ "	110 mm – 4 ¹ / ₄ "	100 mm – 4"	120 mm – 4 ³ / ₄ "	130 mm – 5"
	CV 07-325-01	CV 07-325-02	CV 07-325-03	CV 07-325-04	CV 07-325-05

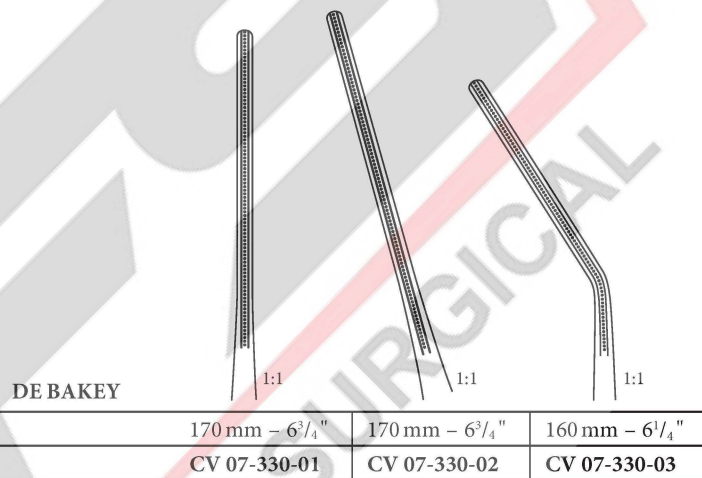

DE BAKEY	170 mm – 6 ³ / ₄ "	170 mm – 6 ³ / ₄ "	160 mm – 6 ¹ / ₄ "
	CV 07-330-01	CV 07-330-02	CV 07-330-03

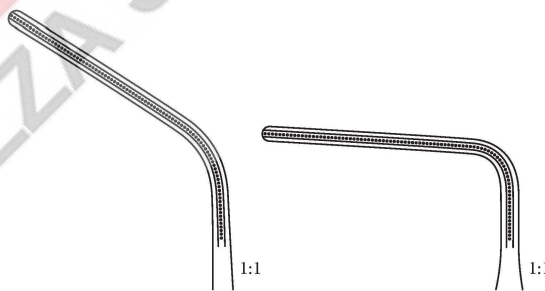







150 mm – 6"	140 mm – 5 ¹ / ₂ "
CV 07-330-04	CV 07-330-05

Gefäßklemmen
Vascular forceps
Pinces vasculaires
Pinzas vasculares
Pinze vascolari



GLOVER

		
1:1	1:1	1:1
205 mm – 8"	220 mm – 8 ³ / ₄ "	260 mm – 10 ¹ / ₄ "
CV 07-335-01	CV 07-335-02	CV 07-335-03

		
1:1	1:1	1:1
205 mm – 8"	220 mm – 8 ³ / ₄ "	260 mm – 10 ¹ / ₄ "
CV 07-335-04	CV 07-335-05	CV 07-335-06
<i>Angled on flat</i>	<i>Angled on flat</i>	<i>Angled on flat</i>

Gefäßklemmen
Vascular forceps
Pinces vasculaires
Pinzas vasculares
Pinze vascolari



GLOVER

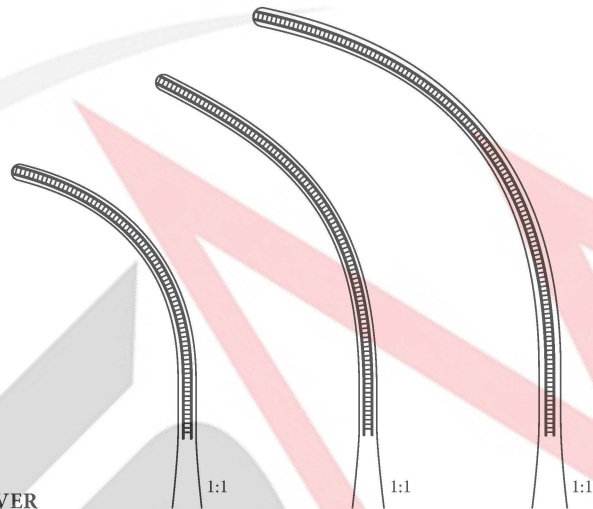

170 mm – 6 ³ / ₄ "	210 mm – 8 ¹ / ₄ "	240 mm – 9 ¹ / ₂ "
CV 07-340-01	CV 07-340-02	CV 07-340-03

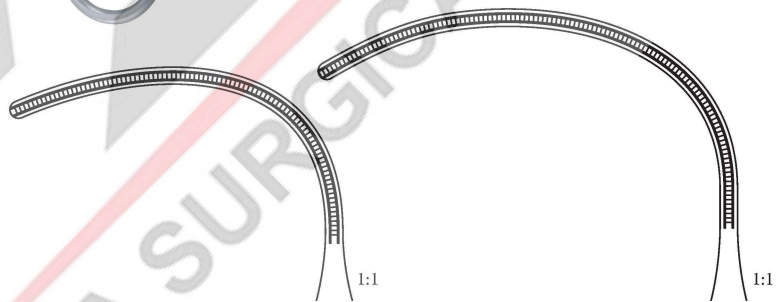

185 mm – 7 ¹ / ₄ "	220 mm – 8 ³ / ₄ "
CV 07-340-04	CV 07-340-05

Gefäßklemmen
Vascular forceps
Pinces vasculaires
Pinzas vasculares
Pinze vascolari

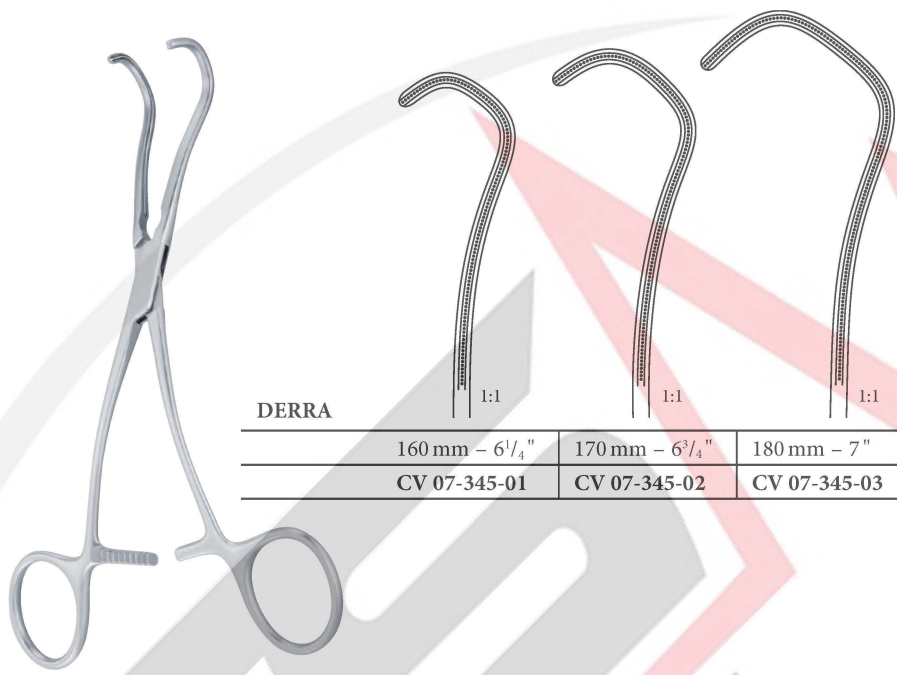

DERRA		
160 mm - 6 ¹ / ₄ "	170 mm - 6 ³ / ₄ "	180 mm - 7"
CV 07-345-01	CV 07-345-02	CV 07-345-03

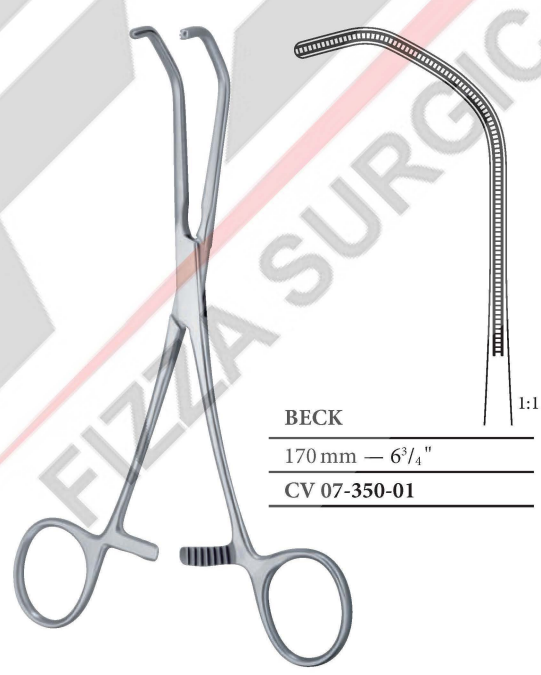

BECK
170 mm - 6 ³ / ₄ "
CV 07-350-01

Neonatal- u. Kinderklemmen, extra feine Modelle
Neonatal and children's clamps, extra delicate patterns
Pinces pour nouveaux-nés et enfants, modèles très fins
Pinzas para recién nacidos y niños, modelos muy finos
Pinze per bambini e neonati, molto fine

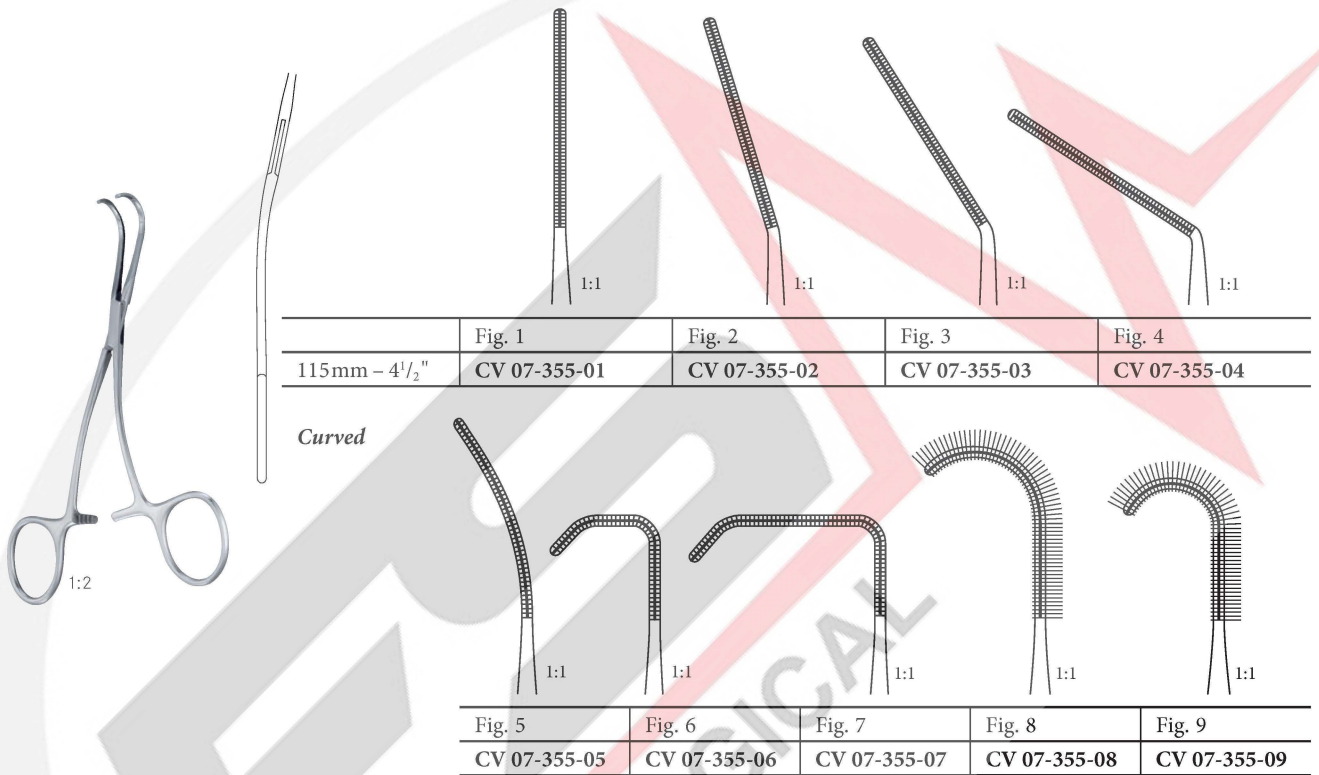

Neonatal- u. Kinderklemmen, extra feine Modelle
Neonatal and children's clamps, extra delicate patterns
Pinces pour nouveaux-nés et enfants, modèles très fins
Pinzas para recién nacidos y niños, modelos muy finos
Pinze per bambini e neonati, molto fine

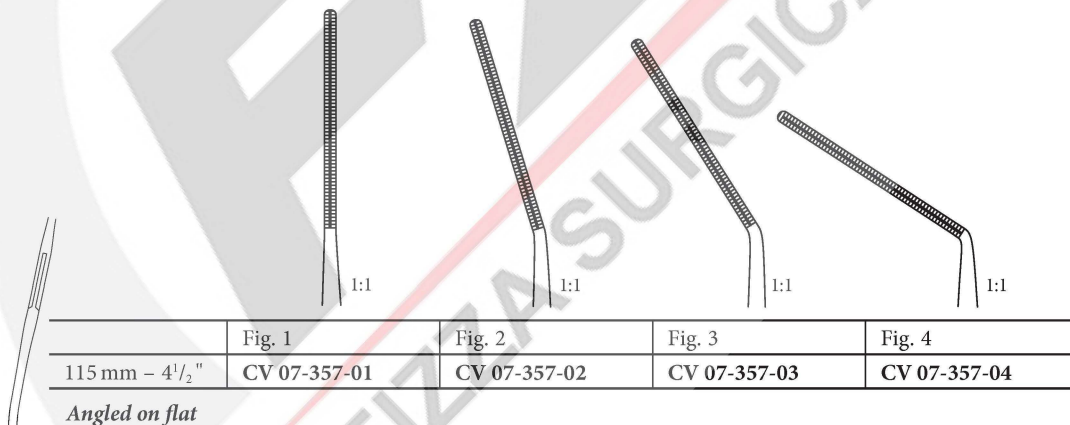
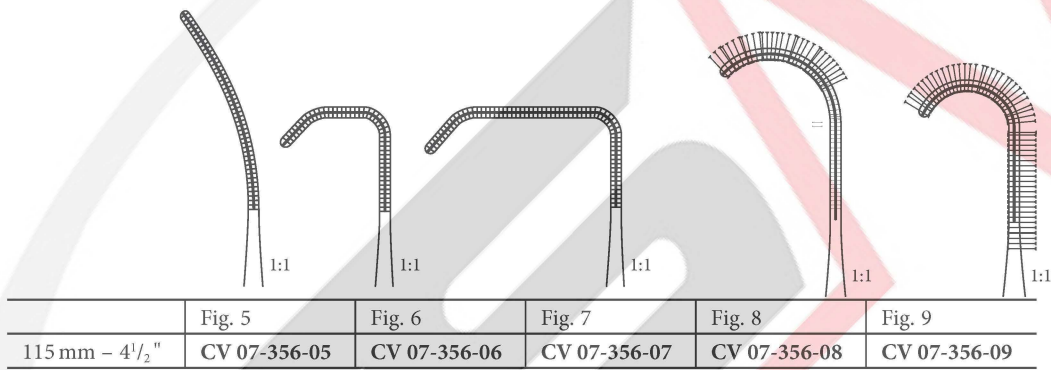
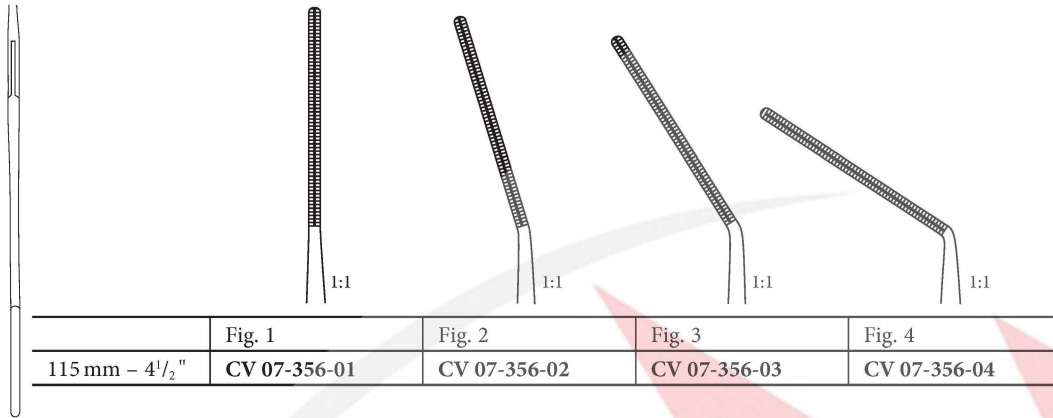

Angled on flat

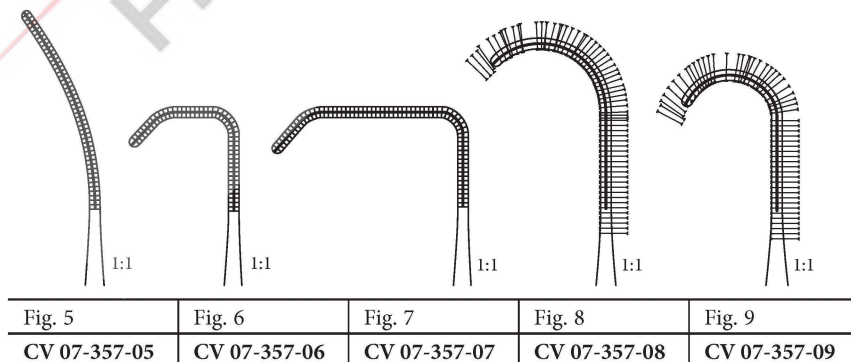

Neonatal- u. Kinderklemmen, extra feine Modelle
Neonatal and children's clamps, extra delicate patterns
Pinces pour nouveaux-nés et enfants, modèles très fins
Pinzas para recién nacidos y niños, modelos muy finos
Pinze per bambini e neonati, molto fine

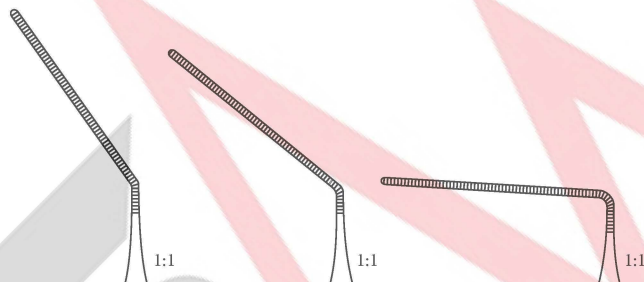

CASTANEDA

110 mm – 4 ³ / ₄ "			CV 07-360-01
130 mm – 5"	CV 07-361-01	CV 07-361-02	

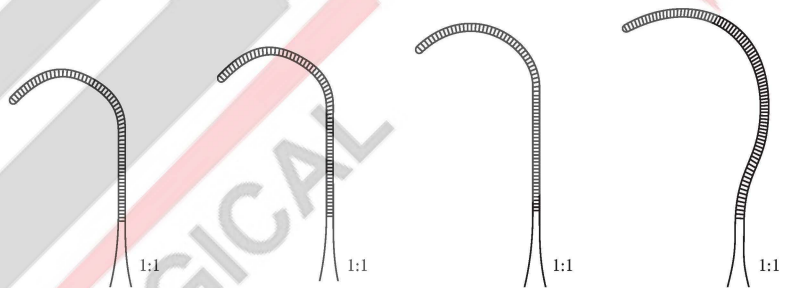

120 mm – 4 ³ / ₄ "	CV 07-362-01	CV 07-362-02	CV 07-362-31	
150 mm – 6"				CV 07-363-01

Gefäßklemmen
Vascular forceps
Pinces vasculaires
Pinzas vasculares
Pinze vascolari



COOLEY

120 mm – 4³/₄"

CV 07-365-01

CV 07-365-02

CV 07-365-03

straight

curved

S-curved

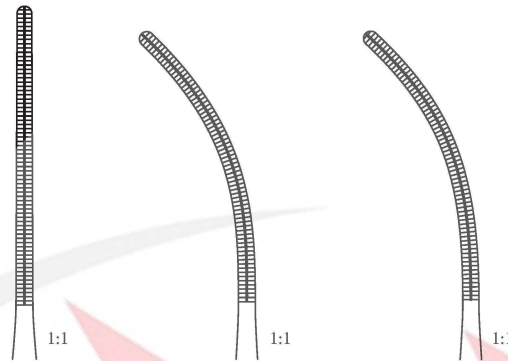

COOLEY

120 mm – 4³/₄"

CV 07-365-04

CV 07-365-05

CV 07-365-06

sideways angled

angled on flat

90° angled on flat

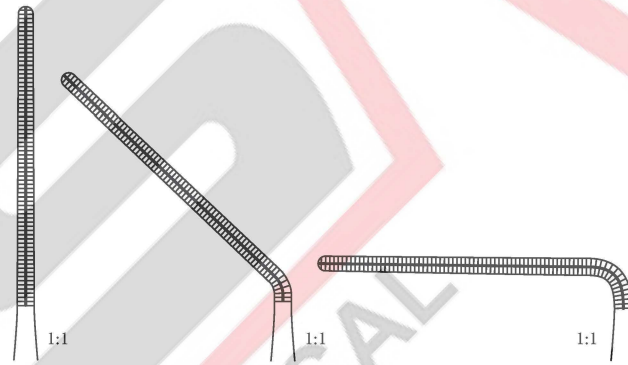

COOLEY

170 mm – 6³/₄"

CV 07-370-01

Sideways angled

1:1



Gefäßklemmen
Vascular forceps
Pinces vasculaires
Pinzas vasculares
Pinze vascolari

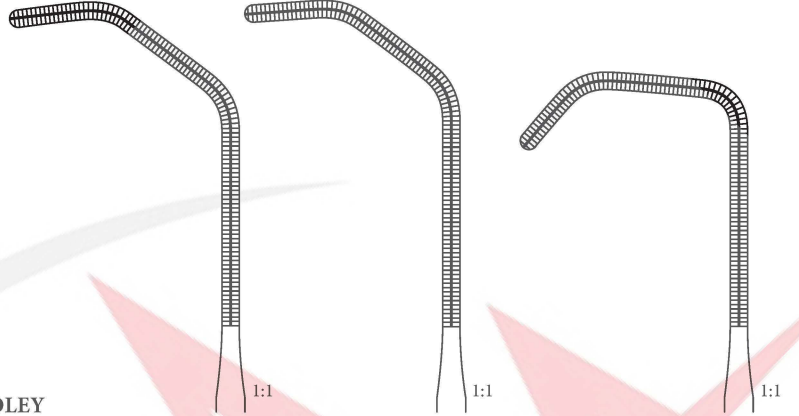

COOLEY		
175 mm – 7"	175 mm – 7"	165 mm – 6½"
CV 07-375-01	CV 07-375-02	CV 07-375-03

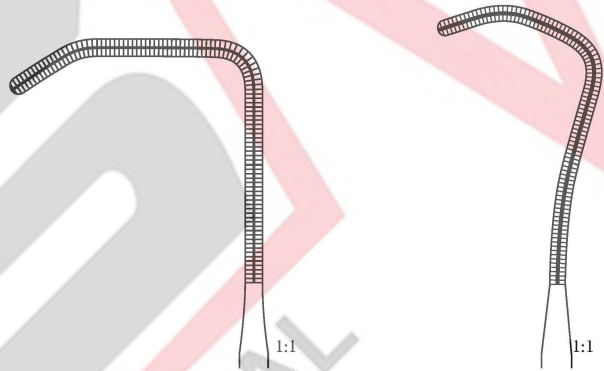

165 mm – 6½"	170 mm – 6¾"
CV 07-375-04	CV 07-375-05

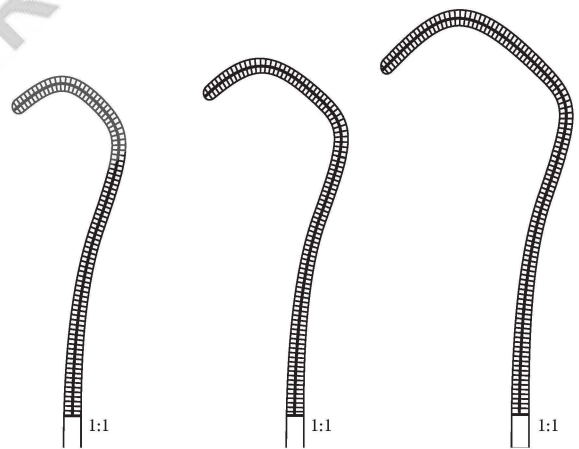
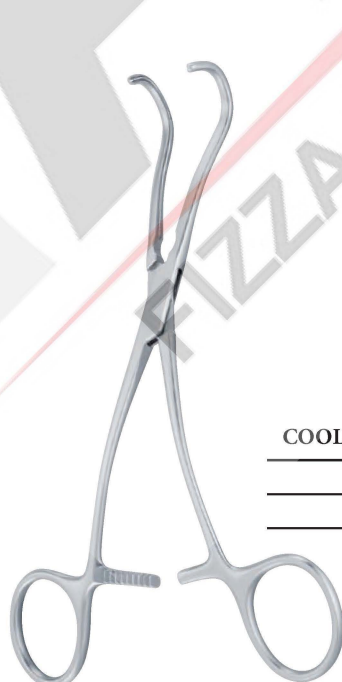

COOLEY-DERRA		
165 mm – 6½"	170 mm – 6¾"	175 mm – 7"
CV 07-380-01	CV 07-380-02	CV 07-380-03

Gefäßklemmen
Vascular forceps
Pinces vasculaires
Pinzas vasculares
Pinze vascolari



COOLEY-BECK

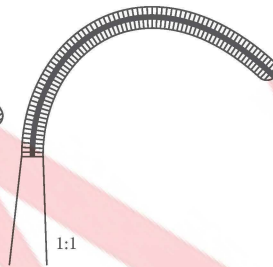
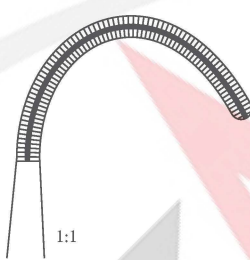

150 mm – 6"

155 mm – 6"

CV 07-385-01

CV 07-385-02



COOLEY

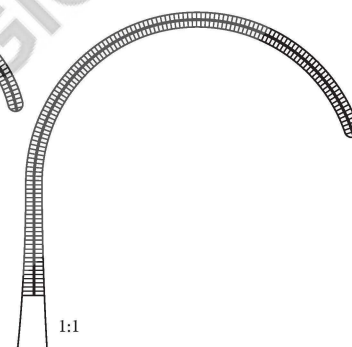
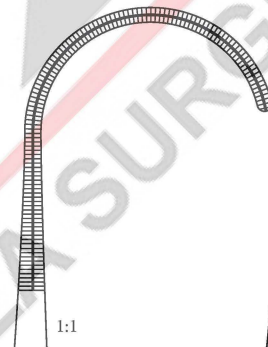

150 mm – 6"

160 mm – 6¹/₄"

CV 07-390-01

CV 07-390-02

Gefäßklemmen
Vascular forceps
Pinces vasculaires
Pinzas vasculares
Pinze vascolari

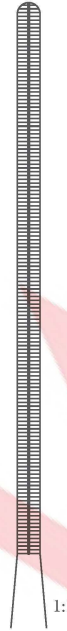

COOLEY

210 mm – 8 ¹ / ₄ "	250 mm – 9 ³ / ₄ "
CV 07-395-01	CV 07-395-02

Sidewards angled on flat *sidewards angled on flat*

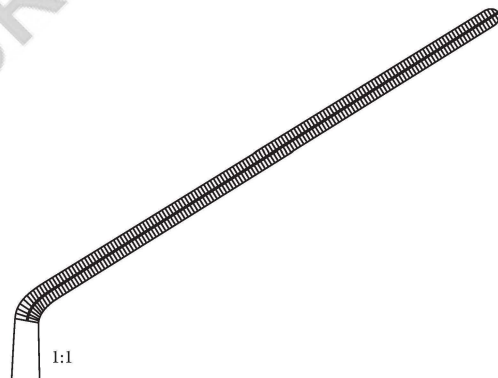
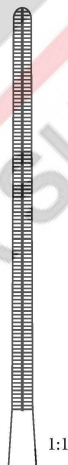

COOLEY

180 mm – 7"	185 mm – 7 ¹ / ₄ "
CV 07-400-01	CV 07-400-02

straight

angled on flat

Gefäßklemmen
Vascular forceps
Pinces vasculaires
Pinzas vasculares
Pinze vascolari



COOLEY-TANGENTIAL

195 mm - 7 ³ / ₄ "	255 mm - 10"	260 mm - 10 ¹ / ₄ "
CV 07-405-01	CV 07-405-02	CV 07-405-03

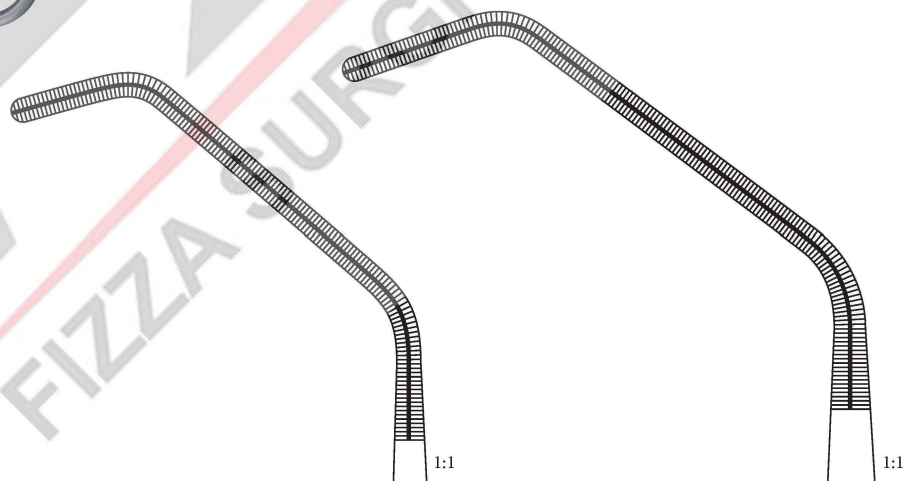

265 mm - 10 ¹ / ₂ "	270 mm - 10 ³ / ₄ "
CV 07-405-04	CV 07-405-05

Mehrzweckklemmen, pädiatrisch, graduiert
Multi-purpose clamps, pediatric, graduated
Pinces polyvalentes, pédiatriques, graduées
Pinzas de uso vario, pediátricas, graduadas
Pinze multi uso, per bambini, graduati



COOLEY

	165 mm – 6 $\frac{1}{2}$ "	160 mm – 6 $\frac{1}{4}$ "	145 mm – 5 $\frac{3}{4}$ "
	25°	45°	90°
	CV 07-410-01	CV 07-410-02	CV 07-410-03

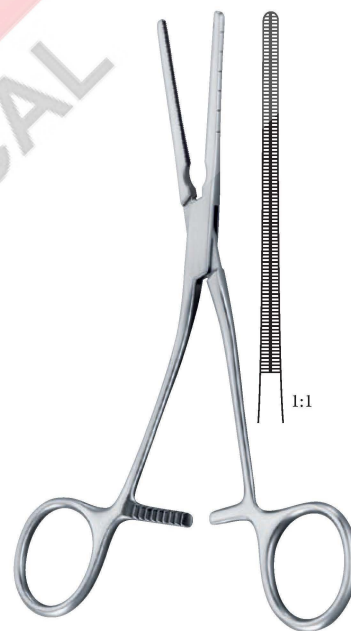
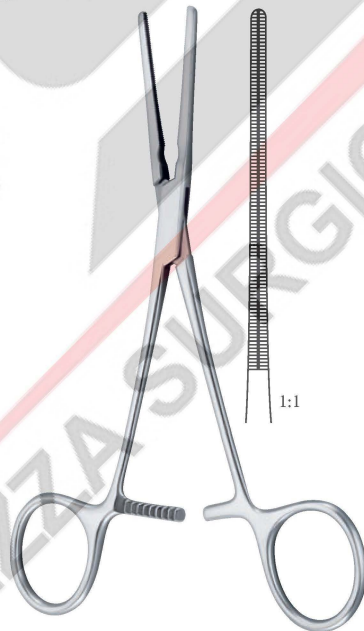
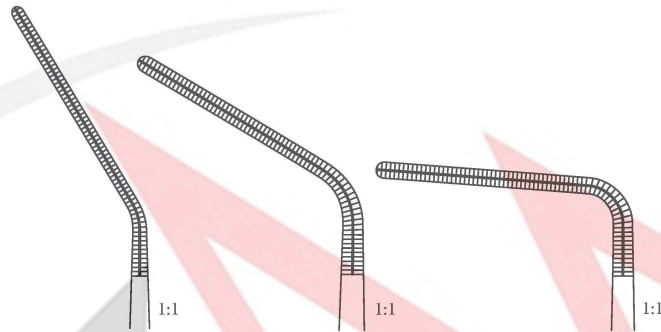

**COOLEY PATENT
DUCTUS CLAMP**

160 mm – 6 $\frac{1}{4}$ "	CV 07-415-01	CV 07-416-01
170 mm – 6 $\frac{3}{4}$ "	CV 07-415-02	CV 07-416-02
200 mm – 8"	CV 07-415-03	
210 mm – 8 $\frac{1}{4}$ "	CV 07-415-04	
230 mm – 9"	CV 07-415-05	CV 07-416-05

Angled on flat, Graduated

Mehrzweckklemmen, pädiatrisch, graduiert
Multi-purpose clamps, pediatric, graduated
Pinces polyvalentes, pédiatriques, graduées
Pinzas de uso vario, pediátricas, graduadas
Pinze multi uso, per bambini, graduati

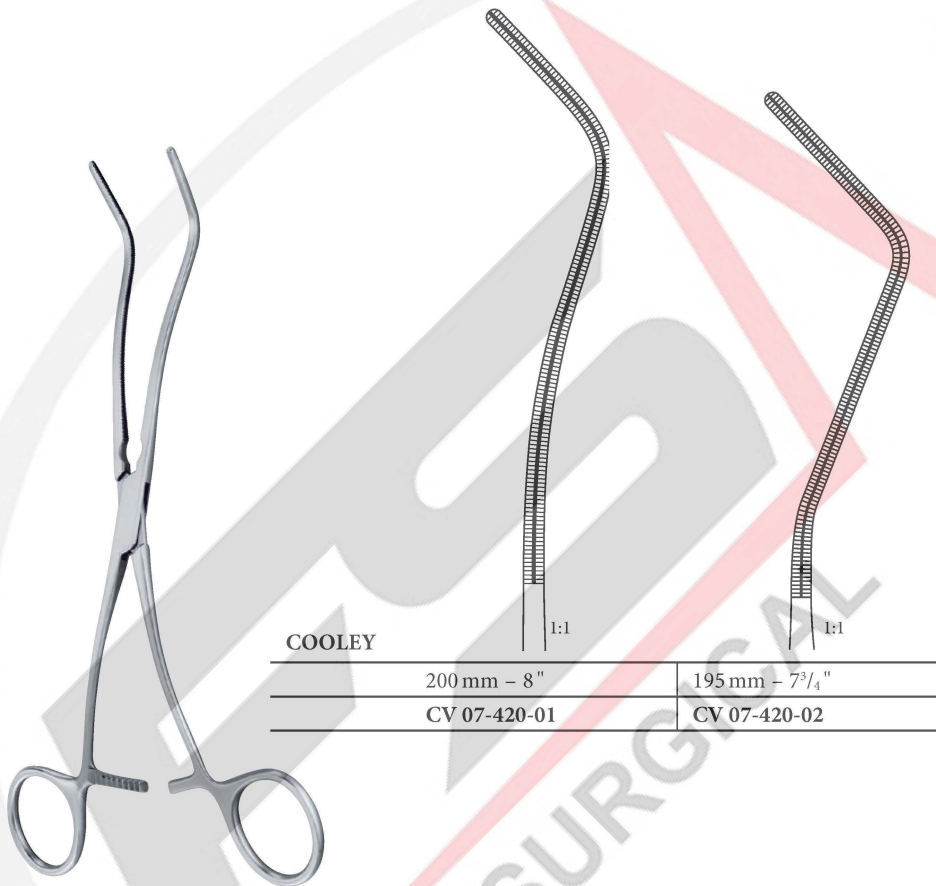

COOLEY

200 mm – 8"

CV 07-420-01

195 mm – 7³/₄"

CV 07-420-02

Mehrzweckklemmen
Multi-purpose clamps
Pinces clamps polyvalentes
Pinzas clamps para usos varios
Pinze multi uso

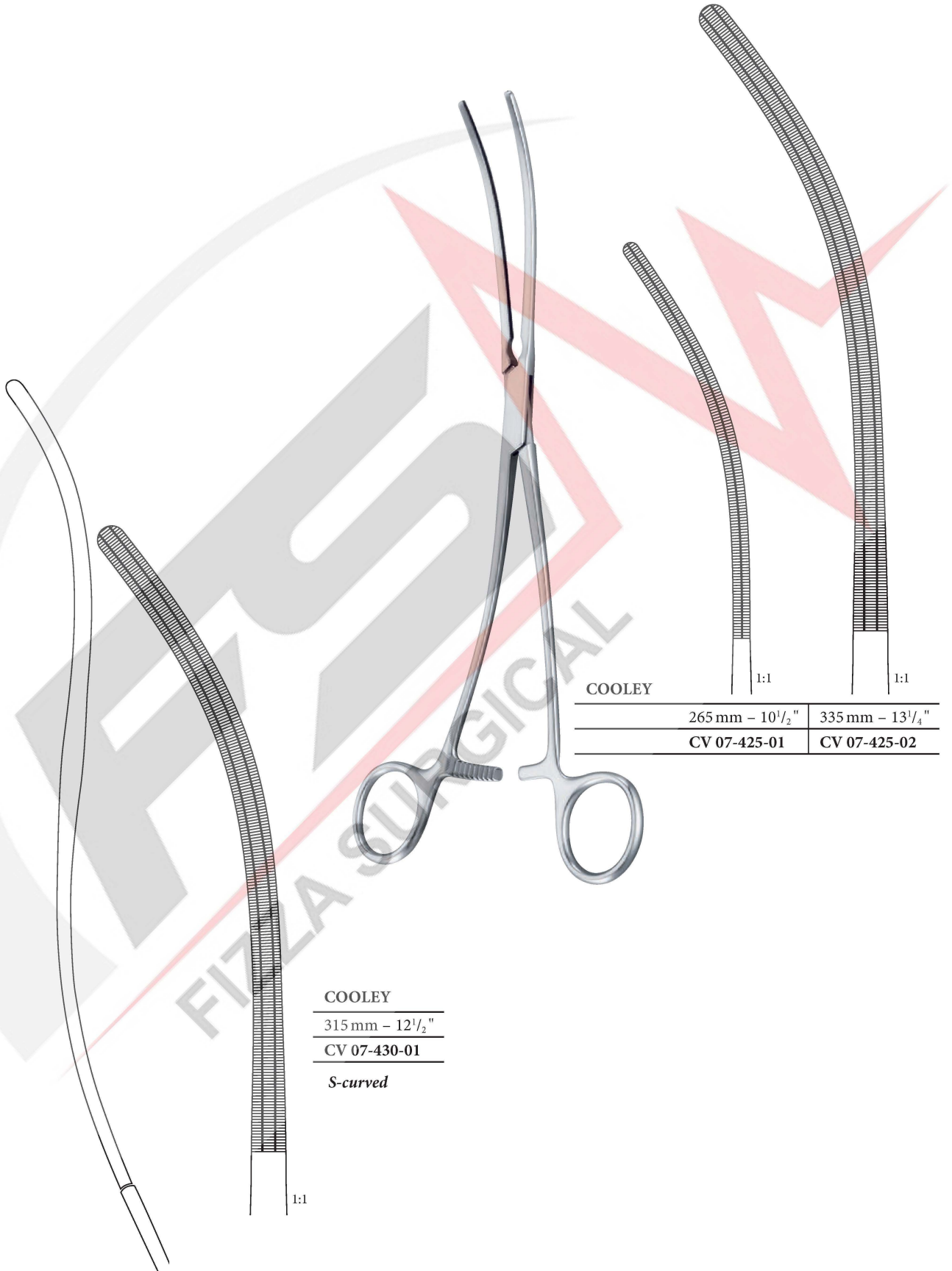

COOLEY

265 mm - 10¹/₂"

335 mm - 13¹/₄"

CV 07-425-01

CV 07-425-02

COOLEY

315 mm - 12¹/₂"

CV 07-430-01

S-curved